



**ROHDE & SCHWARZ**

Test and Measurement  
Division

## Operating Manual

# EMI Test Receiver

## ESPI3

1142.8007.03

## ESPI7

1142.8007.07

Printed in the Federal  
Republic of Germany

Microsoft, Windows NT, DOS and Internet Explorer are trademarks or registered trademarks of Microsoft Corporation.  
GPIB is a trademark or a registered trademark of National Instruments.  
Norton AntiVirus and PCAnywhere are trademarks or registered trademarks of Symantec Corporation

# Tabbed Divider Overview

## Contents

### Data Sheet

Safety Instructions  
Certificate of Quality  
EU Certificate of Conformity  
List of R&S Representatives

### Manuals for Test Receiver ESPI

### Tabbed Divider

<b>1</b>	<b>Chapter 1: Putting into Operation</b>
<b>2</b>	<b>Chapter 2: Getting Started</b>
<b>3</b>	<b>Chapter 3: Operation</b>
<b>4</b>	<b>Chapter 4: Functional Description</b>
<b>5</b>	<b>Chapter 5: Remote Control – Basics</b>
<b>6</b>	<b>Chapter 6: Remote Control – Commands</b>
<b>7</b>	<b>Chapter 7: Remote Control – Program Examples</b>
<b>8</b>	<b>Chapter 8: Maintenance and Hardware Interfaces</b>
<b>9</b>	<b>Chapter 9: Error Messages</b>
<b>10</b>	<b>Index</b>











## Safety Instructions

This unit has been designed and tested in accordance with the EC Certificate of Conformity and has left the manufacturer's plant in a condition fully complying with safety standards.

To maintain this condition and to ensure safe operation, the user must observe all instructions and warnings given in this operating manual.

### Safety-related symbols used on equipment and documentation from R&S:

							
Observe operating instructions	Weight indication for units >18 kg	PE terminal	Ground terminal	Danger! Shock hazard	Warning! Hot surfaces	Ground	Attention! Electrostatic sensitive devices require special care

1. The unit may be used only in the operating conditions and positions specified by the manufacturer. Unless otherwise agreed, the following applies to R&S products:  
IP degree of protection 2X, pollution severity 2 overvoltage category 2, only for indoor use, altitude max. 2000 m.  
The unit may be operated only from supply networks fused with max. 16 A.  
Unless specified otherwise in the data sheet, a tolerance of  $\pm 10\%$  shall apply to the nominal voltage and of  $\pm 5\%$  to the nominal frequency.
2. For measurements in circuits with voltages  $V_{\text{rms}} > 30 \text{ V}$ , suitable measures should be taken to avoid any hazards.  
(using, for example, appropriate measuring equipment, fusing, current limiting, electrical separation, insulation).
3. If the unit is to be permanently wired, the PE terminal of the unit must first be connected to the PE conductor on site before any other connections are made. Installation and cabling of the unit to be performed only by qualified technical personnel.
4. For permanently installed units without built-in fuses, circuit breakers or similar protective devices, the supply circuit must be fused such as to provide suitable protection for the users and equipment.
5. Prior to switching on the unit, it must be ensured that the nominal voltage set on the unit matches the nominal voltage of the AC supply network.  
If a different voltage is to be set, the power fuse of the unit may have to be changed accordingly.
6. Units of protection class I with disconnectible AC supply cable and appliance connector may be operated only from a power socket with earthing contact and with the PE conductor connected.
7. It is not permissible to interrupt the PE conductor intentionally, neither in the incoming cable nor on the unit itself as this may cause the unit to become electrically hazardous.  
Any extension lines or multiple socket outlets used must be checked for compliance with relevant safety standards at regular intervals.
8. If the unit has no power switch for disconnection from the AC supply, the plug of the connecting cable is regarded as the disconnecting device. In such cases it must be ensured that the power plug is easily reachable and accessible at all times (length of connecting cable approx. 2 m). Functional or electronic switches are not suitable for providing disconnection from the AC supply.  
If units without power switches are integrated in racks or systems, a disconnecting device must be provided at system level.
9. Applicable local or national safety regulations and rules for the prevention of accidents must be observed in all work performed.  
Prior to performing any work on the unit or opening the unit, the latter must be disconnected from the supply network.  
Any adjustments, replacements of parts, maintenance or repair may be carried out only by authorized R&S technical personnel.

continued overleaf

## Safety Instructions

- Only original parts may be used for replacing parts relevant to safety (eg power switches, power transformers, fuses). A safety test must be performed after each replacement of parts relevant to safety.  
(visual inspection, PE conductor test, insulation-resistance, leakage-current measurement, functional test).
10. Ensure that the connections with information technology equipment comply with IEC950 / EN60950.
  11. Lithium batteries must not be exposed to high temperatures or fire.  
Keep batteries away from children.  
If the battery is replaced improperly, there is danger of explosion. Only replace the battery by R&S type (see spare part list).  
Lithium batteries are suitable for environmentally-friendly disposal or specialized recycling. Dispose them into appropriate containers, only.  
Do not short-circuit the battery.
  12. Equipment returned or sent in for repair must be packed in the original packing or in packing with electrostatic and mechanical protection.
  13. Electrostatics via the connectors may damage the equipment. For the safe handling and operation of the equipment, appropriate measures against electrostatics should be implemented.
  14. The outside of the instrument is suitably cleaned using a soft, lint-free dustcloth. Never use solvents such as thinners, acetone and similar things, as they may damage the front panel labeling or plastic parts.
  15. Any additional safety instructions given in this manual are also to be observed.

## Supplement A to Operating Manual EMI Test Receiver ESPI3 and ESPI7 (Firmware Version 1.72)

### Dear Customer,

As far as the functionality of ESPI is concerned, the following new and modified functions are not yet described in the operating manual.

- Automatic final measurement with *THRESHOLD SCAN* (page [A](#))
- New status messages (page [E](#))
- Number of sweep points selectable (page [F](#))
- Linear dB scaling (page [G](#))
- Support for Multi Carrier Channel Power measurements (page [I](#))
- Trigger line remains on screen after leaving the TRIG menu (page [Z](#))
- Extended IEC/IEEE bus command (page [AA](#))
- Extended # of frequency points (200 now!) with function SENSE:LIST (page [EE](#))

### Automatic Final Measurement with *THRESHOLD SCAN*

The interference spectrum is first pre-analyzed in a fast prescan to optimize the duration of the measurement. If the measured level exceeds a limit line, or violates a margin defined for this line, the time-consuming final measurement is performed. The final measurement is, therefore, carried out only for a reduced number of frequencies of interest. For this measurement, each scan trace to be taken into account has to be assigned a limit line, and the limit line and the limit check function have to be activated in the *LIMIT LINE* menu.

The prescan is interrupted immediately for each final measurement to be performed, i.e. the final measurement immediately follows the prescan measurement. In the case of drifting or fluctuating interferers, this increases the probability that the signal of interest will be reliably detected in the final measurement.

If the narrowband/broadband discrimination function is activated (NB/BB DISCR softkey), the receiver automatically selects the detector to use in the final measurement. To this end, the receiver compares the positive and the negative peak value obtained in the prescan. If the difference between the two values exceeds a user-selected threshold, a broadband interferer is assumed, and the quasi-peak detector is used in the final measurement. If the difference falls below this threshold, a narrowband interferer is assumed, and the average detector is used in the final measurement. (The receiver automatically determines the positive and the negative peak value during the prescan.)

The value obtained in the final measurement is added to the peak list, where it replaces the result of the prescan. With *NO OF PEAKS*, the maximum number of peak values to be included in the list can be defined. If this number is attained, the prescan will be continued, but no further final measurements will be performed.

The *THRESHOLD SCAN* submenu is called from the *RECEIVER* main menu:

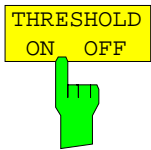
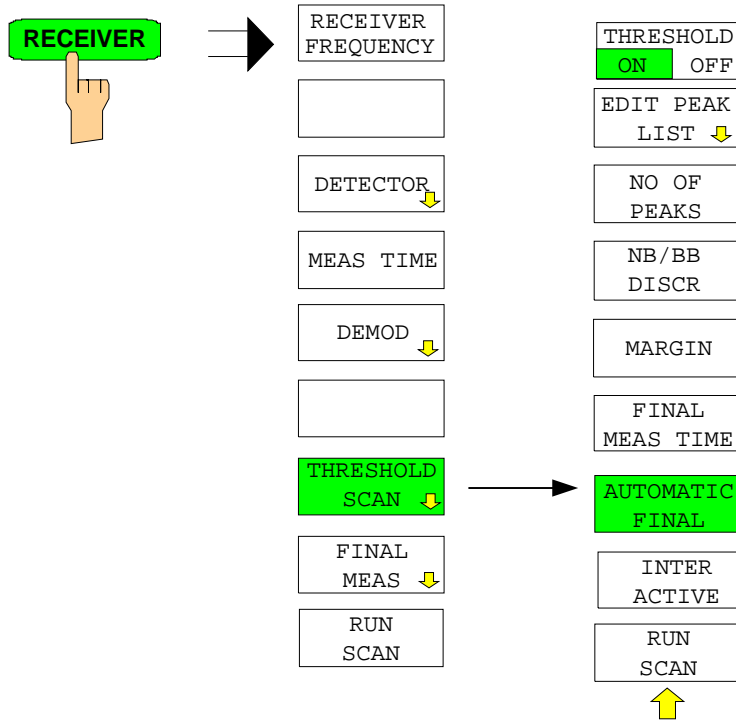

The *THRESHOLD ON OFF* softkey activates or deactivates the *THRESHOLD SCAN* measurement function. This function will also be activated on opening the submenu with the *THRESHOLD SCAN* softkey from the *RECEIVER* main menu.

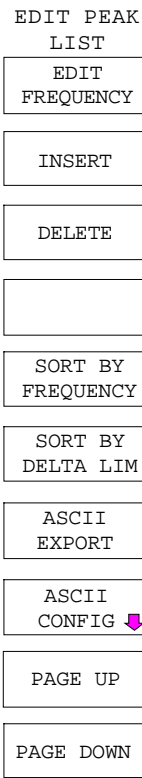

The *EDIT PEAK LIST* softkey calls the *EDIT PEAK LIST* submenu used for editing the peak list.

Further functions relating to the peak list are described in the operating manual, section "*Data Reduction by Generating Subrange Maxima*".

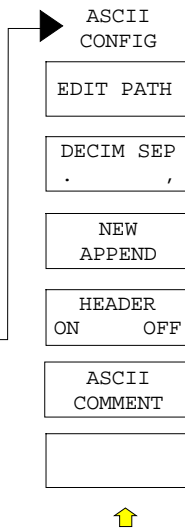



NO OF  
PEAKS



With the *NO OF PEAKS* softkey, you can enter the number of final measurement peaks to be stored. Numbers between 1 and 500 can be entered. If the selected number is attained, no further final measurements will be performed.

IEC/IEEE-bus command :CALC:PEAK:SUBR 1...500

NB/BB  
DISCR



With the *NB/BB DISCR* softkey, you can enter the decision threshold to be used by the analyzer to discriminate between broadband and narrowband interference. Values between 0 dB and 200 dB can be entered.

IEC/IEEE-bus command --

MARGIN



The *MARGIN* softkey activates the entry field of the margin, i.e. of an additional acceptance threshold for the determination of the peak list. The limit line currently used is shifted by this amount for defining the maxima. The range of values is -200 dB to 200 dB.

IEC/IEEE-bus command :CALC:PEAK:MARG -200dB...200dB

FINAL  
MEAS TIME



The *FINAL MEAS TIME* softkey activates the entry field of the time of final measurement.

IEC/IEEE-bus command :SWE:TIME:FME <num\_value>

AUTOMATIC  
FINAL



The *AUTOMATIC FINAL* softkey activates the automatic mode for the final measurement, i.e. a final measurement will be performed automatically and immediately each time a value out of limit is detected.

IEC/IEEE-bus command --

INTER  
ACTIVE



The *INTERACTIVE* softkey selects the following sequence for the final measurement:

- The prescan is interrupted – *HOLD SCAN* state.
- The bar graph measurement is started in the free running mode.
- The signal can be exactly analyzed by modifying the receiver settings.
- The actual final measurement is started, the receiver settings being restored except the frequency.
- The current frequency replaces the original one in the frequency list (drifting interference sources).
- The prescan is continued at the frequency at which it was interrupted....

**Note:** With the *AUTOMATIC FINAL* softkey in the *CONTINUE FINAL MEAS* submenu a switchover can be made to the automatic mode before the measurement is started anew.

IEC/IEEE-bus command --

Sequence for *AUTOMATIC FINAL*:

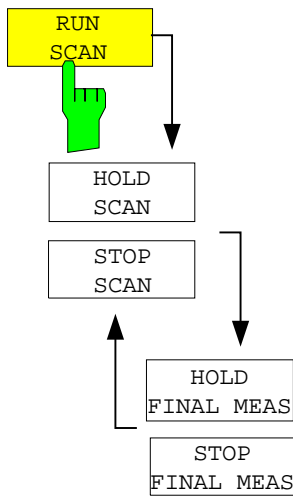

The *RUN SCAN* softkey starts the prescan. The *HOLD SCAN* submenu is called.

If an out-of-limit value is detected, the receiver automatically goes to the *HOLD SCAN* state and starts the final measurement. The *HOLD FINAL MEAS* submenu comes up. On completion of the final measurement, the receiver continues the prescan, and the *HOLD SCAN* submenu is displayed again.

Sequence for *INTERACTIVE*:

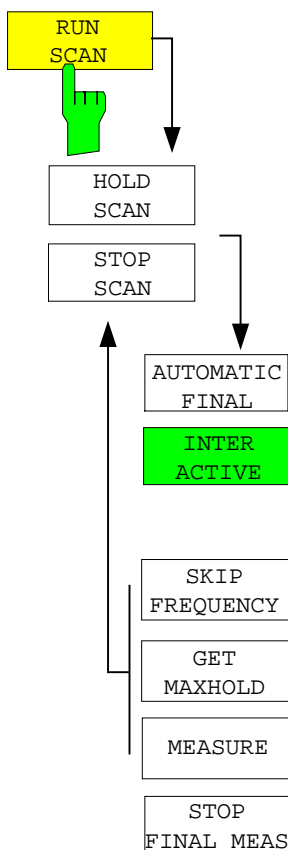

The *RUN SCAN* softkey starts the prescan. The *HOLD SCAN* submenu is called.

If an out-of-limit value is detected, the receiver automatically goes to the *HOLD SCAN* state. A submenu with several options for the final measurement comes up:

- *AUTOMATIC FINAL* activates the automatic final measurement mode for the rest of the test run.
- *SKIP FREQUENCY* skips the final measurement and continues with the prescan.
- *GET MAXHOLD* accepts the highest level measured during the *HOLD SCAN* state as the result of the final measurement and continues the prescan. (The level value in question is displayed as a small bar in the bar graph.)
- *MEASURE* starts the final measurement, the receiver settings being restored except the frequency.
- *STOP FINAL MEAS* aborts the final measurement and the prescan.

The table shows a peak list:

EDIT PEAK LIST (Final Measurement Results)			
Trace1: 014QP			
Trace2: 014AV			
TRACE3: ---			
TRACE	FREQUENCY	LEVEL dBpT	DELTA LIMIT dB
1 Average	80.0000 MHz	29.99	-9.25
2 Average	89.4800 MHz	35.64	-4.09
1 Quasi Peak	98.5200 MHz	49.94	-0.22
2 Average	98.5200 MHz	48.32	8.15
1 Quasi Peak	100.7200 MHz	55.33	5.07
2 Average	102.3200 MHz	50.86	10.53
1 Quasi Peak	113.2400 MHz	42.50	-8.26
2 Average	116.9200 MHz	44.44	3.53
1 Quasi Peak	125.8800 MHz	54.91	3.68
2 Average	125.8800 MHz	53.86	12.64
1 Quasi Peak	138.4800 MHz	41.83	-9.81
2 Average	138.4800 MHz	39.38	-2.25
2 Average	144.0400 MHz	40.77	-1.04
2 Average	167.0400 MHz	44.82	2.37
2 Average	176.2400 MHz	46.56	3.87
1 Quasi Peak	200.4800 MHz	50.93	-2.31
2 Average	200.4800 MHz	48.27	5.02
1 Quasi Peak	210.2800 MHz	58.71	5.25
2 Average	226.5600 MHz	59.07	15.29
2 Average	230.0000 MHz	46.90	3.05

In the *THRESHOLD SCAN* mode, with the *NB/BB DISCR* function active, the receiver automatically selects the detector to be used in the final measurement on the basis of the results obtained in the prescan.

## New Status Messages/Trace Info

**Note:** Status message MSG is omitted

### #SMPL

"#SMPL" indicates that the relation Span / RBW is higher than 125 while the RMS detector is activated. In this case a stable signal evaluation is no longer possible due to an insufficient number of A/D converter samples.

⇒ reduce span or increase RBW

### Trace-Info:

Every active measurement curve (trace ≠ BLANK) is allocated trace information of two or three lines at the left of the diagram. The trace information has the same color as the measurement curve.

**The information on the currently selected trace is displayed in inverse video (see TRACE - SELECT TRACE softkey).**

# Number of Sweep Points Selectable

The SWEEP menu was extended by the SWEEP POINTS softkey.

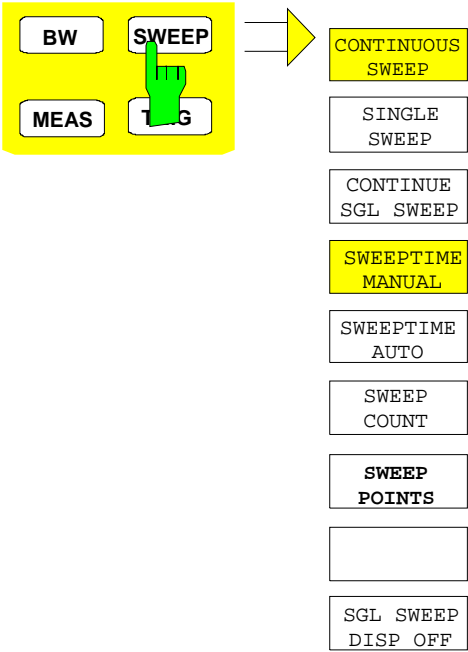

The SWEEP key calls a menu in which the sweep mode is defined. In split-screen mode, the entries made are valid for the active window only.

The CONTINUOUS SWEEP, SINGLE SWEEP and SGL SWEEP DISP OFF softkeys are mutually exclusive selection keys.

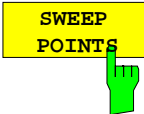

The SWEEP POINTS softkey selects the number of measurement samples acquired during a sweep.

The following numbers of points per sweep are available: 125, 251, 501 (default), 1001, 2001, 4001, 8001

**Note:**  
*The autopeak detector will be disabled while the number of points per sweep is  $\neq$  501.*

IEC/IEEE-bus command:           SWE:POIN 501

## Linear dB scaling

The *AMPT* menu was extended by the *RANGE LINEAR* submenu.

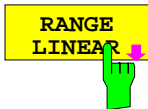
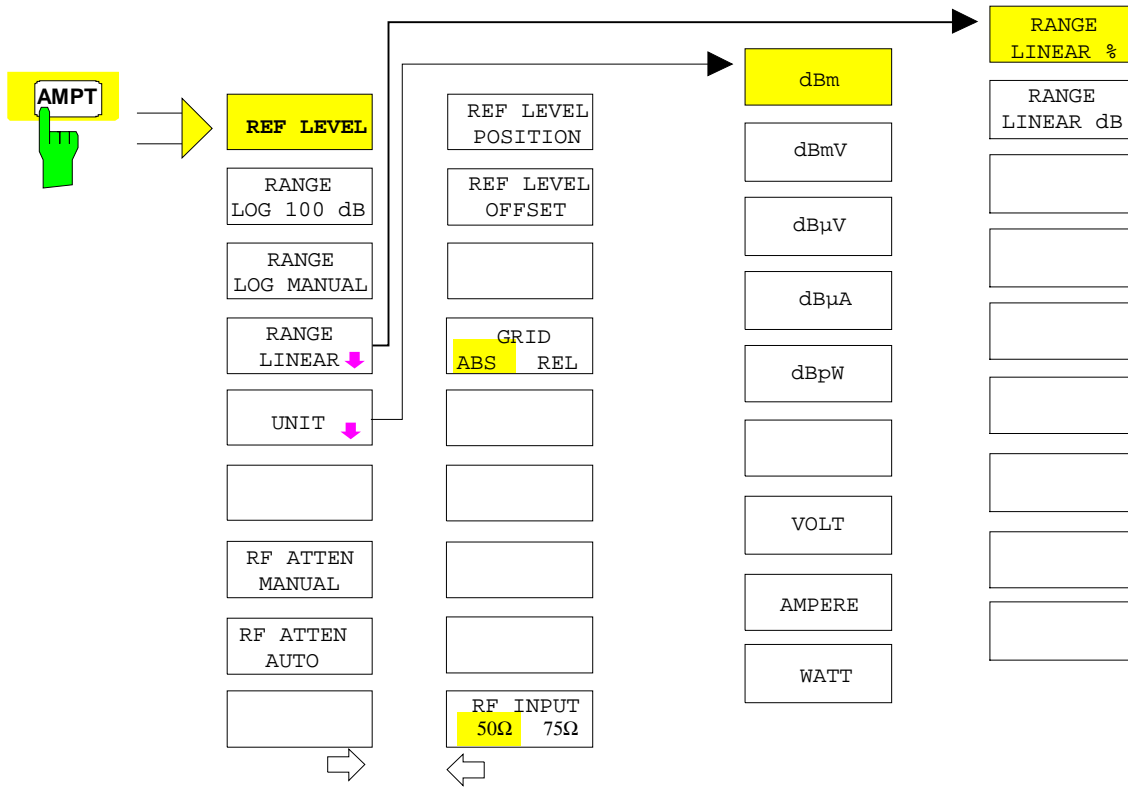

The *RANGE LINEAR* softkey selects linear scaling for the level display range of the analyzer. In addition, it opens a submenu for selecting % or dB for the scaling.

When linear scaling is selected, the % scaling is first activated (see also *RANGE LINEAR dB* softkey).

IEC/IEEE-bus command: `DISP:WIND:TRAC:Y:SPAC LIN`

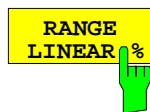

The *RANGE LINEAR %* softkey selects linear scaling in % for the level display range, i.e. the horizontal lines are labelled in %. The grid is divided into decades. Markers are displayed in the selected unit; delta markers are displayed in % referenced to the voltage value at the position of marker 1.

IEC/IEEE-bus command:  
`DISP:WIND:TRAC:Y:SPAC LIN`

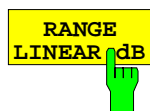

The *RANGE LINEAR dB* softkey selects linear scaling in dB for the level display range, i.e. the horizontal lines are labelled in dB. Markers are displayed in the selected unit; delta markers are displayed in dB referenced to the power value at the position of marker 1.

IEC/IEEE-bus command:  
`DISP:WIND:TRAC:Y:SPAC LDB`

## Modified softkey menu MKR->

In the MRK-> menus of Receiver and Analyzer mode, the softkeys *NEXT PEAK*, *NEXT PEAK LEFT*, *NEXT PEAK RIGHT*, *NEXT MIN*, *NEXT MIN LEFT*, *NEXT MIN RIGHT* were re-ordered for easier operation.

### Receiver Mode:

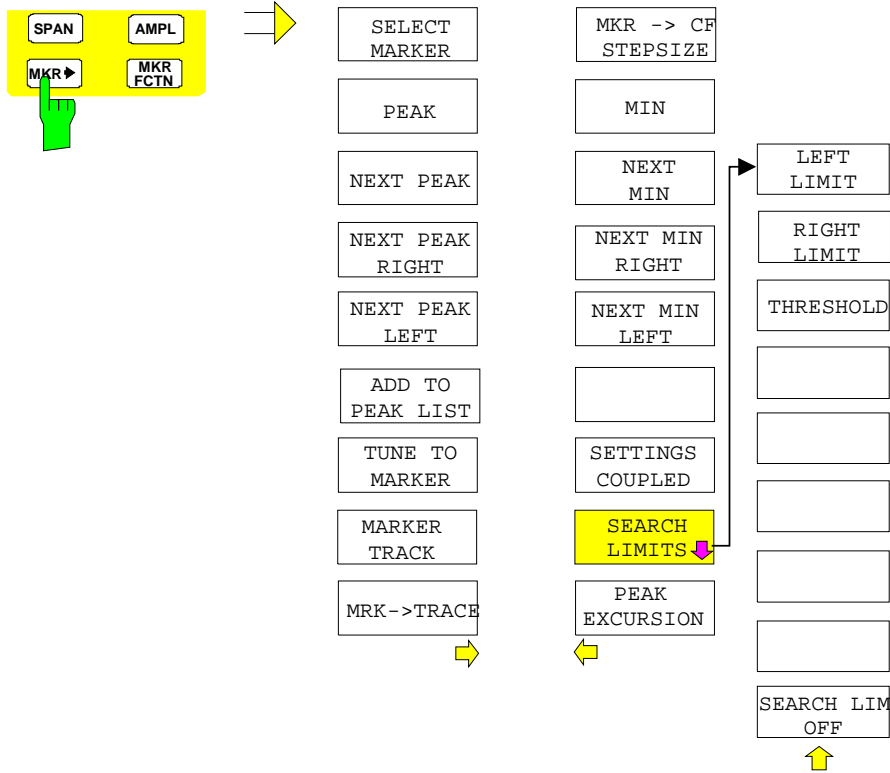

### Analyzer Mode:

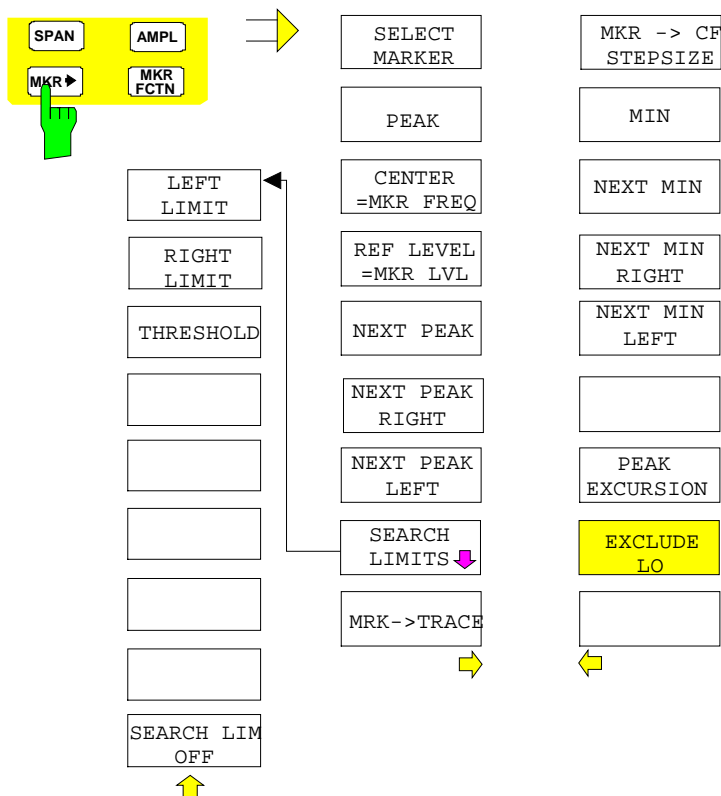

## Support for Multi Carrier Channel Power measurements

The *MEAS* menu was extended by the **MULT CARR ACP** submenu. In the following, the complete submenus *CHAN PWR ACP* and *MULT CARR ACP* are described. The modifications are displayed in bold types.

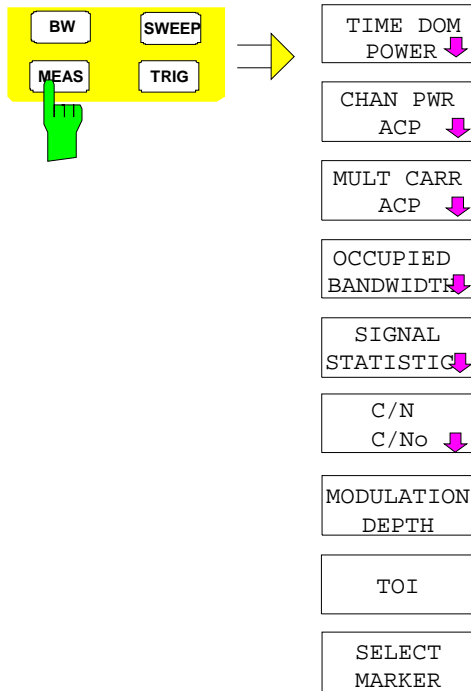

The *MEAS* key opens the menu to select and set the power measurement.

The following measurements can be selected:

- Power in time domain (*TIME DOM POWER*)
- Channel power and adjacent-channel power in the frequency domain **with a single carrier** (*CHAN PWR ACP*)
- **Channel power and adjacent-channel power in the frequency domain with several carriers** (***MULT CARR ACP***)
- Occupied bandwidth (*OCCUPIED BANDWIDTH*)
- Amplitude probability distribution (*SIGNAL STATISTICS*)
- Carrier/noise ratio (*C/N, C/No*)
- Modulation depth (*MODULATION DEPTH*)
- 3<sup>rd</sup> order intercept (*TOI*)

The above measurements are carried out alternatively.

## Channel and Adjacent-Channel Power Measurements

For all channel and adjacent-channel power measurements a specified channel configuration is assumed which is for instance based on a specific radio communication system.

This configuration is defined by the nominal channel frequency (= center frequency of the ESPI **if only one carrier is active**), the channel bandwidth, **the channel spacing**, the adjacent-channel bandwidth and the adjacent-channel spacing. The ESPI is able to simultaneously measure the power **in up to four transmission channels** and up to three adjacent channels (**10 channels: 4 transmission channels, 3 lower and 3 upper adjacent channels**).

It offers two methods for channel and adjacent-channel power measurement:

- The integrated bandwidth method (IBW method), i.e. the integration of trace pixels within the bandwidth of the channel to be measured to the total power of the channel,
- The measurement in time domain (Fast ACP) by means of steep resolution filters simulating the channel.

The two measurements yield the same results. The measurement in time domain can be performed much faster since the complete signal is measured within a channel at the same time. With the IBW method, the channel is divided into subspectra. This is done by means of a bandwidth which is small compared to the channel bandwidth. These subspectra are then combined by integration of the trace pixels.

With the IBW method, the transmission channels or adjacent channels are marked by vertical lines at a distance of half the channel bandwidth to the left and to the right of the corresponding channel center frequency. The boundaries of the channels are marked by vertical lines. (see Fig. 1).

With the time-domain method, the power versus time is shown for each channel. (see Fig. 2).

For both methods, the results are listed in tables in the lower half of the screen.

The ESPI offers predefined standard settings which can be selected from a table for the common mobile radio standards. Thus, channel configuration is performed automatically without the need to enter the corresponding parameters manually.

For some standards, the channel power and the adjacent-channel power are to be weighted by means of a root-raised cosine filter corresponding to a receive filter. This type of filtering is switched on automatically for both methods on selecting the standard (e.g. NADC, TETRA or 3GPP W-CDMA).

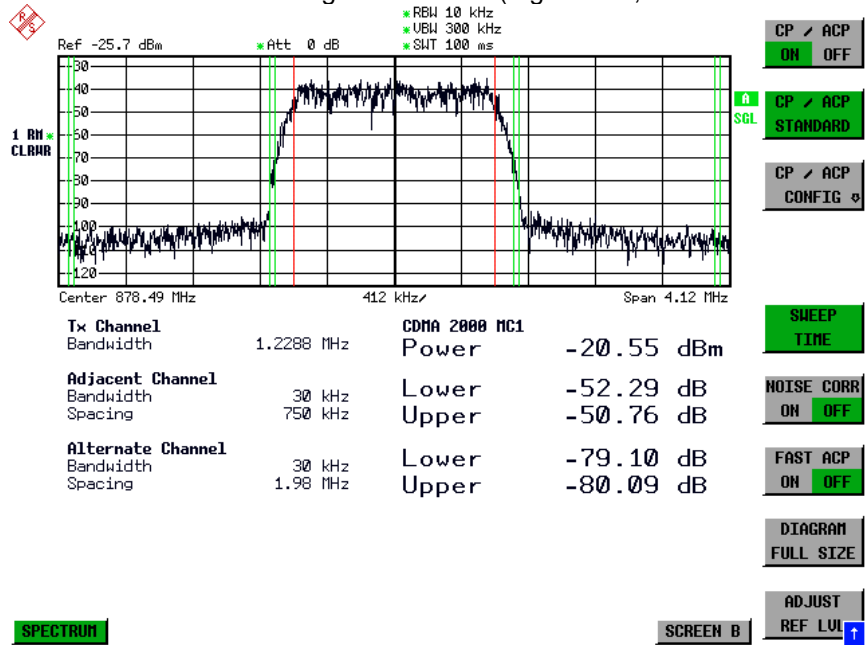

Fig. 1 Screen display of adjacent-channel power measurement using the IBW method

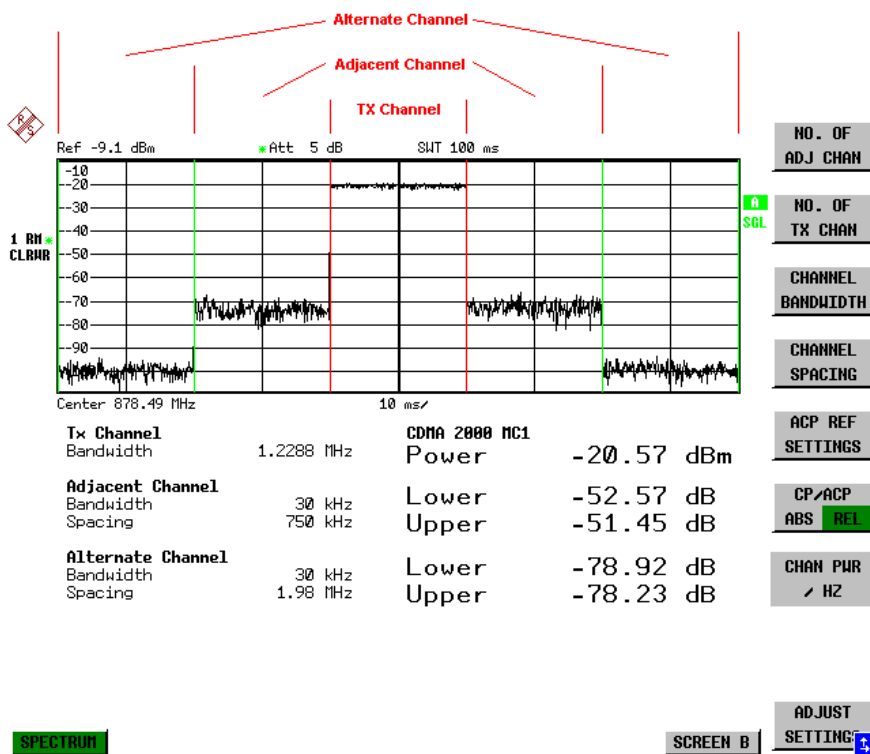

Fig. 2 Screen display of adjacent-channel power measurement using the time-domain method

Limit values for the adjacent-channel power can be defined for the measurement. If limit checking is switched on, a pass/fail information indicating that the power has been exceeded is displayed during the measurement in the table in the lower half of the screen.



**Note:** With the CP/ACP measurement switched on the functions SPLIT SCREEN and FULL SCREEN are inhibited.

The channel configuration is defined in the MEAS - CHAN PWR ACP or the MEAS - MULT CARR ACP menu.

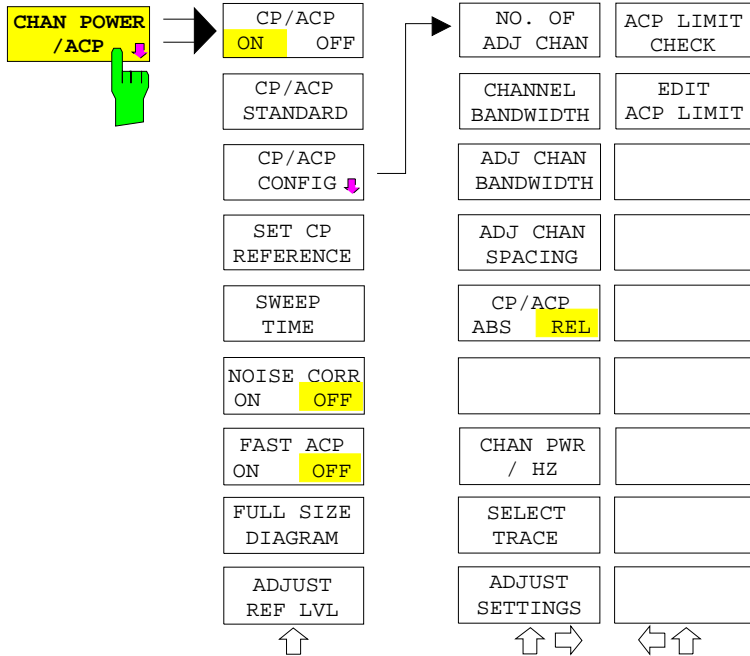

The **CHAN PWR ACP** and **MULT CARR ACP** softkeys activate channel or adjacent-channel power measurement either for a single carrier signal (**CHAN PWR ACP**) or for several carrier signals (**MULT CARR ACP**), depending on the current measurement configuration. In addition, they open a submenu for defining the parameters for channel power measurement. The softkey selected is shown in color to indicate that a channel or adjacent-channel power measurement is active.

**Note:** The softkeys are available only for measurements in the frequency domain (span > 0).

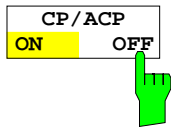

The **CP/ACP ON/OFF** softkey switches calculation of the channel power or adjacent-channel power on and off.

With default settings the measurement is performed by integrating the powers at the display points within the specified channels (IBW method).

The powers of the adjacent channels are measured either as absolute values or as relative values referenced to the power of a transmission channel. The default setting is relative-value measurement (see **CP/ACP ABS/REL** softkey).

**When multicarrier ACP measurement is activated, the number of test points is increased to ensure that adjacent-channel powers are measured with adequate accuracy.**

IEC/IEEE-bus commands: `CALC:MARK:FUNC:POW:SEL CPOW|ACP|MCAC`  
`CALC:MARK:FUNC:POW:RES? CPOW|ACP|MCAC`  
`CALC:MARK:FUNC:POW OFF`

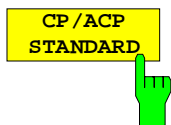

The **CP/ACP STANDARD** softkey opens a table for the selection of the settings according to predefined standards. The test parameters for the channel and adjacent-channel measurements are set according to the mobile radio standard.

ACP STANDARD
✓ NONE
NADC IS136
TETRA
PDC
PHS
CDPD
CDMA IS95A FWD
CDMA IS95A REV
CDMA IS95C Class 0 FWD
CDMA IS95C Class 0 REV
CDMA J-STD008 FWD
CDMA J-STD008 REV
CDMA IS95C Class 1 FWD
CDMA IS95C Class 1 REV
W-CDMA 4.096 FWD
W-CDMA 4.096 REV
W-CDMA 3GPP FWD
W-CDMA 3GPP REV
CDMA 2000 DS
CDMA 2000 MC1
CDMA 2000 MC3
TD-SCDMA

The standards available are listed in the table on the left.

**Note:** For the ESPI, the channel spacing is defined as the distance between the center frequency of the adjacent channel and the center frequency of the transmission channel. The definition of the adjacent-channel spacing in standards IS95 B and C, IS97 B and C and IS98 B and C is different. These standards define the adjacent-channel spacing from the center of the transmission channel to the closest border of the adjacent channel. This definition is also used for the ESPI when the following standard settings are selected:

- CDMA IS95 Class 0 FWD
- CDMA IS95 Class 0 REV
- CDMA IS95 Class 1 FWD
- CDMA IS95 Class 1 REV

The selection of the standard influences the following parameters:

- channel spacing **and adjacent-channel spacing**
- channel bandwidth, **adjacent-channel bandwidth**, and type of filtering
- resolution bandwidth
- video bandwidth
- detector
- # of adjacent channels

Trace mathematics and trace averaging are switched off.

The reference level is not influenced by the selection of a standard. To achieve an optimum dynamic range, the reference level has to be set in a way that places the signal maximum close to the reference level without forcing an overload message.

The default setting is CP/ACP STANDARD NONE.

IEC/IEEE-bus command:            CALC:MARK:FUNC:POW:PRES <standard>

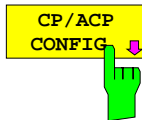

See following section "Setting the Channel Configuration"

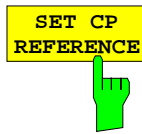

With channel power measurement activated, the *SET CP REFERENCE* softkey defines the currently measured channel power as the reference value. The reference value is displayed in the *CH PWR REF* field; the default value is 0 dBm.

**In adjacent-channel power measurement with one or several carrier signals, the power is always referenced to a transmission channel, i.e. no value is displayed for *CH PWR REF*.**

IEC/IEEE-bus command: `POW:ACH:REF:AUTO ONCE`

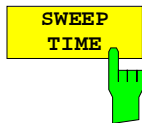

The *SWEEP TIME* softkey activates the entry of the sweep time. With the RMS detector, a longer sweep time increases the stability of the measurement results. The function of the softkey is identical to the softkey *SWEEP TIME MANUAL* in the menu *BW*.

IEC/IEEE-bus command: `SWE:TIM <value>`

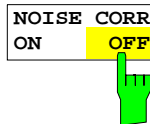

If the *NOISE CORR ON/OFF* softkey is activated, the results will be corrected by the instrument's inherent noise, which increases the dynamic range.

When the function is switched on, a reference measurement of the instrument's inherent noise is carried out. The noise power measured is then subtracted from the power in the channel that is being examined.

The inherent noise of the instrument depends on the selected center frequency, resolution bandwidth and level setting. Therefore, the correction function is disabled whenever one of these parameters is changed. A disable message is displayed on the screen.

To enable the correction function in conjunction with the changed setting, press the softkey once more. A new reference measurement is carried out.

IEC/IEEE-bus command: `SENS:POW:NCOR ON`

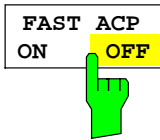

The *FAST ACP* softkey switches between the IBW method (*FAST ACP OFF*) and the time domain method (*FAST ACP ON*).

With *FAST ACP ON* the power measurement is performed in the different channels in the time domain. The ESPI sets the center frequency consecutively to the different channel center frequencies and measures the power with the selected measurement time (= sweep time/number of channels). The RBW filters suitable for the selected standard and frequency offset are automatically used (e.g. root raised cos with IS 136). The list of available channel filters is included in section "Setting of Bandwidths and Sweep Time – *BW key*".

The RMS detector is used for obtaining correct power measurement results. Therefore this requires no software correction factors.

**Measured values are output as a list. The powers of the transmission channels are output in dBm, the powers of the adjacent channels in dBm (*CP/ACP ABS*) or dB (*CP/ACP REL*).**

The sweep time is selected depending on the desired reproducibility of results. Reproducibility increases with sweep time since power measurement is then performed over a longer time period.

As a general approach, it can be assumed that approx. 500 non-correlated measured values are required for a reproducibility of 0.5 dB (99% of the measurements are within 0.5 dB of the true measured value). This holds true for white noise. The measured values are considered as non-correlated when their time interval corresponds to the reciprocal of the measured bandwidth.

With IS 136 the measurement bandwidth is approx. 25 kHz, i.e. measured values at an interval of 40  $\mu$ s are considered as noncorrelated. A measurement time of 20 ms is thus required per channel for 1000 measured values. This is the default sweep time which the ESPI sets in coupled mode. Approx. 5000 measured values are required for a reproducibility of 0.1 dB (99%), i.e. the measurement time is to be increased to 200 ms.

IEC/IEEE-bus command            `SENS:POW:HSP ON`

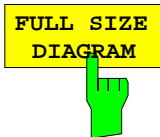

The *FULL SIZE DIAGRAM* softkey switches the diagram to full screen size.

IEC/IEEE-bus command:            `DISP:WIND1:SIZE LARG|SMAL`

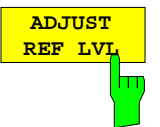

The *ADJUST REF LVL* softkey adjusts the reference level of the ESPI to the measured channel power. This ensures that the settings of the RF attenuation and the reference level are optimally adjusted to the signal level without overloading the ESPI or limiting the dynamic range by a too small S/N ratio.

Since the measurement bandwidth for channel power measurements is significantly lower than the signal bandwidth, the signal path may be overloaded although the trace is still significantly below the reference level.

IEC/IEEE-bus command:            `SENS:POW:ACH:PRES:RLEV`

For manual setting of the test parameters different from the settings made with *ADJUST SETTINGS* the following should be observed:

Frequency span                    The frequency span must at least cover the channels to be measured plus a measurement margin of 10%.  
For channel power measurement, the span is 1.1 x channel bandwidth.

**Note:**     *If the frequency span is large in comparison with the channel bandwidth (or the adjacent-channel bandwidths) being examined, only a few points on the trace are available per channel. This reduces the accuracy of the waveform calculation for the channel filter used, which has a negative effect on the measurement accuracy.*

*We therefore strongly recommend that the formulas mentioned be taken into consideration when selecting the frequency span.*

Resolution bandwidth (RBW)

To ensure both an acceptable measurement speed and the required selection (to suppress spectral components outside the channel to be measured, especially of the adjacent channels), the resolution bandwidth must not be selected too small or too large. As a general approach, the resolution bandwidth is to be set to values between 1% and 4% of the channel bandwidth.

A larger resolution bandwidth can be selected if the spectrum within the channel to be measured and around it has a flat characteristic. In the standard setting, e.g. for standard IS95A REV at an adjacent channel bandwidth of 30 kHz, a resolution bandwidth of 30 kHz is used. This yields correct results since the spectrum in the neighborhood of the adjacent channels normally has a constant level. For standard NADC/IS136 this is not possible for example, since the spectrum of the transmit signal penetrates into the adjacent channels and a too large resolution bandwidth causes a too low selection of the channel filter. The adjacent-channel power would thus be measured too high.

With the exception of the IS95 CDMA standards, the *ADJUST SETTINGS* softkey sets the resolution bandwidth (RBW) as a function of the channel bandwidth:

$RBW \leq 1/40$  of channel bandwidth.

The maximum possible resolution bandwidth (with respect to the requirement  $RBW \leq 1/40$ ) resulting from the available RBW steps (1, 3) is selected .

Video bandwidth (VBW)

For a correct power measurement, the video signal must not be limited in bandwidth. A restricted bandwidth of the logarithmic video signal would cause signal averaging and thus result in a too low indication of the power (-2.51 dB at very low video bandwidths). The video bandwidth should therefore be selected at least three times the resolution bandwidth.

The *ADJUST SETTINGS* softkey sets the video bandwidth (VBW) as a function of the channel bandwidth as follows:

$VBW \geq 3 \times RBW$ .

The smallest possible VBW with regard to the available step size will be selected.

Detector

The *ADJUST SETTINGS* softkey selects the RMS detector.

The RMS detector is selected since it correctly indicates the power irrespective of the characteristics of the signal to be measured. In principle, the sample detector would be possible as well. Due to the limited number of trace pixels used to calculate the power in the channel, the sample detector would yield less stable results. Averaging, which is often performed to stabilize the measurement results, leads to a too low level indication and should therefore be avoided. The reduction in the displayed power depends on the number of averages and the signal characteristics in the channel to be measured.

## Setting the Channel Configuration

MEAS - CP/ACP CONFIG submenu:

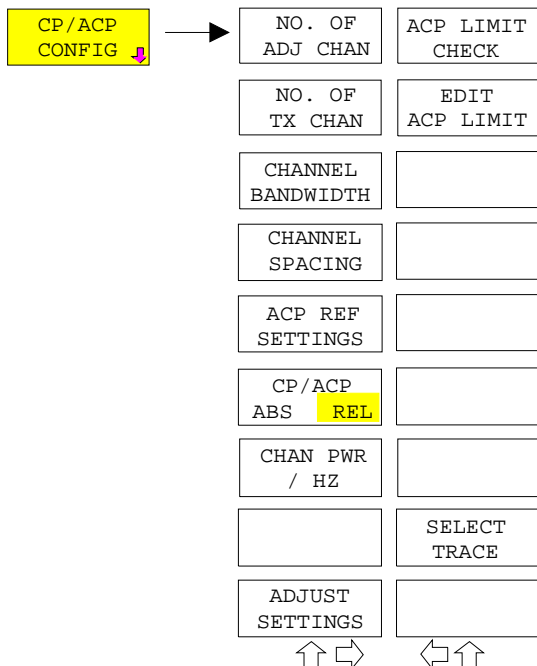

The *CP/ACP CONFIG* softkey opens a submenu for configuration of the channel power and adjacent channel power measurement independently of the offered standards.

The channel configuration includes the number of channels to be measured, the channel bandwidths (*CHANNEL BANDWIDTH*), and the channel spacings (*CHANNEL SPACING*).

Limit values can additionally be specified for the adjacent-channel power (*ACP LIMIT CHECK* and *EDIT ACP LIMITS*) which are checked for compliance during the measurement.



The *NO. OF ADJ CHAN* softkey activates the entry of the number  $\pm n$  of adjacent channels to be considered in the adjacent-channel power measurement. Numbers from 0 to 3 can be entered.

The following measurements are performed depending on the number of the channels.

- 0 Only the channel powers are measured.
- 1 The channel powers and the power of the upper and lower adjacent channel are measured.
- 2 The channel powers, the power of the upper and lower adjacent channel and of the next higher and lower channel (alternate channel 1) are measured.
- 3 The channel power, the power of the upper and lower adjacent channel, the power of the next higher and lower channel (alternate channel 1) and of the next but one higher and lower adjacent channel (alternate channel 2) are measured.

IEC/IEEE-bus command: POW:ACH:ACP 1

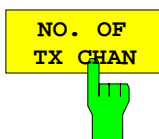

The *NO. OF TX CHAN* softkey enables the entry of the number of carrier signals to be considered in channel and adjacent-channel power measurements.

Numbers from 1 to 4 can be entered.

The softkey is available only for multicarrier ACP measurements.

IEC/IEEE-bus command: SENS:POW:ACH:TXCH:COUN 4

**CHANNEL  
BANDWIDTH**



The *CHANNEL BANDWIDTH* softkey opens a table for defining the channel bandwidths for the transmission channels and the adjacent channels.

ACP CHANNEL BW	
CHAN	BANDWIDTH
ADJ	14 kHz
ALT1	14 kHz
ALT2	14 kHz

The transmission-channel bandwidth is normally defined by the transmission standard. The correct bandwidth is set automatically for the selected standard (see *CP/ACP STANDARD* softkey).

With the IBW method (*FAST ACP OFF*), the channel bandwidth limits are marked by two vertical lines right and left of the channel center frequency. It can in this way be visually checked whether the entire power of the signal under test is within the selected channel bandwidth.

**Measurements in the time domain (*FAST ACP ON*) are performed in the zero span mode. The channel limits are indicated by vertical lines. For measurements requiring channel bandwidths deviating from those defined in the selected standard the IBW method is to be used.**

**Refer to section "Setting of Bandwidths and Sweep Time – *BW*key" for a list of available channel filters.**

When measuring according to the IBW method (*FAST ACP OFF*) the bandwidths of the different adjacent channels are to be entered numerically. Since all adjacent channels often have the same bandwidth, the other channels Alt1 and Alt2 are set to the bandwidth of the adjacent channel on entering the adjacent-channel bandwidth (ADJ). Thus only one value needs to be entered in case of equal adjacent channel bandwidths. The same holds true for the ALT2 channels (alternate channels 2) when the bandwidth of the ALT1 channel (alternate channel 1) is entered.

**Note:** *The bandwidths can be set separately by overwriting the table from top to bottom.*

IEC/IEEE-bus command: **SENS:POW:ACH:BWID:CHAN 14kHz**  
**SENS:POW:ACH:BWID:ACH 1kHz**  
**SENS:POW:ACH:BWID:ALT1 14kHz**  
**SENS:POW:ACH:BWID:ALT2 14kHz**

CHANNEL  
SPACING



The *CHANNEL SPACING* softkey opens a table for defining the channel spacings.

ACP CHANNEL SPACING	
CHAN	SPACING
ADJ	20 kHz
ALT1	40 kHz
ALT2	60 kHz

Since all the adjacent channels often have the same distance to each other, the entry of the adjacent-channel spacing (ADJ) causes channel spacing ALT1 to be set to twice and channel spacing ALT2 to three times the adjacent-channel spacing. Thus only one value needs to be entered in case of equal channel spacing. The same holds true for the ALT2 channels when the bandwidth of the ALT1 channel is entered.

**Note:** *The channel spacings can be set separately by overwriting the table from top to bottom.*

```
IEC/IEEE-bus command: SENS:POW:ACH:SPAC:CHAN 20kHz
                      SENS:POW:ACH:SPAC:ACH 20kHz
                      SENS:POW:ACH:SPAC:ALT1 40kHz
                      SENS:POW:ACH:SPAC:ALT2 60kHz
```

ACP REF  
SETTINGS



The *ACP REF SETTINGS* softkey opens a table for selecting the transmission channel to which the adjacent-channel relative power values should be referenced.

ACP REFERENCE CHANNEL	
<input checked="" type="checkbox"/>	TX CHANNEL 1
<input type="checkbox"/>	TX CHANNEL 2
<input type="checkbox"/>	TX CHANNEL 3
<input type="checkbox"/>	TX CHANNEL 4
<input type="checkbox"/>	MIN POWER TX CHANNEL
<input type="checkbox"/>	MAX POWER TX CHANNEL
<input type="checkbox"/>	LOWEST & HIGHEST CHANNEL

- TX CHANNEL 1 - 4**      Selection of one of channels 1 to 4.
- MIN POWER TX CHANNEL**      The transmission channel with the lowest power is used as a reference channel.
- MAX POWER TX CHANNEL**      The transmission channel with the highest power is used as a reference channel.
- LOWEST & HIGHEST CHANNEL**      The outer lefthand transmission channel is the reference channel for the lower adjacent channels, the outer righthand transmission channel that for the upper adjacent channels.

```
IEC/IEEE-bus command:
                      SENS:POW:ACH:REF:TXCH:MAN 1
                      SENS:POW:ACH:REF:TXCH:AUTO MIN
```



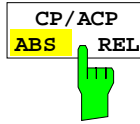

The *CP/ACP ABS/REL* softkey (channel power absolute/relative) switches between absolute and relative power measurement in the channel.

*CP/ACP ABS* The absolute power in the transmission channel and in the adjacent channels is displayed in the unit of the Y axis, e.g. in dBm, dBμV.

*CP/ACP REL* For adjacent-channel power measurements (*NO. OF ADJ CHAN* > 0), the level of the adjacent channels is displayed relative to the level of the transmission channel in dBc.

For channel power measurements (*NO. OF ADJ CHAN* = 0) **with a single carrier**, the power of the transmission channel is displayed relative to the power of a reference channel defined by *SET CP REFERENCE*. This means:

1. Declare the power of the currently measured channel as the reference value, using the *SET CP REFERENCE* softkey.
2. Select the channel of interest by varying the channel frequency (ESPI center frequency).

With linear scaling of the Y axis, the power of the new channel relative to the reference channel ( $CP/CP_{ref}$ ) is displayed. With dB scaling, the logarithmic ratio  $10\lg(CP/CP_{ref})$  is displayed.

The relative channel power measurement can thus also be used for universal adjacent-channel power measurements. Each channel can be measured individually.

IEC/IEEE-bus command: `SENS:POW:ACH:MODE ABS`

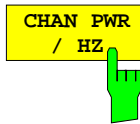

The *CHAN PWR / HZ* softkey toggles between the measurement of the total channel power and the measurement of the channel power referenced to a 1-Hz bandwidth.

The conversion factor is  $10 \cdot \lg \frac{1}{\text{Channel} \cdot \text{Bandwidth}}$ .

By means of this function it is possible e.g. to measure the signal/noise power density or use the additional functions *CP/ACP REL* and *SET CP REFERENCE* to obtain the signal to noise ratio.

IEC/IEEE-bus command:

`CALC:MARK:FUNC:POW:RES:PHZ ON|OFF`

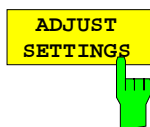

The *ADJUST SETTINGS* softkey automatically optimizes the instrument settings for the selected power measurement (see below).

All instrument settings relevant for a power measurement within a specific frequency range (channel bandwidth) are optimized for the selected channel configuration (channel bandwidth, channel spacing):

- Frequency span:

The frequency span should cover at least all channels to be considered in a measurement.

For channel power measurements, the frequency span is set as follows:

**(No. of transmission channels - 1) × transmission channel spacing + 2 × transmission channel bandwidth + measurement margin**

**For adjacent-channel power measurements, the frequency span is set as a function of the number of transmission channels, the transmission channel spacing, the adjacent-channel spacing, and the bandwidth of one of adjacent-channels ADJ, ALT1 or ALT2, whichever is furthest away from the transmission channels:**

**(No. of transmission channels - 1) × transmission channel spacing + 2 × (adjacent-channel spacing + adjacent-channel bandwidth) + measurement margin**

The measurement margin is approx. 10% of the value obtained by adding the channel spacing and the channel bandwidth.

- Resolution bandwidth     $RBW \leq 1/40$  of channel bandwidth
- Video bandwidth         $VBW \geq 3 \times RBW$
- Detector                 RMS detector

Trace math and trace averaging functions are switched off.

The reference level is not influenced by *ADJUST SETTINGS*. It can be separately adjusted with *ADJUST REF LVL*.

The adjustment is carried out only once; if necessary, the instrument settings can be changed later.

IEC/IEEE-bus command:

`SENS:POW:ACH:PRES ACP|CPOW|MCAC|OBW`

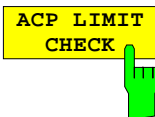

The *ACP LIMIT CHECK* softkey switches the limit check for the ACP measurement on and off.

IEC/IEEE-bus command:        `CALC:LIM:ACP ON`  
                                  `CALC:LIM:ACP:ACH:RES?`  
                                  `CALC:LIM:ACP:ALT:RES?`

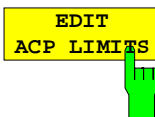

The *EDIT ACP LIMITS* softkey opens a table for defining the limits for the ACP measurement.

ACP LIMITS				
CHAN	RELATIVE LIMIT CHECK		ABSOLUTE LIMIT CHECK	
	VALUE	ON	VALUE	ON
ADJ	-45 dB	√		
ALT1	-60 dB	√		
ALT2				

The following rules apply for the limits:

- A separate limit can be defined for each adjacent channel. The limit applies to both the upper and the lower adjacent channel.
- A relative and/or absolute limit can be defined. The check of both limit values can be activated independently.
- The ESPI checks adherence to the limits irrespective of whether the limits are absolute or relative or whether the measurement is carried out with absolute or relative levels. If both limits are active and if the higher of both limit values is exceeded, the measured value is marked accordingly.

**Note:** *Measured values exceeding the limit are marked by a preceding asterisk.*

IEC/IEEE-bus command:  
                                  `CALC:LIM:ACP ON`  
                                  `CALC:LIM:ACP:ACH 0dB,0dB`  
                                  `CALC:LIM:ACP:ACH:STAT ON`  
                                  `CALC:LIM:ACP:ACH:ABS -10dBm,-10dBm`  
                                  `CALC:LIM:ACP:ACH:ABS:STAT ON`  
                                  `CALC:LIM:ACP:ALT1 0dB,0dB`  
                                  `CALC:LIM:ACP:ALT1:STAT ON`  
                                  `CALC:LIM:ACP:ALT1:ABS -10dBm,-10dBm`  
                                  `CALC:LIM:ACP:ALT1:ABS:STAT ON`  
                                  `CALC:LIM:ACP:ALT2 0dB,0dB`  
                                  `CALC:LIM:ACP:ALT2:STAT ON`  
                                  `CALC:LIM:ACP:ALT2:ABS -10dBm,-10dBm`  
                                  `CALC:LIM:ACP:ALT2:ABS:STAT ON`

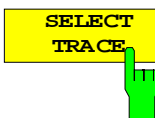

The *SELECT TRACE* softkey selects the trace on which the CP/ACP measurement is to be performed. Only activated traces can be selected, i.e. traces not set to BLANK.

IEC/IEEE-bus command:        `SENS:POW:TRAC 1`

## Examples:

### 1. Measurement of adjacent-channel power for a specific standard:

The adjacent-channel power is to be measured for a signal at 800 MHz with 0 dBm level in line with IS136.

[PRESET]	Set the ESPI to the default setting.
[FREQ: CENTER: 800 MHz]	Set the center frequency to 800 MHz.
[AMPT: 0 dBm]	Set the reference level to 0 dBm.
[MEAS]	Call the menu for the measurement functions.
[CHAN PWR / ACP]	Select the channel and adjacent-channel power measurement function. The measurement is performed with the default settings or a previously defined setting. The submenu for setting the desired new configuration is opened.
[CP/ACP STANDARD: select IS136: ENTER]	Select the NADC (IS136) standard.
[CP/ACP CONFIG]	Call the submenu for configuration of the adjacent-channel power measurement.
[NO. OF ADJ CHAN: 2 ENTER]	Select two adjacent channels for the measurement, i.e. the adjacent channel and the alternate channel are measured.
[ADJUST SETTINGS]	Set the optimum span, resolution bandwidth (RBW), video bandwidth (VBW) and detector automatically for the measurement. The absolute channel power and the relative power of the adjacent channels are displayed on the screen.
	Change to the main menu for channel power measurement.
[ADJUST REF LVL]	Set the reference level equal to the channel power measured.

### 2. Measurement with user-specific channel configuration:

Measurement of the adjacent-channel power ratio (ACPR) of an IS95 CDMA signal at 800 MHz, level 0 dBm. Similar to example 1, the setting can be simplified by using *CP/ACP STANDARD*.

[PRESET]	Set the ESPI to the default setting.
[FREQ: CENTER: 800 MHz]	Set the center frequency to 800 MHz.
[AMPT: 0 dBm]	Set the reference level to 0 dBm.
[MEAS]	Call the menu for the measurement functions.
[CHAN PWR / ACP]	Select the channel and adjacent-channel power measurement function. The measurement is carried out with the default settings or a previously defined setting. The submenu for setting the desired new configuration is opened.
[CP/ACP CONFIG]	Call the submenu for defining the channel configuration.
[NO. OF ADJ CHAN: 2 ENTER]	Select two adjacent channels for the measurement, i.e. the adjacent channel and the alternate channel are measured.

[CHANNEL BANDWIDTH:

1.23 MHz: : 30 kHz]

Set the channel bandwidth to 1.23 MHz in accordance with IS 95.  
Set the adjacent-channel bandwidth to 30 kHz.

TX/ACP CHANNEL BW	
CHAN	BANDWIDTH
TX	1.23 MHz
ADJ	30 kHz
ALT1	30 kHz
ALT2	30 kHz

Upon entry of 30 kHz for the adjacent channel the alternate channels are also set to 30 kHz.

[CHAN SPACING:

1.25 MHz: 

885 kHz: 

-1.98 MHz]   
2.97 MHz]

Open the list for entering the channel spacings.

TX/ACP CHAN SPACING	
CHAN	SPACING
TX	1.25 MHz
ADJ	885 kHz
ALT1	1.98 MHz
ALT2	2.97 MHz

Upon entry of 885 kHz for the adjacent channel the channels ALT1 and ALT2 are set to 1770 kHz and 2655 kHz. Upon entry of 1.98 MHz for the alternate channel 1 the alternate channel 2 is set to 2.97 MHz.

[ADJUST SETTINGS]

Automatically set the optimum span (= 5 MHz), resolution bandwidth (RBW = 30 kHz), video bandwidth (VBW = 300 kHz) and detector (RMS) for the measurement. The absolute channel power and the relative power of the adjacent channels and alternate channels are displayed on the screen.



Go to the main menu for channel power measurement.

[ADJUST REF LVL]

Set the reference level equal to the channel power measured.

### 3. Measurement of signal/noise power density (C/No) of an IS95 CDMA signal (frequency 800 MHz, level 0 dBm)

[PRESET]

Set the ESPI to the default setting.

[FREQ: CENTER: 800 MHz]

Set the center frequency to 800 MHz.

[AMPT: 0 dBm]

Set the reference level to 0 dBm.

[MEAS]

Call the menu for the measurement functions.

[CHAN PWR / ACP]

Select the channel and adjacent-channel power measurement. The measurement is performed with the default setting or a previously defined setting. The submenu for setting the desired new configuration is opened.

[CP/ACP CONFIG]

Call the submenu for defining the channel configuration.

[NO. OF ADJ CHAN:  
0 ENTER]

Do not select an adjacent channel for the measurement, i.e. the measurement is carried out in one channel only.

[CHANNEL BANDWIDTH:  
1.23 MHz]

Set the channel bandwidth to 1.23 MHz in line with IS95.

[ADJUST SETTINGS]

Set the optimum span (= 5 MHz), resolution bandwidth (RBW = 30 kHz), video bandwidth (VBW = 300 kHz) and detector (RMS) for the measurement automatically. The absolute channel power and the relative power of the adjacent channels and alternate channels are displayed on the screen.

PREV

Go to the main menu for channel power measurement

[ADJUST REF LVL]

Set the reference level equal to the channel power measured.

[SET CP REFERENCE]

Set the measured channel power as a reference for the subsequent measurements.

[CP/ACP ABS / REL]

Select relative measurement related to the reference power set with SET REFERENCE (result 0 dB).

[CHAN PWR / HZ]

Select power measurement related to 1 Hz bandwidth (result -60.9 dB).

[FREQ: CENTER: 805 MHz]

Set the center frequency to 805 MHz. The ESPI measures the channel power at 1.23 MHz bandwidth and outputs the result in dB relative to the reference power and 1 Hz bandwidth.

## Additional softkeys for menu FILE

For easier operation, the *FILE* menu was extended by softkeys *ASCII FILE EXPORT* and *DECIMAL SEP* in the *FILE - NEXT* submenu . The softkeys are also available in the *TRACE* menu.

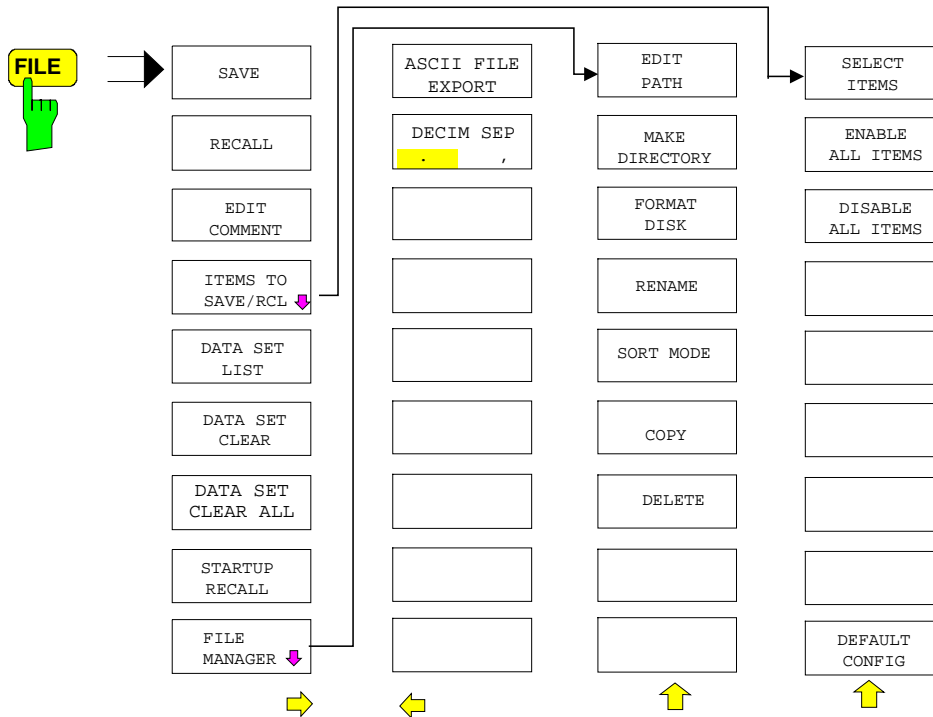

*FILE - NEXT* menu:



The *ASCII FILE EXPORT* softkey stores the active trace in ASCII format to a diskette.

IEC/IEEE-bus command:       FORM ASC;  
                                  MMEM:STOR:TRAC 1, 'TRACE.DAT'

The file consists of a header, which contains important scaling parameters, and a data section, which contains the trace data.

The file header data comes in three columns separated by semicolons (;). It has the following contents:

parameter name; numerical value; default unit

The data section starts with the keyword "Trace <n>", where <n> designates the number of the trace to be stored. This is followed by the measured data in columns separated by semicolons (;).

This format can be read by spreadsheet programs such as MS Excel. A semicolon (;) is to be defined as a separator between the cells of a table.

**Note:**       *Analysis programs may come in different language versions that require different notations of the decimal point. By means of the DECIM SEP softkey, a decimal point (.) or a comma (,) can be selected as decimal-point notation.*

For a detailed description of the ASCII file format refer to section "Selection and Setting of Traces – TRACE Key", *ASCII FILE EXPORT* softkey.

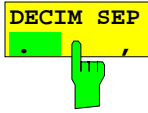

By means of the *DECIM SEP* softkey, one can select between a decimal point (.) and a comma (,) as decimal-point notation for the ASCII FILE EXPORT function.

Due to the possibility of selecting between different decimal-point notations, different language versions of analysis programs (such as MS Excel) can be supported.

IEC/IEEE-bus command:           FORM:DEXP:DSEP POIN

### **Trigger line remains on screen after leaving the TRIG menu**

The line indicating the trigger level for active video trigger is preserved on the screen even if the trigger menu is abandoned.



## New and Modified Remote Control Commands

### CALCulate<1|2>:LIMit<1 ... 8>:CONTrol:SPACing LINear | LOGarithmic

This command selects linear or logarithmic interpolation for the calculation of limit lines from frequency points.

**Example:** "CALC:LIM:CONT:SPAC LIN"

**Characteristics:** \*RST value: LIN  
SCPI: device-specific

**Mode:** A

### CALCulate<1|2>:LIMit<1 to 8>:LOWer:SPACing LINear | LOGarithmic

This command selects linear or logarithmic interpolation for the lower limit line.

**Example:** "CALC:LIM:LOW:SPAC LIN"

**Characteristics:** \*RST value: LIN  
SCPI: device-specific

**Mode:** A

### CALCulate<1|2>:LIMit<1 to 8>:UPPer:SPACing LINear | LOGarithmic

This command selects linear or logarithmic interpolation for the upper limit line.

**Example:** "CALC:LIM:UPP:SPAC LIN"

**Characteristics:** \*RST value: LIN  
SCPI: device-specific

**Mode:** A

### CALCulate<1|2>:MARKer<1...4>:FUNCtion:POWer:SElect ACPower | CPOWer | MCACpower | OBANdwidth | OBWidth | CN | CN0

This command selects – and switches on – one of the above types of power measurement in the selected measurement window. This function is independent of the selected marker, i.e. the numerical suffix <1...4> appended to MARKer has no effect.

The channel spacings and channel bandwidths are configured in the SENSE:POWer:ACHannel subsystem.

Please note the following:

If CPOWer is selected, the number of adjacent channels (command: [SENSE:]POWer:ACHannel:ACPairs) is set to 0. If ACPower is selected, the number of adjacent channels is set to 1, unless adjacent-channel power measurement is switched on already.

With respect to the above two settings, the behaviour of the ESPI differs from that of the ESIB family.

**Note:** *The channel/adjacent-channel power measurement is performed for the trace selected with SENSE:POWer:TRACe 1|2|3.*

*The occupied bandwidth measurement is performed for the trace on which marker 1 is positioned. To select another trace for the measurement, marker 1 is to be positioned on the desired trace by means of CALC:MARK:TRAC 1|2|3.*

<b>Parameters:</b> ACPower	Adjacent-channel power measurement with a single carrier signal
CPOWer	Channel power measurement with a single carrier signal (equivalent to adjacent-channel power measurement with <i>NO. OF ADJ CHAN = 0</i> )
MCACpower	Channel/adjacent-channel power measurement with several carrier signals
OBANdwidth   OBWidth	Measurement of occupied bandwidth
CN	Measurement of carrier-to-noise ratio
CN0	Measurement of carrier-to-noise ratio referenced to 1 Hz bandwidth

**Example:** "CALC:MARK:FUNC:POW:SEL ACP" 'Switches on adjacent-channel power measurement in window A.

**Characteristics:** \*RST value: -  
SCPI: device-specific

**Mode:** A-F

**CALCulate<1|2>:MARKer<1...4>:FUNctioN:POWer:RESult?** ACPower | CPOWer | MCACpower | OBANdwidth | OBWidth | CN | CN0

This command queries the result of the power measurement performed in the selected window. If necessary, the measurement is switched on prior to the query.

The channel spacings and channel bandwidths are configured in the `SENSe:POWer:ACHannel` subsystem.

To obtain a valid result, a complete sweep with synchronization to the end of the sweep must be performed before a query is output. Synchronization is possible only in the single-sweep mode.

**Parameters:**

**ACPower:** Adjacent-channel power measurement  
Results are output in the following sequence, separated by commas:  
Power of transmission channel  
Power of lower adjacent channel  
Power of upper adjacent channel  
Power of lower alternate channel 1  
Power of upper alternate channel 1  
Power of lower alternate channel 2  
Power of upper alternate channel 2

The number of measured values returned depends on the number of adjacent/alternate channels selected with `SENSe:POWer:ACHannel:ACPairs`.

With logarithmic scaling (`RANGE LOG`), the power is output in the currently selected level unit; with linear scaling (`RANGE LIN dB` or `LIN %`), the power is output in W. If `SENSe:POWer:ACHannel:MODE REL` is selected, the adjacent/alternate-channel power is output in dB.

<b>CPOWer</b>	<p>Channel power measurement</p> <p>With logarithmic scaling (RANGE LOG), the channel power is output in the currently selected level unit; with linear scaling (RANGE LIN dB or LIN %), the channel power is output in W.</p>
<b>MCACpower:</b>	<p>Channel/adjacent-channel power measurement with several carrier signals</p> <p>Results are output in the following sequence, separated by commas:</p> <ol style="list-style-type: none"> <li>1. Power of carrier signal 1</li> <li>2. Power of carrier signal 2</li> <li>3. Power of carrier signal 3</li> <li>4. Power of carrier signal 4</li> <li>5. Total power of all carrier signals</li> <li>6. Power of lower adjacent channel</li> <li>7. Power of upper adjacent channel</li> <li>8. Power of lower alternate channel 1</li> <li>9. Power of upper alternate channel 1</li> <li>10. Power of lower alternate channel 2</li> <li>11. Power of upper alternate channel 2</li> </ol> <p>The number of measured values returned depends on the number of carrier signals and adjacent/alternate channels selected with <code>SENSe:POWer:ACHannel:TXChannel:COUNT</code> and <code>SENSe:POWer:ACHannel:ACPairs</code>.</p> <p>If only one carrier signal is measured, the total value of all carrier signals will not be output.</p> <p>With logarithmic scaling (RANGE LOG), the power is output in dBm; with linear scaling (RANGE LIN dB or LIN %), the power is output in W. If <code>SENSe:POWer:ACHannel:MODE REL</code> is selected, the adjacent/alternate-channel power is output in dB.</p>
<b>OBANdwidth OBWidth</b>	<p> Measurement of occupied bandwidth</p> <p>The occupied bandwidth in Hz is returned.</p>
<b>CN</b>	<p>Measurement of carrier-to-noise ratio</p> <p>The carrier-to-noise ratio in dB is returned.</p>
<b>CNO</b>	<p>Measurement of carrier-to-noise ratio referenced to 1 Hz bandwidth.</p> <p>The carrier-to-noise ratio in dB/Hz is returned.</p>

### Example of channel/adjacent-channel power measurement:

"SENS2:POW:ACH:ACP 3"	'Sets the number of adjacent/alternate channels in screen B to 3.
"SENS2:POW:ACH:BAND 30KHZ"	'Sets the bandwidth of the transmission channel to 30 kHz.
"SENS2:POW:ACH:BAND:ACH 40KHZ"	'Sets the bandwidth of each adjacent channel to 40 kHz.
"SENS2:POW:ACH:BAND:ALT1 50KHZ"	'Sets the bandwidth of each alternate channel to 50 kHz.
"SENS2:POW:ACH:BAND:ALT2 60KHZ"	'Sets the bandwidth of alternate channel 2 to 60 kHz.
"SENS2:POW:ACH:SPAC 30KHZ"	'Sets the spacing between the transmission channel and the adjacent channel to 30 kHz, the spacing between the transmission channel and alternate channel 1 to 60 kHz, and the spacing between the transmission channel and alternate channel 2 to 90 kHz.
"SENS2:POW:ACH:SPAC:ALT1 100KHZ"	'Sets the spacing between the transmission channel and alternate channel 1 to 100 kHz, and the spacing between the transmission channel and alternate channel 2 to 150 kHz.
"SENS2:POW:ACH:SPAC:ALT2 140KHZ"	'Sets the spacing between the transmission channel and alternate channel 2 to 140 kHz.
"SENS2:POW:ACH:MODE ABS"	'Switches on absolute power measurement.
"CALC2:MARK:FUNC:POW:SEL ACP"	'Switches on the adjacent-channel power measurement in screen B.
"INIT:CONT OFF"	'Switches over to single-sweep mode.
"INIT;*WAI"	'Starts a sweep and waits for the end of the sweep.
"CALC2:MARK:FUNC:POW:RES? ACP"	'Queries the result of adjacent-channel power measurement in screen B.
"SENS2:POW:ACH:REF:AUTO ONCE"	'Defines the measured channel power as the reference value for relative power measurements.

If the **channel power only** is to be measured, all commands relating to adjacent/alternate channel bandwidth and channel spacings are omitted. The number of adjacent/alternate channels is set to 0 with `SENS2:POW:ACH:ACP 0`.

### Example of occupied bandwidth measurement:

"SENS2:POW:BAND 90PCT"	'Defines 90% as the percentage of the power to be contained in the bandwidth range to be measured.
"INIT:CONT OFF"	'Switches over to single-sweep mode.
"INIT;*WAI"	'Starts a sweep and waits for the end of the sweep.
"CALC2:MARK:FUNC:POW:RES? OBW"	'Queries the occupied bandwidth measured in screen B.

**Characteristics:** \*RST value: -  
SCPI: device-specific

**Mode:** A-F

This command is a query and therefore has no \*RST value.

**DISPlay[:WINDow<1|2>]:SIZE LARGE | SMALL**

This command switches the measurement window for channel and adjacent-channel power measurements to full screen or half screen. Only "1" is allowed as a numerical suffix.

**Example:** "DISP:WIND1:SIZE LARG" 'Switches the measurement window to full screen.

**Characteristics:** \*RST value: SMALL  
SCPI: device-specific

**Mode:** A, 3G FDD

**DISPlay[:WINDow<1|2>]:TRACe<1...3>:Y:SPACing LINear | LOGarithmic | LDB**

This command defines linear or logarithmic scaling for the selected measurement window. For linear scaling, the unit % (command DISP:WIND:TRAC:Y:SPAC LIN) or dB (command DISP:WIND:TRAC:Y:SPAC LDB) can be selected.

The numerical suffix <1...3> appended to TRACe has no effect.

**Example:** "DISP:WIND1:TRAC:Y:SPAC LIN"

**Characteristics:** \*RST value: LOGarithmic  
SCPI: conforming

**Mode:** A

**:[SENSe<1|2>]:CORRection:YIG:TEMPerature:AUTO ON | OFF**

This command switches on or off the automatic correction of the YIG filter frequency drift.

When correction is switched on, it is checked once per minute whether the temperature on the YIG filter has changed by more than 5K relative to the last instance of correction. If this is the case, the frequency of the YIG filter is – at the end of the next measurement – adjusted as required for the new temperature. For time-critical applications, the correction function can be switched off after an operating period of  $\geq 30$  minutes.

**Example:** "CORR:YIG:TEMP OFF" 'Switches off automatic correction of the YIG filter frequency drift.

**Characteristics:** \*RST value: ON  
SCPI: device-specific

**Mode:** all

This command is available only from firmware version 1.72.

The ON parameter is available only if the MW CONV UNIT module has one of the following modification states:

Order No.	Rev	SubRev
1130.2396	$\geq 02$	$\geq 01$
1130.2544	$\geq 02$	$\geq 01$

**SENSe:LIST Subsystem**

The commands of this subsystem are used for measuring the power at a list of frequency points with different device settings. The measurement is always performed in the time domain (span = 0 Hz).

The number of frequencies is now extended to 200 entries.

**[SENSe<1|2>:]POWer:ACHannel:SPACing:CHANnel 100 Hz to 2000 MHz**

This command defines the channel spacing for the carrier signals.

The command is available only for measurements in the frequency domain (span > 0).

**Example:** "POW:ACH:SPAC:CHAN 25kHz"

**Characteristics:** \*RST value: 20 kHz  
SCPI: device-specific

**Mode:** A-F

**[SENSe<1|2>:]POWer:ACHannel:TXCHannel:COUNt 1 | 2 | 3 | 4**

This command selects the number of carrier signals.

The command is available only for multicarrier channel and adjacent-channel power measurements (CALC:MARK:FUNC:POW:SEL MCAC) in the frequency domain (span > 0).

**Example:** "POW:ACH:TXCH:COUN 3"

**Characteristics:** \*RST value: 4  
SCPI: device-specific

**Mode:** A-F

**[SENSe<1|2>:]POWer:ACHannel:REFerence:TXCHannel:AUTO MINimum | MAXimum | LHIGHest**

This command activates the automatic selection of a transmission channel to be used as a reference channel in relative adjacent-channel power measurements.

The transmission channel with the highest power, the transmission channel with the lowest power, or the transmission channel nearest to the adjacent channels can be defined as a reference channel.

The command is available only for multicarrier channel and adjacent-channel power measurements (CALC:MARK:FUNC:POW:SEL MCAC) in the frequency domain (span > 0).

**Parameters:** MINimum Transmission channel with the lowest power  
MAXimum Transmission channel with the highest power  
LHIGHest Lowermost transmission channel for the lower adjacent channels,  
uppermost transmission channel for the upper adjacent channels

**Example:** "POW:ACH:REF:TXCH:AUTO MAX" 'The transmission channel with the highest power is used as a reference channel.

**Characteristics:** \*RST value: -  
SCPI: device-specific

**Mode:** A-F

**[SENSe<1|2>:]POWer:ACHannel:REFerence:TXCHannel:MANual 1 | 2 | 3 | 4**

This command selects a transmission channel to be used as a reference channel in relative adjacent-channel power measurements.

The command is available only for multicarrier channel and adjacent-channel power measurements (CALC:MARK:FUNC:POW:SEL MCAC) in the frequency domain (span > 0).

**Example:** "POW:ACH:REF:TXCH:MAN 3" 'Transmission channel 3 is used as a reference channel.

**Characteristics:** \*RST value: 1  
SCPI: device-specific

**Mode:** A-F

**[SENSe<1|2>:]POWer:ACHannel:PRESet** ACPower | CPOWer | MCACpower | OBANdwidth | OBWidth | CN | CN0

This command adjusts the frequency span, the measurement bandwidths and the detector as required for the number of channels, the channel bandwidths and the channel spacings selected in the active power measurement. If necessary, adjacent-channel power measurement is switched on prior to the adjustment.

To obtain valid results, a complete sweep with synchronization to the end of the sweep must be performed after the adjustment. Synchronization is possible only in the single-sweep mode.

The result is queried with the command `CALCulate:MARKer:FUNction:POWer:RESult?`.

The command is available only for measurements in the frequency domain (span > 0).

**Example:**

<code>"POW:ACH:PRESet ACP"</code>	'Sets the frequency span, the measurement bandwidths and the detector as required for the ACP measurement in screen A.
<code>"INIT:CONT OFF"</code>	'Switches over to single-sweep mode.
<code>"INIT;*WAI"</code>	'Starts a sweep and waits for the end of the sweep.
<code>"CALC:MARK:FUNC:POW:RES? ACP"</code>	'Queries the result of the adjacent-channel power measurement.

**Characteristics:** \*RST value: -  
SCPI: device-specific

**Mode:** A-F

**[SENSe<1|2>:]SWEep:POINts <numeric\_value>**

This command defines the number of measurement points for one sweep run.

**Parameter:** <numeric\_value> ::= 125, 251, 501, 1001, 2001, 4001, 8001

**Example:** `"SWE:POIN 251"`

**Characteristics:** \*RST value: 501  
SCPI: conforming

**Modes:** A

**:TRACe:FEED:CONTRol<1 to 4>** ALWays | NEVer

This command switches block data transmission during a scan on and off.

**Example:** `"TRAC:FEED:CONTR ALW"`

**Features:** \*RST Value: NEVer  
SCPI: conforming

**Mode:** R

The block size depends on the scan time, the trace number is not evaluated.

# Certified Quality System ISO 9001

**DQS REG. NO 1954-04**

## Qualitätszertifikat

Sehr geehrter Kunde,

Sie haben sich für den Kauf eines Rohde & Schwarz-Produktes entschieden. Hiermit erhalten Sie ein nach modernsten Fertigungsmethoden hergestelltes Produkt. Es wurde nach den Regeln unseres Qualitätsmanagementsystems entwickelt, gefertigt und geprüft. Das Rohde & Schwarz-Qualitätsmanagementsystem ist nach ISO 9001 zertifiziert.

## Certificate of quality

Dear Customer,

You have decided to buy a Rohde & Schwarz product. You are thus assured of receiving a product that is manufactured using the most modern methods available. This product was developed, manufactured and tested in compliance with our quality management system standards.

The Rohde & Schwarz quality management system is certified according to ISO 9001.

## Certificat de qualité

Cher client,

Vous avez choisi d'acheter un produit Rohde & Schwarz. Vous disposez donc d'un produit fabriqué d'après les méthodes les plus avancées. Le développement, la fabrication et les tests respectent nos normes de gestion qualité. Le système de gestion qualité de Rohde & Schwarz a été homologué conformément à la norme ISO 9001.



**ROHDE & SCHWARZ**







Certificate No.: 2001-06

This is to certify that:

Equipment type	Stock No.	Designation
ESPI3	1142.8007.03	EMI Test Receiver
ESPI7	1142.8007.07	
ESPI-B2	1129.7498.02	Option: Preselector

complies with the provisions of the Directive of the Council of the European Union on the approximation of the laws of the Member States

- relating to electrical equipment for use within defined voltage limits  
(73/23/EEC revised by 93/68/EEC)
- relating to electromagnetic compatibility  
(89/336/EEC revised by 91/263/EEC, 92/31/EEC, 93/68/EEC)

Conformity is proven by compliance with the following standards:

EN61010-1 : 1993 + A2 : 1995  
EN55011 : 1998 + A1 : 1999  
EN61326-1 : 1997 + A1 : 1998

For the assessment of electromagnetic compatibility, instrument class B as well as immunity to interference for operation in industry have been used as a basis.

Affixing the EC conformity mark as from 2001

**ROHDE & SCHWARZ GmbH & Co. KG**  
**Mühdorfstr. 15, D-81671 München**

Munich, 2001-02-02

Central Quality Management FS-QZ / Becker



---

# Support Center

**Telefon / Telephone:** (0180) 512 42 42

**Fax:** (++)89) 41 29 - 137 77

**e-mail:** [CustomerSupport@rsd.rohde-schwarz.com](mailto:CustomerSupport@rsd.rohde-schwarz.com)

---

Für technische Fragen zu diesem Rohde & Schwarz-Gerät steht Ihnen ab sofort unsere Hotline der Rohde & Schwarz Vertriebs-GmbH, Support Center, zur Verfügung.

Unser Team bespricht mit Ihnen Ihre Fragen und sucht Lösungen für Ihre Probleme.

Die Hotline ist Montag bis Freitag von 8.00 bis 17.00 Uhr besetzt.

Bei Anfragen außerhalb der Geschäftszeiten hinterlassen Sie bitte eine Nachricht oder senden Sie eine Notiz per Fax oder e-mail. Wir setzen uns dann baldmöglichst mit Ihnen in Verbindung.

Should you have any technical questions concerning this Rohde & Schwarz product, please contact the hotline of Rohde & Schwarz Vertriebs-GmbH, Support Center.

Our hotline team will answer your questions and find solutions to your problems.

You can reach the hotline Monday through Friday from 8:00 until 17:00.

If you need assistance outside office hours, please leave a message or send us a fax or e-mail. We will contact you as soon as possible.



**ROHDE & SCHWARZ**



**HEADQUARTERS**

	Phone	Zweigniederlassung Nürnberg	0911 64203-0
	Fax	Donaustraße 36	0911 64203-33
	E-mail	90451 Nürnberg	-
Rohde & Schwarz GmbH & Co. KG	+49 89 4129-0	Zweigniederlassung Telekommunikation +	06102 2007-0
Mühlhofstraße 15 · 81671 München	+49 89 4129-12164	Mitte	06102 2007-12
Postfach 801469 · 81614 München	-	Siemensstraße 20	-
		63263 Neu-Isenburg	

**PLANTS**

Rohde & Schwarz Messgerätebau GmbH	+49 83 31 1 08-0
Riedbachstraße 58 · 87700 Memmingen	+49 83 31 1 08-1 24
Postfach 1652 · 87686 Memmingen	-
Rohde & Schwarz GmbH & Co. KG	+49 99 23 8 50-0
Werk Teisnach	+49 99 23 8 50-1 74
Kaikenrieder Straße 27 · 94244 Teisnach	-
Postfach 1149 · 94240 Teisnach	-
Rohde & Schwarz GmbH & Co. KG	+49 22 03 49-0
Werk Köln	+49 22 03 49-3 08
Graf-Zeppelin-Straße 18 · 51147 Köln	-
Postfach 98 02 60 · 51130 Köln	-

**SUBSIDIARIES**

Rohde & Schwarz Vertriebs-GmbH	+49 89 4129-12007
Mühlhofstraße 15 · 81671 München	+49 89 4129-13567
Postfach 80 14 69 · 81614 München	-
Rohde & Schwarz International GmbH	+49 89 4129-12005
Mühlhofstraße 15 · 81671 München	+49 89 4129-3597
Postfach 80 14 60 · 81614 München	-
Rohde & Schwarz Engineering and Sales GmbH	+49 89 4129-13711
Mühlhofstraße 15 · 81671 München	+49 89 4129-13723
Postfach 80 14 29 · 81614 München	-
R&S BICK Mobilfunk GmbH	+49 50 42 9 98-0
Im Landerfeld 7 · 31848 Bad Münder	+49 50 42 9 98-105
Postfach 2062 · 31844 Bad Münder	-

Rohde & Schwarz FTK GmbH	+49 30 6 58 91-0
Wendenschloßstraße 168, Haus 28	+49 30 65 55 02 21
12557 Berlin	-
Rohde & Schwarz SIT GmbH	+49 30 6 58 84-222
Wendenschloßstraße 168, Haus 28	+49 30 6 58 84-183
12557 Berlin	-

**ADDRESSES GERMANY**

Rohde & Schwarz Vertriebs-GmbH	+49 89 4129-2007
Mühlhofstraße 15 · 81671 München	+4989 4129-3567
Postfach 80 14 69 · 81614 München	-

Zweigniederlassungen der Rohde & Schwarz Vertriebs-GmbH/Branch offices of Rohde & Schwarz Vertriebs-GmbH

Zweigniederlassung Berlin	030 34 79 48-0
Ernst-Reuter-Platz 10 · 10587 Berlin	030 3479 48-48
Postfach 100620 · 10566 Berlin	-

Zweigniederlassung Bonn	0228 918 90-0
Josef-Wirmer-Straße 1-3 · 53123 Bonn	0228 25 50 87
Postfach 140264 · 53057 Bonn	-

Zweigniederlassung Hamburg	040 63 29 00-0
Steilshooper Alle 47 · 22309 Hamburg	040 630 78 70
Postfach 60 22 40 · 22232 Hamburg	-

Zweigniederlassung Köln	02203 807-0
Graf-Zeppelin-Straße 18 · 51147 Köln	02203 807-50
Postfach 900 149 · 51111 Köln	-

Zweigniederlassung München	089 41 86 95-0
Mühlhofstraße 15 · 81671 München	089 4047 64
Postfach 80 14 69 · 81614 München	-

**ADDRESSES WORLDWIDE**

<b>Algeria</b>	ROHDE & SCHWARZ Bureau d'Alger 58 Place de Laperrine 16035 Hydra-Alger	+213 (21) 48 20 18 +213 (21) 69 46 08
----------------	---	--

<b>Argentina</b>	PRECISION ELECTRONICA S.R.L. Av. Julio A. Roca 710 - Piso 6 1067 Buenos Aires	+54 (14) 331 16 85 +54 (14) 334 51 11 alberto_lombardi@prec- elec.com.ar
------------------	---	---

<b>Australia</b>	ROHDE & SCHWARZ (AUSTRALIA) Pty. Ltd. Sales Support Unit 6 2-8 South Street Rydalmere, N.S.W. 2116	+61 (2) 88 45 41 00 +61 (2) 96 38 39 88 sales@rsaus.rohde- schwarz.com
------------------	--	---

<b>Austria</b>	ROHDE & SCHWARZ-ÖSTERREICH Ges.m.b.H. Sonnleithnergasse 20 1100 Wien	+43 (1) 602 61 41-0 +43 (1) 602 61 41-14 office@rsoe.rohde- schwarz.com
----------------	---	--

<b>Azerbaijan</b>	ROHDE & SCHWARZ Azerbaijan Liaison Office Baku Azerbaijan Avenue 35 370000 Baku	+994 (12) 93 31 38 u. +994 (12) 98 79 01 +994 (12) 93 03 14 r&s-azerbaijan@artel.net.az
-------------------	--	--

<b>Baltic Countries</b>	siehe/see Denmark	
-------------------------	-------------------	--

<b>Bangladesh</b>	BIL Consortium Ltd. Corporation Office House No: 95/A, Block - 'F' Road No: 4, Banani Dhaka-1213	+880 (2) 881 06 53 +880 (2) 882 82 91
-------------------	--	--

<b>Belgium</b>	ROHDE & SCHWARZ BELGIUM N.V. Excelsiorlaan 31 Bus 1 1930 Zaventem	+32 (2) 721 50 02 +32 (2) 725 09 36 info@rsb.rohde- schwarz.com
----------------	---	--

<b>Bolivia</b>	RIBCO LTDA. Av. Mariscal Santa Cruz # 1392 Ed. Cámara Nacional de Comercio Piso 10, Of. 1010-1011 La Paz	+591 (2) 33 48 05 +591 (2) 39 30 47 gibatta@caoba.entelnet.bo
----------------	--	---

<b>Brasilia</b>	ROHDE & SCHWARZ DO BRASIL LTDA. Av. Alfredo Egidio de Souza Aranha, 177, 1. Andar - Santo Amaro 04726-170 Sao Paulo - SP	+55 (11) 56 41 12 00 +55 (11) 56 41 78 10 andrea.silva@rsdb.rohde- schwarz.com
-----------------	---	---

<b>Brunei</b>	GKL- Equipment PTE. Ltd. #11-01 BP Tower 396, Alexandra Road Singapore 119954	+65 (2) 76 06 26 +65 (2) 76 06 29 gkleqpt@signet.com.sg
---------------	--	---

<b>Bulgaria</b>	siehe / see Austria	
-----------------	---------------------	--

<b>Canada</b>	ROHDE & SCHWARZ CANADA Inc. 555 March Rd. Kanata, Ontario K2K 2M5	+1 (613) 592 80 00 +1 (613) 592 80 09 cgirwarnauth@rscanada.ca
---------------	---	--

<b>Canada</b>	TEKTRONIX CANADA Inc. Test and Measurement 3280 Langstaff Road, Unit 1 Concord, Ontario L4K 5B6	+1 (416) 747 50 00
---------------	--	--------------------

<b>Chile</b>	DYMEQ Ltda. Av. Larrain 6666 Santiago	+56 (2) 277 50 50 +56 (2) 227 87 75	<b>Greece</b>	MERCURY S.A. 6, Loukianou Str. 10675 Athens	+30 (1) 722 92 13 +30 (1) 721 51 98 mercury@hol.gr
<b>China</b>	ROHDE & SCHWARZ Representative Office Beijing Room 602, Parkview Center 2 Jiangtai Road Chaoyang District Beijing 100016	+86 (10) 64 31 28 28 +86 (10) 64 37 98 88 info.rschina@rsbp.rohde- schwarz.com	<b>Guatemala</b>	siehe / see Mexico (EPSA)	
<b>Colombia</b>	FERROSTAAL DE COLOMBIA LTDA. Av. El Dorado No. 97-03 Bogotá, D.C.	+57 (1) 401 13 00 +57 (1) 413 18 06 miguel_canon@ferrostaal.c om	<b>Honduras</b>	siehe / see Mexico (EPSA)	
<b>Croatia</b>	siehe / see Austria		<b>Hongkong</b>	Schmidt Co. (H.K.) Ltd., 36/F Dorset House, Taikoo Place 979 King's Road Quarry Bay Hong Kong	+852 (25) 07 03 33 +852 (25) 07 09 25 kevinpoon@shk.schmidtgroup.com
<b>Czech Republic</b>	ROHDE & SCHWARZ - Praha s.r.o. Evropská 33c 16000 Praha 6	+420 (2) 24 32 20 14 +420 (2) 24 31 70 43 rohdecz@rsoe.com	<b>Hungary</b>	ROHDE & SCHWARZ Budapesti Iroda Etele ut. 68 1115 Budapest	+36 (1) 203 02 82 +36 (1) 203 02 82 rohdehu@rsoe.rohde-schwarz.com
<b>Denmark</b>	ROHDE & SCHWARZ DANMARK A/S Ejby Industrivej 40 2600 Glostrup	+45 (43) 43 66 99 +45 (43) 43 77 44	<b>Iceland</b>	siehe / see Denmark	
<b>Ecuador</b>	REPRESENTACIONES MANFRED WEINZIERL Guanguiltagua 72 ( 39-93) Urbanización Jardines del Batán Quito	+593 (2) 25 22 51 +593 (2) 25 22 51 mweinzierl@accessinter.net	<b>India</b>	ROHDE & SCHWARZ India Pvt. Ltd. 244, Okhla Industrial Area, Phase-III New Delhi 110020	+91 (11) 632 63 81 (-3 85) +91 (11) 632 63 73 sales@rsindia.rohde-schwarz.com services@rsindia.rohde-schwarz.com
<b>Egypt</b>	U.A.S. Universal Advanced Systems 31 Manshiet El-Bakry Street Heliopolis 11341 Cairo	+20 (2) 455 67 44 +20 (2) 256 17 40 an_uas@intouch.com	<b>Indonesia</b>	ROHDE & SCHWARZ Representative Office Jakarta Menara Rajawali, 24th Floor JL. Mega Kuningan Lot # 5.1 Kawasan Mega Kuningan Jakarta 12950	+62 (21) 576 16 02 +62 (21) 576 16 04 sales@rsbj.rohde-schwarz.com services@rsbj.rohde-schwarz.com
<b>El Salvador</b>	siehe / see Mexico (EPSA)		<b>Iran</b>	Islam. Rep. Of Iran ROHDE & SCHWARZ IRAN Ave. Dr. Beheshti/Ave. Pakistan/ 12th Street No. 1 Tehran 15317	+98 (21) 873 02 82 und -54 78 +98 (21) 873 02 83
<b>Estonia</b>	ROHDE & SCHWARZ DANMARK A/S Estonian Branch Office Narva mnt. 13 10151 Tallinn	+372 (6) 14 31 23 +372 (6) 14 31 21 margo.fingling@rsdk.rohde- schwarz.com	<b>Ireland</b>	siehe / see Great Britain	
<b>Finland</b>	Orbis Oy P.O.Box 15 00421 Helsinki 42	+358 (9) 47 88 30 +358 (9) 53 16 04 info@orbis.fi	<b>Israel</b>	EASTRONICS LTD. Messtechnik / T&M Equipment 11 Rozanis St. P.O.Box 39300 Tel Aviv 61392	+972 (3) 645 86 22 +972 (3) 648 66 66 david_hasky@easx.co.il
<b>France</b>	ROHDE & SCHWARZ FRANCE Immeuble "Le Newton" 9-11, rue Jeanne Braconnier 92366 Meudon La Forêt Cédex	+33 (1) 41 36 10 00 +33 (1) 41 36 11 73	<b>Israel</b>	J.M. Moss Engineering Ltd. Kommunikationstechnik/ Communications Equipment 9 Oded Street P.O.Box 967 52109 Ramat Gan	+972 (3) 631 20 57 +972 (3) 631 40 58 jmoss@zahar.net.il
<b>France</b>	Niederlassung/Subsidiary Rennes Sigma 1 Rue du Bignon F-35135 Chantepie	+33 (2) 99 51 97 00 +33 (2) 99 41 91 31	<b>Italy</b>	ROHDE & SCHWARZ ITALIA S.p.a. Centro Direzionale Lombardo Via Roma 108 20060 Cassina de Pecchi (MI)	+39 (02) 95 70 42 03 +39 (02) 95 30 27 72 ornella.crippa@rsi.rohde-schwarz.com
<b>France</b>	Niederlassung/Subsidiary Toulouse Technoparc 3 B.P. 501 F-31674 Labège Cédex	+33 (5) 61 39 10 69 +33 (5) 61 39 99 10	<b>Italy</b>	ROHDE & SCHWARZ ITALIA S.p.a. Via Tiburtina 1182 00156 Roma	+39 (06) 41 59 82 18 +39 (06) 41 59 82 70
<b>France</b>	Aix-en-Provence	+33 (4) 94 07 39 94 +33 (4) 94 07 55 11	<b>Japan</b>	ADVANTEST Corporation RS Sales Department Shinjuku-NS Building, 4-1 Nishi-Shinjuku Tokyo 163-08	+81 (3) 33 42 75 53 +81 (3) 53 22 72 70 yoshimu@inst.advantest.co.jp
<b>France</b>	Office Lyon	+33 (4) 78 29 88 10 +33 (4) 78 29 94 71	<b>Jordan</b>	Jordan Crown Engineering & Trading Co. Jabal Amman, Second Circle Youssef Ezideen Street P.O.Box 830414 Amman, 11183	+962 (6) 462 17 29 +962 (6) 465 96 72 jocrown@go.com.jo
<b>France</b>	Office Nancy	+33 (3) 83 54 51 29 +33 (3) 83 55 39 51	<b>Kazakhstan</b>	ROHDE & SCHWARZ Kazakhstan Representative Office Almaty Pl. Respubliki 15 480013 Almaty	+7 (32) 72 63 55 55 +7 (32) 72 63 46 33
<b>Ghana</b>	KOP Engineering Ltd. P.O. Box 11012 3rd Floor Akai House, Osu Accra North	+233 (21) 77 89 13 +233 (21) 701 06 20			

<b>Kenya</b>	Excel Enterprises Ltd Dunga Road P.O.Box 42 788 Nairobi	+254 (2) 55 80 88 +254 (2) 54 46 79	<b>Norway</b>	ROHDE & SCHWARZ NORGE AS Olaf Helsestets vei 1 0694 Oslo	+47 (23) 38 66 00 +47 (23) 38 84 70
<b>Korea</b>	ROHDE & SCHWARZ Korea Ltd. 83-29 Nonhyun-Dong, Kangnam-Ku Seoul, REP. of KOREA 135-010	+82 (2) 514 45 46 +82 (2) 514 45 49 sales@rskor.rohde-schwarz.com service@rskor.rohde-schwarz.com	<b>Oman</b>	Mustafa Sultan Science & Industry Co. LLC. P.O.Box 3340 Postal Code 112 Ruwi	+968 602009 od. 567744 +968 607066 od. 560599 siteam@omantel.net.om
<b>Kuwait</b>	Group Five Trading & Contracting Co. P.O. Box 26645 Safat 13127	+965 (244) 91 72/73/74 +965 (244) 95 28	<b>Pakistan</b>	TelcoNet Communications & Engineering 42-A, Margalla Road, F-8/3 Islamabad	+92 (51) 226 31 20 +92 (51) 226 32 11 tnc@brain.net.pk
<b>Latvia</b>	ROHDE & SCHWARZ DANMARK A/S Latvian Branch Office Merkela iela 21-301 1050 Riga	+371 (7) 50 23 55 +371 (7) 50 23 60 rskd@rskd.rohde-schwarz.com	<b>Papua-New Guinea</b>	siehe / see Australia	
<b>Lebanon</b>	ROHDE & SCHWARZ Liaison Office c/o Haji Abdullah Alireza Co. Ltd. P.O.Box 361 Riyadh 11411	+966 (1) 465 64 28 Ext. 303 +966 (1) 465 64 28 Ext. 229 chris.porzky@rsd.rohde-schwarz.com	<b>Peru</b>	BMP INGENIEROS S.A. Av. José Gálvez Barrenechea 645 Urb. Corpac Lima 41	+51 (1) 225 40 30 +51 (1) 475 15 13 wmelgarejo@bmp.com.pe
<b>Liechtenstein</b>	siehe / see Switzerland		<b>Philippines</b>	MARCOM INDUSTRIAL EQUIPMENT, Inc. 6-L Mezzanine Suite, Vernida I Condominium 120 Amorsolo St. Legaspi Village Makati City/Philippines 3117	+63 (2) 813 29 31 +63 (2) 817 05 07 marcom@i-next.net
<b>Lithuania</b>	ROHDE & SCHWARZ DANMARK A/S Lithuanian Office Lukiskiu 5-228 2600 Vilnius	+370 (2) 22 46 62 +370 (2) 22 46 62	<b>Poland</b>	ROHDE & SCHWARZ Österreich SP.z o.o. Przedstawicielstwo w Polsce ul. Stawki 2, Pietro 28 00-193 Warszawa	+48 (22) 860 64 94 +48 (22) 860 64 99 rohdepl@rsoe.rohde-schwarz.com
<b>Luxembourg</b>	siehe / see Belgium		<b>Portugal</b>	TELERUS Sistemas de Telecomunicacoes S.A. Rua General Ferreira Martins Lote 6, 2º B 1495-137 Algés	+351 (21) 412 35 90 +351 (21) 412 36 00 telerus@mail.telepac.pt
<b>Malaysia</b>	DAGANG TEKNIK SDN . BHD. No. 9, Jalan SS 4D/2 Taman People's Park Selangor Darul Ehsan 47301 Petaling Jaya	+60 (3) 703 55 68 +60 (3) 703 34 39 danik@tm.net.my	<b>Republic of Cyprus</b>	HINIS TELECAST LTD. P.O.Box 432 Agiou Thoma 18 Kiti 6304 Larnaca	+357 (4) 42 51 78 +357 (4) 42 46 21 hinis@logos.cy.net
<b>Malta</b>	ITEC International Technology Ltd B'Kara Road San Gwann SGN 08	+356 (3) 743 00 or (3) 743 29 +356 (3) 743 53 sales@itec.com.mt	<b>Romania</b>	ROHDE & SCHWARZ Representation Office Bucharest Str. Uranus 98 Sc. 2, Et. 5, Ap. 36 76102 Bucuresti, Sector 5	+40 (1) 410 68 46 +40 (1) 411 20 13 rohdero@rsoe.rohde-schwarz.com
<b>Mexico</b>	Electroingenieria de Precision, S.A. (EPSA) Uxmal 520 Colonia Vertiz Narvarte 03600 Mexico D.F.	+52 (5) 559 76 77 +52 (5) 575 33 81 rwwolf@epsa-mex.com	<b>Russian Federation</b>	ROHDE & SCHWARZ Representative Office Moscow Kazachy per. 7 109017 Moscow	+7 (095) 234 49 62 +7 (095) 234 49 63 rohderus@rsoe.rohde-schwarz.com
<b>Mexico</b>	Tektronix S.A. de C.V. Col. Insurgentes Cuicuilco Del. Coyoacán 04530 Mexico, D.F.	+52 (5) 666 63 33 +52 (5) 666 63 36 jose.delgado@tektronix.com	<b>Saudi Arabia</b>	Mr. Chris Porzky ROHDE & SCHWARZ International GmbH c/o Haji Abdullah Alireza Co. Ltd. P.O.Box 361 Riyadh 11411	+966 (1) 465 64 28 Ext. 303 +966 (1) 465 642 8 Ext. 229 chris.porzky@rsd.rohde-schwarz.com
<b>Netherlands</b>	ROHDE & SCHWARZ NEDERLAND B.V. Perkinsbaan 1 3439 ND Nieuwegein	+31 (30) 600 17 00 +31 (30) 600 17 99 info@rsn.rohde-schwarz.com	<b>Singapore</b>	INFOTEL TECHNOLOGIES LTD. 19 Tai Seng Drive #02-01 HeShe Building Singapore 535227	+65 (2) 87 68 22 +65 (2) 84 95 55 general@infotel.com.sg
<b>Nepal</b>	Abishek Trade Links (P) Ltd. P.O.Box 9700 Kathmandu	+977 (1) 25 69 30 +977 (1) 24 25 73 durbar@hotel.mos.com.np	<b>Singapore</b>	ROHDE & SCHWARZ Support Centre Asia PTE Ltd. 1 Kaki Bukit View #04-05/07 Techview Singapore 415941	+65 (8) 46 37 10 +65 (8) 46 00 29 veronica.tan@rssg.rohde-schwarz.com
<b>New Zealand</b>	Nichecom Level 1, Tawa Plaza 210 Main Road Tawa, Wellington	+64 (4) 232 32 33 +64 (4) 232 32 30 rob@nichecom.co.nz	<b>Slovak Republic</b>	Specialne systémy a software, a.s. Svrčia ul. 841 04 Bratislava	+421 (7) 65 42 25 29 +421 (7) 65 42 07 68 3s@internet.sk
<b>Nicaragua</b>	siehe / see Mexico (EPSA)		<b>Slovenia</b>	ROHDE & SCHWARZ Representation Ljubljana Tbilisjska 89 1000 Ljubljana	+386 (61) 423 46 51 +386 (61) 423 46 11 rohdesl@rsoe.rohde-schwarz.com
<b>Nigeria</b>	Ferrostaal (NIGERIA) Ltd. P.O. Box 72021 27/29 Adeyamo Alkaija Street Victoria Island Lagos	+234 (1) 262 00 60 +234 (1) 262 00 64 fs-nig@linkserve.com.ng			



<b>South Africa</b>	Protea Data Systems (Pty.) Ltd. Communications and Measurement Division Private Bag X19 Bramley 2018	+27 (11) 719 57 00 or -57 91 +27 (11) 786 58 91 unicm@protea.co.za or colin.forbes@protea.co.za	<b>United Arab Emirates</b>	ROHDE & SCHWARZ Liaison Office Dubai P.O.Box 5267 Dubai	+971 (4) 394 48 29 +971 (4) 394 47 94 kahmann@emirates.net.ae
<b>Spain</b>	ROHDE & SCHWARZ ESPANA S.A. Salcedo, 11  28034 Madrid	+34 (91) 334 10 70 +34 (91) 329 05 06 rema@rem.a.es	<b>United Arab Emirates</b>	ROHDE & SCHWARZ Emirates L.L.C. P.O.Box 31156 Abu Dhabi	+971 (2) 631 20 40 +971 (2) 631 30 40 rsuaeam@emirates.net.ae
<b>Sri Lanka</b>	LANKA AVIONICS 658/1/1, Negombo Road Mattumagalala Ragama	+94 (1) 95 66 78 +94 (1) 95 83 11 lankavio@sltnet.lk	<b>United Kingdom</b>	ROHDE & SCHWARZ UK Ltd. Ancells Business Park Fleet Hampshire GU 51 2UZ England	+44 (1252) 81 13 77 +44 (1252) 81 14 47
<b>Sudan</b>	SolarMan Co. Ltd. P.O.Box 11 545 North of Fraouq Cementry 6/7/9 Bldg. 16 Karthoum	+249 (11) 47 31 08 +249 (11) 47 31 38 solarman29@hotmail.com	<b>Uruguay</b>	AEROMARINE S.A. Cerro Largo 1497 11200 Montevideo	+598 (2) 400 39 62 +598 (2) 401 85 97 aeromar@adinet.com.uy
<b>Sweden</b>	ROHDE & SCHWARZ SVERIGE AB Flygfälskgatan 15 128 30 Skarpnäck	+46 (8) 605 19 00 +46 (8) 605 19 80 info@rss.se	<b>USA</b>	ROHDE & SCHWARZ, Inc. Broadcast Equipment Comm. Equipment (US Headquarters) 7150-K Riverwood Drive Columbia, MD 21046	+1 (410) 910 78 00 +1 (410) 910 78 01 rsatv@rsa.rohde-schwarz.com rsacomms@rsa.rohde-schwarz.com
<b>Switzerland</b>	Roschi Rohde & Schwarz AG Papiermühlestr. 145 3063 Ittigen	+41 (31) 922 15 22 +41 (31) 921 81 01 marianne.balsiger@roschi.rohde-schwarz.com	<b>USA</b>	Rohde & Schwarz c/o Tektronix Inc. Marketing & Support Center / T&M Equipment 2540 SW Alan Blumlein Way M/S 58-925 Beaverton, OR 97077-0001	+1 (503) 627 26 84 +1 (503) 627 25 65 info@rsa.rohde-schwarz.com
<b>Syria</b>	Electro Scientific Office  Baghdad Street Dawara Clinical Lab. Bldg P.O.Box 8162 Damascus	+963 (11) 231 59 74 +963 (11) 231 88 75	<b>USA</b>	Rohde & Schwarz c/o Tektronix Inc. System Support Center/ T&M Systems & Services 2540 SW Alan Blumlein Way M/S 58-925 Beaverton, OR 97077-0001	+1 (503) 627 33 06 +1 (503) 627 25 65 info@rsa.rohde-schwarz.com
<b>Taiwan</b>	Lancer/System Communication Co. Ltd.  16F, No. 30, Pei-Ping East Road Taipei	+886 (2) 23 91 10 02 +886 (2) 23 95 82 83 info@lancercomm.com.tw	<b>Venezuela</b>	EQUILAB TELECOM C.A. Centro Seguros La Paz Piso 6, Local E-61 Ava. Francisco de Miranda Boleita, Caracas 1070	+58 (2) 12 34 46 26 +58 (2) 122 39 52 05 r_ramire@equilabtelecom.com.ve
<b>Tanzania</b>	Security Systems Tanzania Ltd. P.O. Box 7512 Dunga Street Plot 343/345 Dar es Salaam	+255 (22) 276 00 37 +255 (22) 276 02 93 sstl@twiga.com	<b>Venezuela</b>	REPRESENTACIONES BOPIC S.A. Calle C-4 Qta. San Jose Urb. Caurimare Caracas 1061	+58 (2) 129 85 46 90 +58 (2) 129 85 39 94 incotr@cantv.net
<b>Thailand</b>	SCHMIDT SCIENTIFIC (THAILAND) Ltd. 63 Government Housing Bank Bldg. Tower II, 19th floor, Rama 9 Rd. Huaykwang, Bangkok Bangkok 10320	+66 (2) 643 13 30-9 +66 (2) 643 13 40 kamthon@schmidtthailand.com	<b>Vietnam</b>	Schmidt Vietnam Co., Ltd. Intern. Technology Centre 8/F, Schmidt Tower, Hanoi Cau Giay, Tu Liem, IPO Box 89 Hanoi	+84 (4) 834 61 86 +84 (4) 834 61 88 svnhn@schmidtgroup.com
<b>Thailand</b>	TPP Operation Co., Ltd. 41/5 Mooban Tarinee Boromrajchonnee Road Talingchan, Bangkok 10170	+66 (2) 880 93 47 +66 (2) 880 93 47			
<b>Turkey</b>	ROHDE & SCHWARZ International GmbH Liaison Office Istanbul Bagdad Cad. 191/3, Arda Apt. B-Blok 81030 Selamicesme-Istanbul	+90 (216) 385 19 17 +90 (216) 385 19 18 rsturk@superonline.com			
<b>Ukraine</b>	ROHDE & SCHWARZ Representative Office Kiev 4, Patris Loumoumba ul 252042 Kiev	+38 (044) 268 60 55 +38 (044) 268 83 64 rohdeukr@rsoe.rohde-schwarz.com			
<b>United Arab Emirates</b>	ROHDE & SCHWARZ International GmbH Liaison Office Abu Dhabi P.O. Box 31156 Abu Dhabi	+971 (2) 633 56 70 +971 (2) 633 56 71 michael.rogler@rsd.rohde-schwarz.com			
<b>United Arab Emirates</b>	ROHDE & SCHWARZ Bick Mobile Communication P.O.Box 17466 JAFZ, PPU ZG-07 Dubai	+971 (4) 883 71 35 +971 (4) 883 71 36 www.rsibick.de			

# Contents of Manuals for EMI Test Receiver ESPI

## Operating Manual ESPI

The operating manual describes the following models and options of EMI test receiver ESPI:

- ESPI3 9 kHz to 3 GHz
- ESPI7 9 kHz to 7 GHz
  
- Option ESPI B2 preselector
- Option FSP-B4 OCXO - reference oscillator
- Option FSP-B6 TV trigger
- Option FSP-B9 tracking generator
- Option FSP-B10 external generator control
- Option FSP-B16 LAN interface

This operating manual contains information about the technical data of the instrument, the setup functions and about how to put the instrument into operation. It informs about the operating concept and controls as well as about the operation of the ESPI via the menus and via remote control. Typical measurement tasks for the ESPI are explained using the functions offered by the menus and a selection of program examples.

Additionally the operating manual includes information about maintenance of the instrument and about error detection listing the error messages which may be output by the instrument. It is subdivided into the data sheet plus 9 chapters:

- The data sheet** informs about guaranteed specifications and characteristics of the instrument.
- Chapter 1** describes the control elements and connectors on the front and rear panel as well as all procedures required for putting the ESPI into operation and integration into a test system.
- Chapter 2** gives an introduction to typical measurement tasks of the ESPI which are explained step by step.
- Chapter 3** describes the operating principles, the structure of the graphical interface and offers a menu overview.
- Chapter 4** forms a reference for manual control of the ESPI and contains a detailed description of all instrument functions and their application. The chapter also lists the remote control command corresponding to each instrument function.
- Chapter 5** describes the basics for programming the ESPI, command processing and the status reporting system.
- Chapter 6** lists all the remote-control commands defined for the instrument. At the end of the chapter a alphabetical list of commands and a table of softkeys with command assignment is given.
- Chapter 7** contains program examples for a number of typical applications of the ESPI.
- Chapter 8** describes preventive maintenance and the characteristics of the instrument's interfaces.
- Chapter 8** gives a list of error messages that the ESPI may generate.
- Chapter 9** contains a list of error messages.
- Chapter 10** contains an index for the operating manual.

**Service Manual - Instrument**

The service manual - instrument informs on how to check compliance with rated specifications, on instrument function, repair, troubleshooting and fault elimination. It contains all information required for the maintenance of ESPI by exchanging modules.

# Contents - Chapter 1 " Preparing for Operation "

## 1 Preparing for Operation

<b>Description of Front and Rear Panel Views .....</b>	<b>1.1</b>
Front View.....	1.1
Rear View .....	1.9
<b>Getting Started with the instrument.....</b>	<b>1.12</b>
Preparing the instrument for Operation .....	1.12
Setting up the Instrument .....	1.12
Stand-alone Operation .....	1.12
Safety Instruction for Instruments with Tilttable Feet .....	1.13
Rackmounting .....	1.13
EMI Protection Measures .....	1.14
Connecting the Instrument to the AC Supply.....	1.14
Switching the Instrument on/off .....	1.14
Switching on the Instrument .....	1.15
Startup Menu and Booting.....	1.15
Switching off the ESPI.....	1.15
Power-Save Mode .....	1.16
Recalling the most recent instrument settings.....	1.16
<b>Functional Test .....</b>	<b>1.16</b>
<b>Windows NT .....</b>	<b>1.17</b>
<b>Connecting an External Keyboard .....</b>	<b>1.18</b>
<b>Connecting a Mouse.....</b>	<b>1.19</b>
<b>Connecting an External Monitor .....</b>	<b>1.20</b>
<b>Connecting a Printing Device .....</b>	<b>1.21</b>
Installation of a Network Printer (with option FSP-B16 only) .....	1.27
<b>Installing Windows NT Software .....</b>	<b>1.30</b>

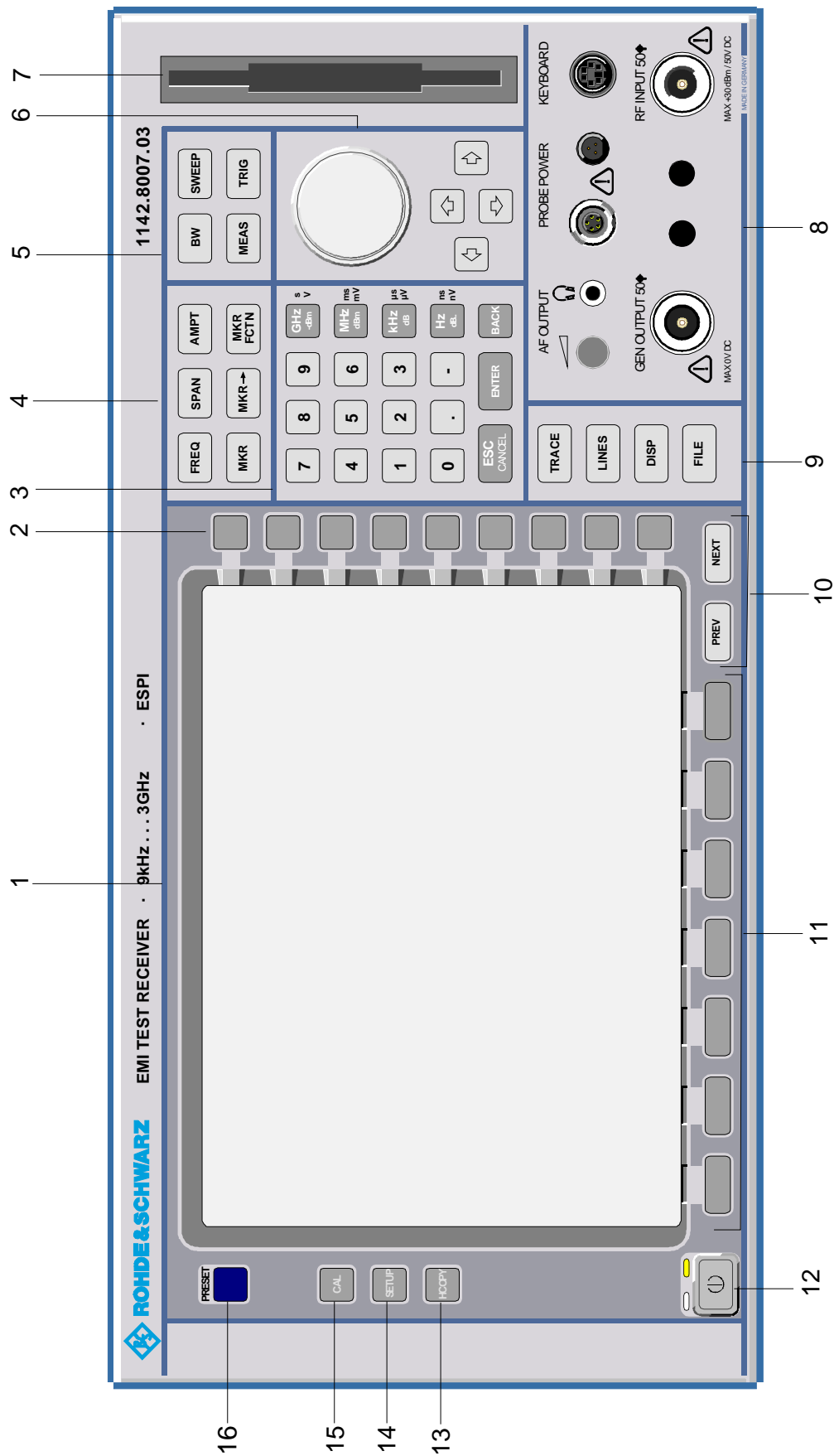

Fig. 1-1 Front View

# 1 Preparing for Operation

Chapter 1 describes the controls and connectors of the test receiver ESPI by means of the front and rear view. Then follows all the information that is necessary to put the instrument into operation and connect it to the AC supply and to external devices.

A more detailed description of the hardware connectors and interfaces can be found in chapter 8. Chapter 2 provides an introduction into the operation of the ESPI by means of typical examples of configuration and measurement; for the description of the concept for manual operation and an overview of menus refer to chapter 3.

For a systematic explanation of all menus, functions and parameters and background information refer to the reference part in chapter 4.

For remote control of the ESPI refer to the general description of the SCPI commands, the instrument model, the status reporting system, and command description in chapter 5 and 6.

## Description of Front and Rear Panel Views

### Front View

<b>1</b>	Display Screen	see Chapter 3
<b>2</b>	Softkeys	see Chapter 3
<b>3</b>		data input 0...9 input numbers . input decimal point - change sign ESC – close input field (for uncompleted or already closed inputs, the original entry is kept) CANCEL – erase the current entry in input field (beginning of an input) – close message window (status, error and warning messages) ENTER close the data input. BACK – erase last character input for uncompleted input – restore previous input (undo)

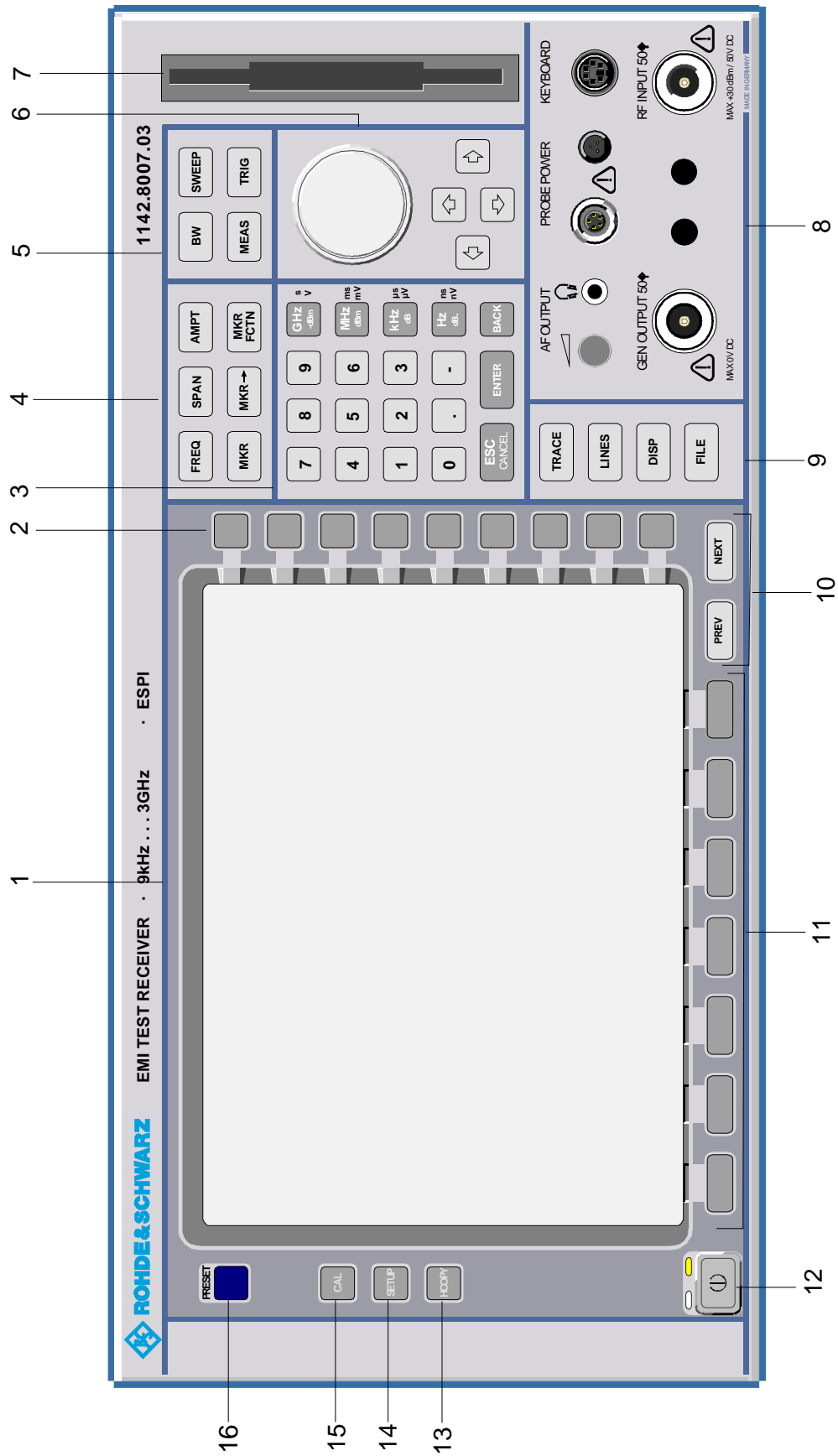

Fig. 1-1 Front View



data input

- GHz s     The units keys close the data input and define the multiplication factor for each basic unit.
- dBm V     For dimension-less or alphanumeric inputs, the units keys have weight 1.
- MHz ms     They behave, in this case, like the ENTER key.
- dBm mV
- kHz μs
- dB μV
- Hz ns
- dB.. nV

see Chapter 3

4



- FREQ     Set frequency axis
- SPAN     Set span
- AMPT     Set level indication and configure RF input.
- MKR     Select and set standard marker and delta marker functions.
- MKR->     Change instrument settings via markers
- MKR     Select further marker and delta marker functions
- FCTN

see Chapter 4

5



- BW     –Set resolution bandwidth, video bandwidth and sweep time, –Set coupling of these parameters
- SWEEP     Select sweep or set scan parameters
- MEAS     Select and set power measurements or select detectors and measurement time
- TRIG     Set trigger sources

see Chapter 4



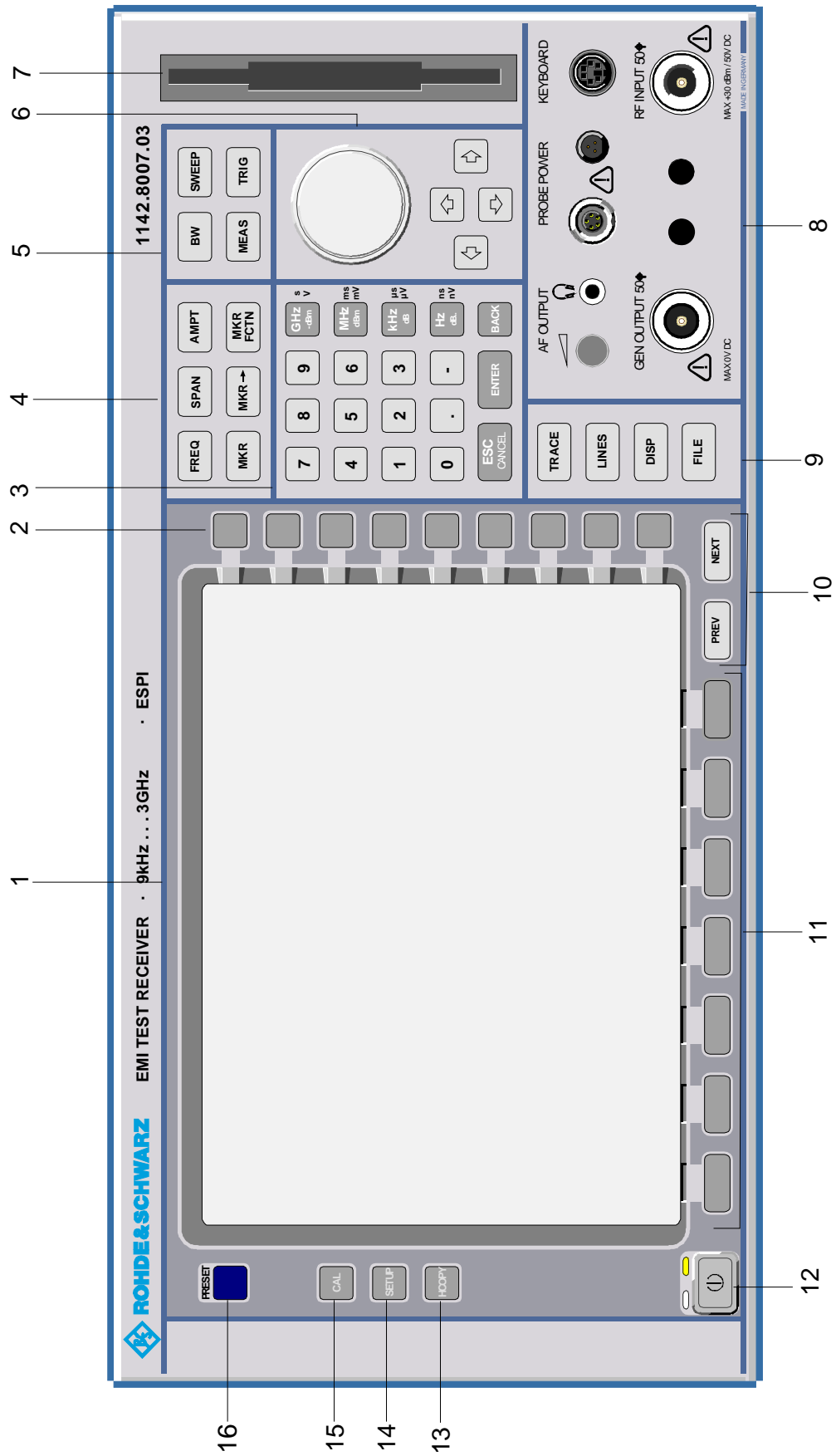
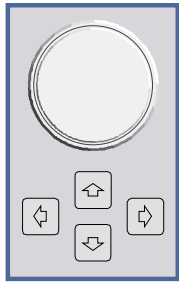

Fig. 1-1 Front View

6



Key group for entering data and for cursor movement

see Chapter 3

- Cursor keys – Move the cursor within the input fields and tables.
- Vary the input value.
  - Define the direction of movement for the roll-key.

- Roll-key – Vary input values.
- Move markers and limits.
  - Select letters in the help line editor.
  - Move cursor in the tables
  - Close data input (ENTER)

7

3 1/2" diskette drive; 1.44 MByte

8

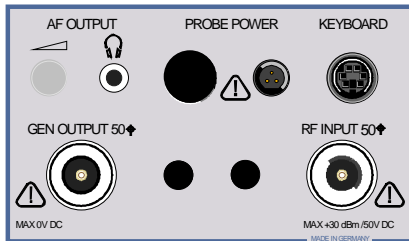

AF OUTPUT



Volume control  
Head phone connector

PROBE POWER

Power supply and coded socket (+15 V/ -12 V) for accessories

KEYBOARD

Connector for an external keyboard

RF INPUT



**Caution:**

*The maximum DC voltage is 50 V, the maximum power is 1 W ( $\hat{=}$  30 dBm) at  $\geq 10$  dB attenuation.*

RF input

see Chapter 8

see Chapter 8

9



TRACE Select and activate traces and detectors

see Chapter 4

LINES Set limit lines

DISP Configure display

- FILE – Save and recall instrument data
- Configuration of memory media and data

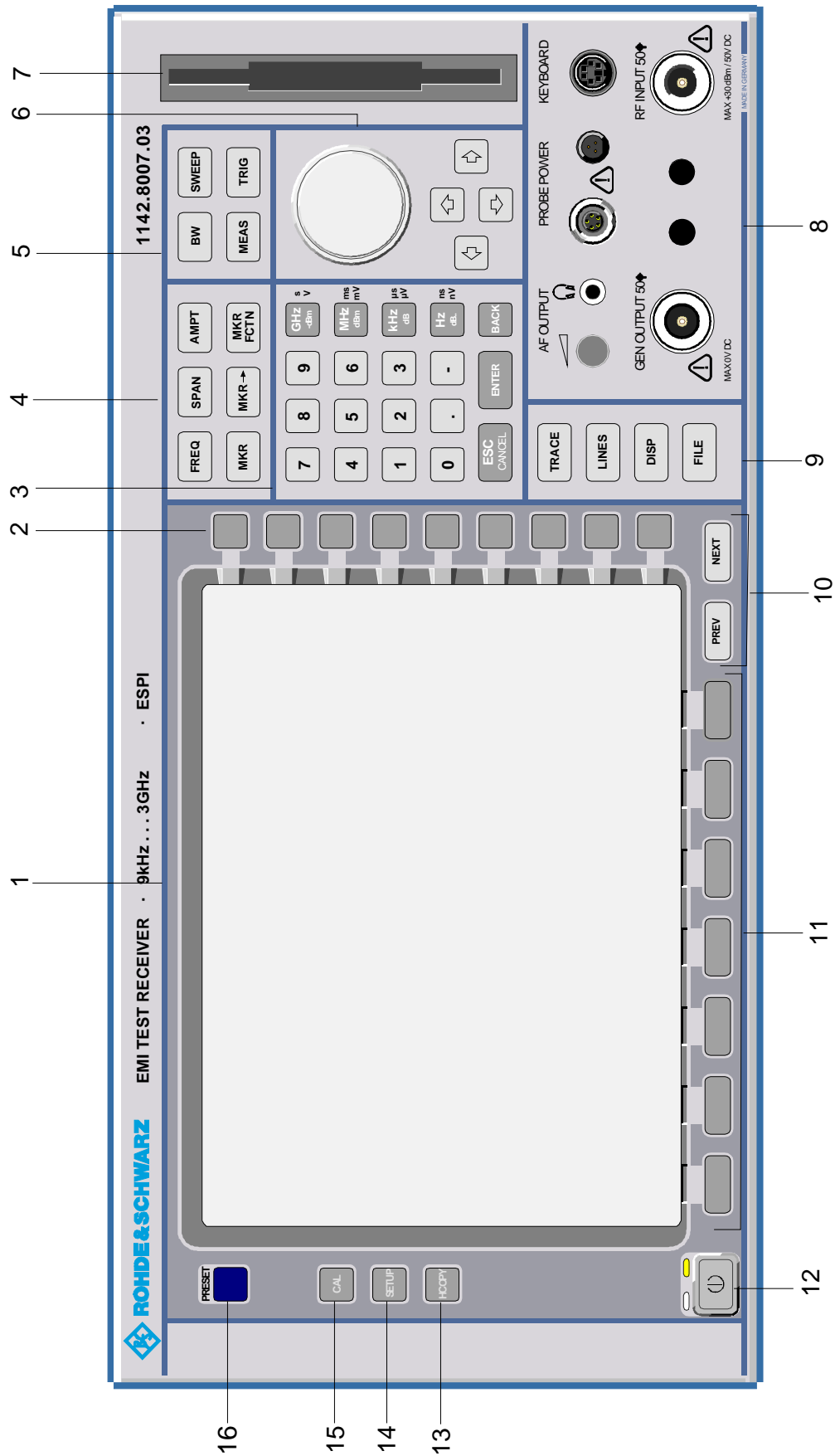



Fig. 1-1 Front View

**10**

	<p>Menu-change keys</p> <p>NEXT Change to side menu</p> <p>PREV Call main menu</p>	<p>see Chapter 3</p>
---	--	----------------------

**11**

	<p>Hotkeys</p>	<p>see Chapter 3</p>
--	----------------	----------------------

**12**

	<p>ON/STANDBY switch</p>	<p>see Chapter 1</p>
---	--------------------------	----------------------

**13**

	<p>Configure and start a print job</p>	<p>see Chapters 1 and 4</p>
---	--	-----------------------------

**14**

	<p>Define general configuration</p>	<p>see Chapter 4</p>
---	-------------------------------------	----------------------

**15**

	<p>Record correction data</p>	<p>see Chapter 4</p>
---	-------------------------------	----------------------

**16**

	<p>Call default settings</p>	<p>see Chapter 4</p>
---	------------------------------	----------------------

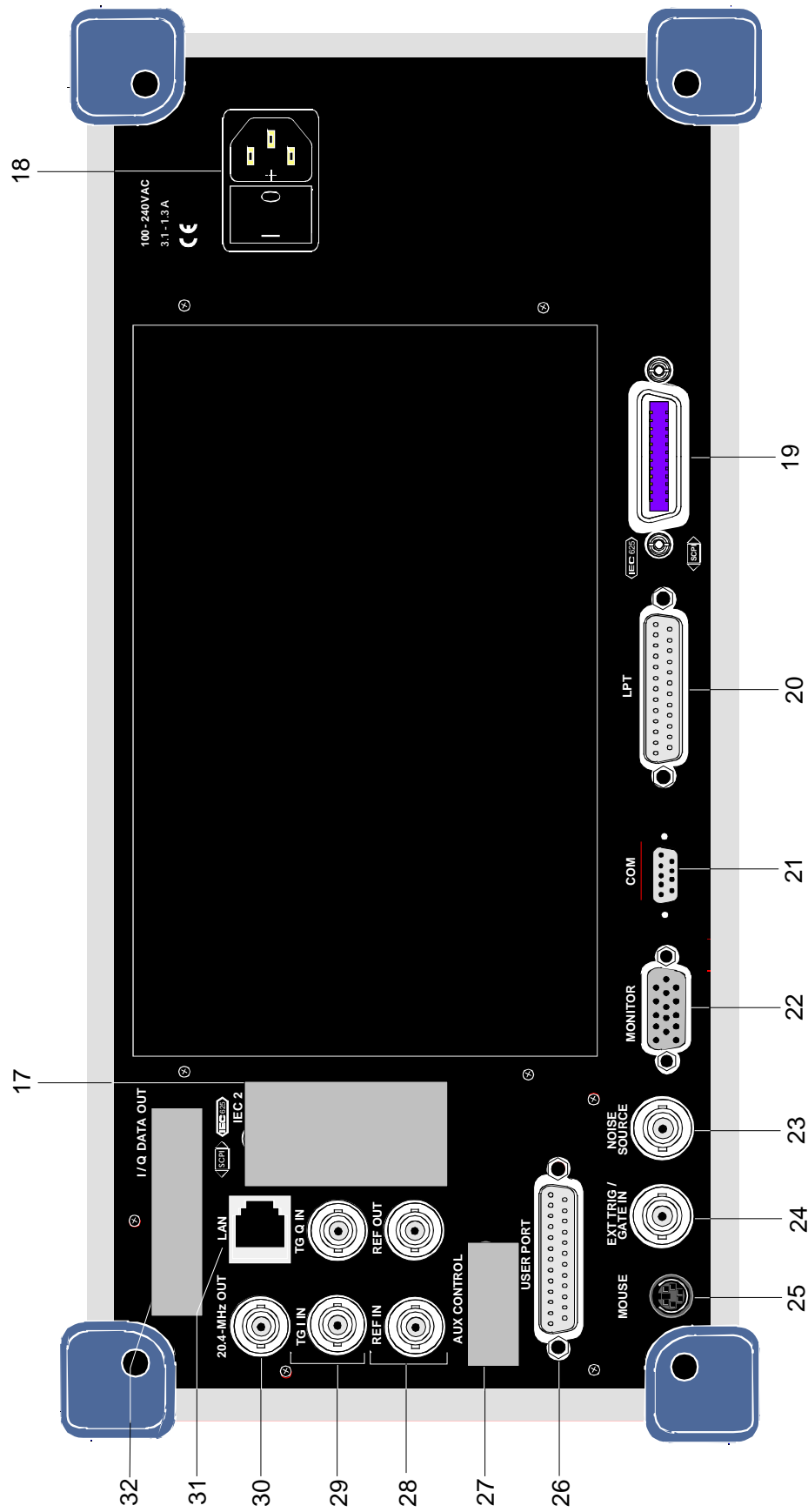
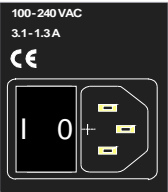
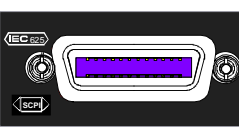
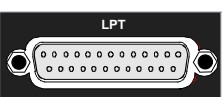
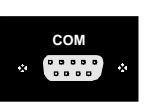
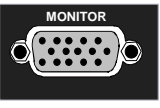



Fig. 1-2 Rear View

Rear View

<b>17</b>		
	Reserved for options	see Chapter 8
<b>18</b>		
 <p>100-240 VAC 3.1-1.3A CE</p>	Power switch and AC power connector	see Chapter 1
<b>19</b>		
	IEC/IEEE bus-connector	see Chapter 8
<b>20</b>		
	Parallel interface connector (printer connector)	see Chapter 8
<b>21</b>		
	Connector for a serial interface (9-pin socket; COM)	see Chapter 8
<b>22</b>		
	Connector for an external monitor	see Chapter 8
<b>23</b>		
	Output connector for an external noise source	see Chapter 8
<b>24</b>		
	Input connector for an external trigger or an external gate signal	see Chapter 8

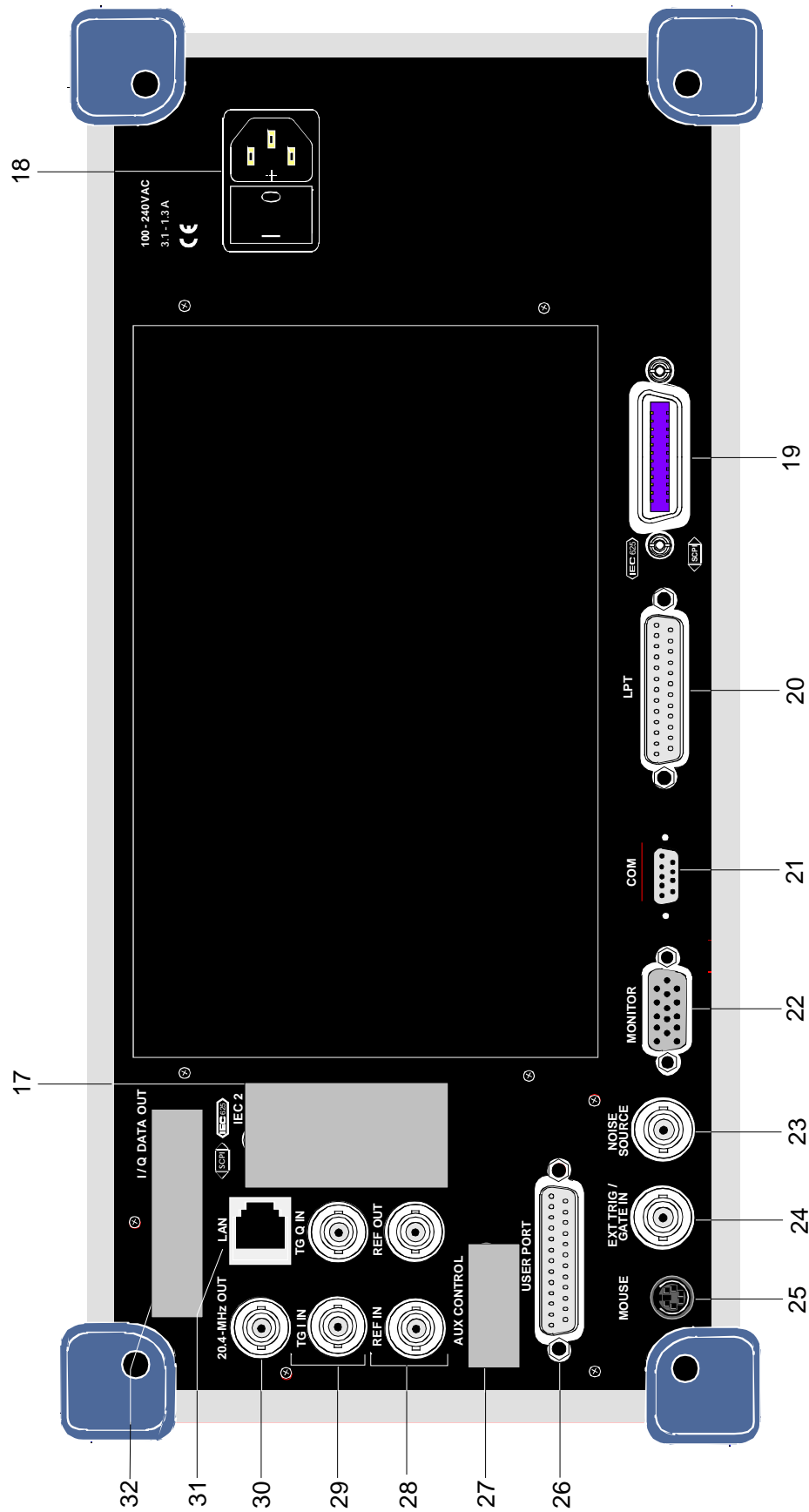

Fig. 1-2 Rear View

## 25



Connector for a PS/2 mouse

see Chapter 8

## 26

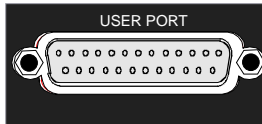

USER PORT Output/input. TTL levels  
(Low < 0,4 V, High > 2 V).  
Internal +5 V power supply voltage.  
Maximum load current 100 mA.

see Chapter 8

## 27

Reserved for options

## 28

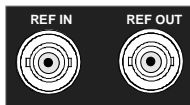

REF IN Input connector for an external reference (10 MHz)

REF OUT Output connector for an internal reference (10 MHz)

## 29

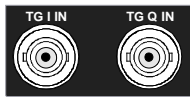

TG I IN Input connector for external modulation of tracking generator (option FSP-B9)

TG Q IN Input connector for external modulation of tracking generator (option FSP-B9)

see Chapter 4

## 30

Output connector for 20.4 MHz IF  
(not if option FSP-B6 is built in)

see Chapter 8

Selectable CCVS input/output  
(only if option FSP-B6 is built in)

see Chapter 4 and 8

## 31



LAN Interface (FSP-B16)

see Chapter 4

## 32

Reserved for options



## Getting Started with the instrument

The following section describes how to activate the instrument and how to connect external devices like eg printer and monitor.

Chapter 2 explains the operation of the instrument using simple measurement examples.



### **Important note:**

*Before turning the instrument on, care should be taken that the following conditions are fulfilled:*

- *instrument covers are in place and tightened by the corresponding screws,*
- *fan openings are free from obstructions,*
- *signal levels at the input connectors are all within specified limits,*
- *signal outputs are connected correctly and not overloaded.*

***Ignoring these conditions may cause damage to the instrument .***

## Preparing the instrument for Operation

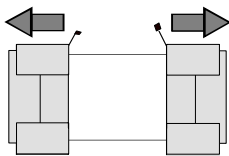

remove protective caps

- Take the instrument out of the shipping box and check whether the items listed in the packing list and in the lists of accessories are all included.
- Remove the two protective caps from the front and rear of the ESPI and carefully check the instrument for damage.
- Should the instrument be damaged, immediately notify the transportation company that shipped the instrument to you and keep the box and packing material.
- For further transport or shipment of the ESPI the original packing should also be used. It is recommended to keep at least the two protective caps for front and rear side in order to prevent damage to the controls and connectors.

## Setting up the Instrument

### Stand-alone Operation

The instrument is designed for use under general laboratory conditions. The ambient conditions required at the operational site are as follows:

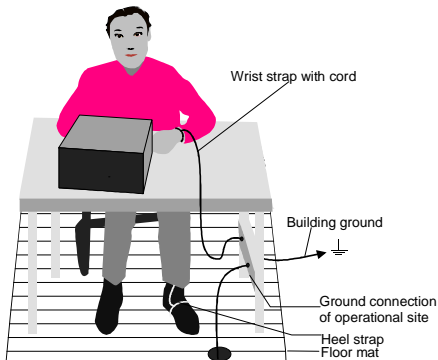

- The ambient temperature must be in the range indicated in the data sheet.
- All fan openings must be unobstructed and the air flow at the rear panel and at the side-panel perforations must not be obstructed. The distance to the wall should be at least 10 cm.
- The mounting surface should be flat.
- In order to avoid damage of electronic components of the device under test due to electrostatic discharge on manual touch, protection of the operational site against electrostatic discharge is recommended.

## Safety Instruction for Instruments with Tilttable Feet



### Warning

The feet must be fully folded in or out. Only in this way can the stability of the instrument be guaranteed and reliable operation be ensured. With the feet out, the total load for the feet must not exceed 500 N (own weight and additional units put onto the instrument). These units must be secured against slipping (e.g. by locking the feet of the unit at the top side of the enclosure).

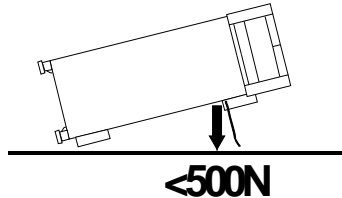

When shifting the instrument with the feet out, the feet might collapse and fold in. To avoid injuries, the instrument must therefore not be shifted with the feet out.

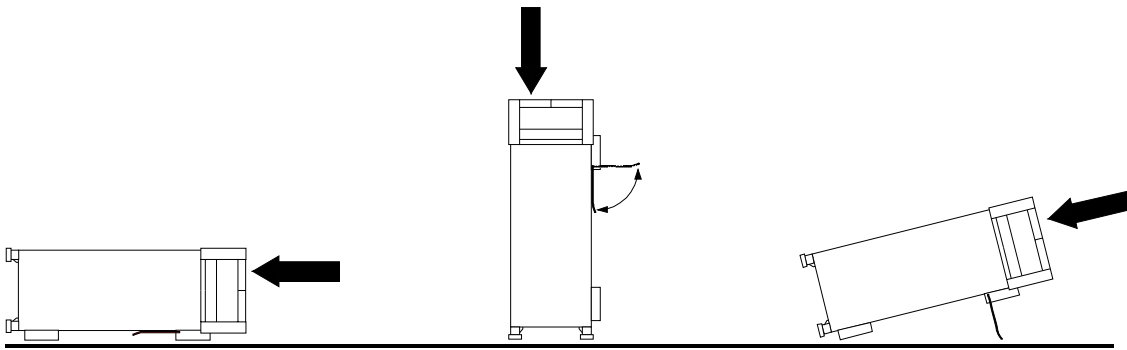

The instrument can be operated in any position.

## Rackmounting



### Important Note:

For rack installation, ensure that the air flow at the side-panel perforations and the air exhaust at the rear panel are not obstructed.

The instrument may be mounted in a 19" rack by using a rack adapter kit (order number see data sheet). The installation instructions are included in the adapter kit.

## EMI Protection Measures

In order to avoid electromagnetic interference (EMI), the instrument may be operated only when all covers are correctly in place. Only adequately shielded signal and control cables may be used (see recommended accessories).

## Connecting the Instrument to the AC Supply

The ESPI is equipped with an AC voltage selection feature and will automatically adapt itself to the applied AC voltage (range: 100 to 240 VAC, 40 to 400 Hz). External voltage selection or adaptation of the fuses are not necessary. The AC power connector is located on the rear panel (see below).

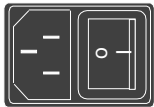

Power connector

- Connect the instrument to the AC power source using the AC power cable delivered with the instrument.

As the instrument is designed according to the regulations for safety class EN61010, it must be connected to a power outlet with earthing contact.

## Switching the Instrument on/off



**Caution:**

**Do not power down during booting.** Such a switch-off may lead to corruption of the hard disk files.

AC power switch on the rear panel

Power switch Power connector

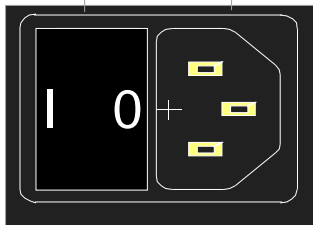

### Power switch

#### Position I = ON

In the I position, the instrument is in standby mode or in operation, depending on the position of the ON/STANDBY key at the front of the instrument.

**Note:**

*The AC power switch may remain ON continuously. Switching to OFF is only required when the instrument must be completely removed from the AC power source.*

#### Position O = OFF

The 0 position implies an all-pole disconnection of the instrument from the AC power source.

ON/STANDBY switch on the front panel

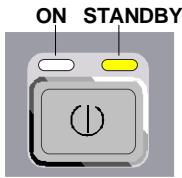

**Caution:**

*In standby mode, the AC power voltage is present within the instrument*

**Standby switch**

The ON/STANDBY switch activates two different operating modes indicated by colored LEDs:

**Operation ON** - ON/STANDBY is depressed

The green LED (ON) is illuminated. The instrument is ready for operation. All modules within the instrument are supplied with power.

**STANDBY** - ON/STANDBY switch is not pressed.

The yellow LED (STANDBY) is illuminated. Only the power supply is supplied with power and the quartz oven is maintained at normal operating temperature.

**Switching on the Instrument**

- In order to switch on the ESPI, set the power switch on the rear panel to position I.
- Set the ESPI to operating mode by pressing the *ON/STANDBY* key on the front panel. The green LED must be illuminated.

**Startup Menu and Booting**

After switching on the instrument, a message indicating the installed BIOS version (eg Analyzer BIOS Rev. 1.2) appears on the screen for a few seconds.

Subsequently Windows NT is booted first and after that the instrument firmware will boot. As soon as the boot process is finished the instrument will start measuring. The settings used will be the one that was active when the instrument was previously switched off, provided no other device configuration than *FACTORY* had been selected with *STARTUP RECALL* in the *FILE* menu.

**Switching off the ESPI**

- Switch the ON/STANDBY key on the front panel to standby mode by pressing it once.  
The ESPI will write the current instrument settings to disk before performing a Windows NT shutdown. At the end of the shutdown procedure the power supply will be switched to STANDBY mode.  
The yellow LED must be illuminated.

Only when removing the ESPI completely from the AC power source:

- Set the power switch at the rear panel to position 0.

## Power-Save Mode

### Display:

The ESPI offers the possibility of switching on a power-save mode for the screen display. The screen is blanked out if no entry is made on the front panel (key, softkey or hotkey and rollkey) during the selected response time.

In order to switch on the power-save mode:

1. Call the *DISPLAY - CONFIG DISPLAY* submenu to configure the screen display:
  - Press *DISP* key
  - Press *CONFIG DISPLAY* softkey
2. Activate the save mode
  - Press *DISPLAY PWR SAVE* softkey.  
The softkey is highlighted in color, thus indicating that the power-save mode is on. At the same time the data entry for the delay time is opened.
3. Define the delay time
  - Enter the required response time in minutes and confirm the entry using the *ENTER* key.  
The screen will be blanked out after the selected time period has elapsed.

### Harddisk:

A power-save mode is preset for the built-in harddisk which is automatically closed down 15 minutes after the last access.

## Recalling the most recent instrument settings

The ESPI is equipped with a battery-powered read/write memory (CMOS-RAM) where instrument settings are saved at power-off. After each power-on, the ESPI is reloaded with the operational parameters which were active just prior to the last power-off (STANDBY or AC power OFF) or were set with STARTUP RECALL (see Chapter 4 "Saving and Recalling Data Sets").

A lithium battery is used to supply power to the CMOS-RAM. As soon as the battery is discharged (expected life time is approx. 5 years), any data stored in CMOS-RAM will be lost. In this case, the factory standard setup is loaded at power-on. For changing batteries please contact your local service representative.

## Functional Test

After turning on the AC power, the ESPI will display the following message on the display screen:

```
Rohde & Schwarz GmbH & Co. KG
Analyzer BIOS      Vx.y
```

After appearance of the above message, a self-test of the digital hardware is performed. Subsequently, the Windows NT controller boots and the measurement screen will appear.

The system self-alignment is activated via *CAL* key, *CAL TOTAL* softkey. The individual results of the self-alignment (PASSED / FAILED) can be displayed in the *CAL* menu (*CAL RESULTS*).

With the aid of the built-in self-test functions (*SETUP* key, *SERVICE*, *SELFTEST* soft keys), the functional integrity of the instrument can be verified and/or defective modules can be localized.

## Windows NT

**Caution:**

*The drivers and programs used under Windows NT are adapted to the measuring instrument. In order to prevent the instrument functions from damage, the settings should only be modified as described below. Existing software may only be modified using update software released by Rohde&Schwarz. Additionally only programs authorized by Rohde&Schwarz for use on the ESPI may be run on the instrument.*

***Do not power down during booting.*** Such a switch-off may lead to corruption of the hard disk files.

The instrument runs under the operating system Windows NT. The computer can be used to install and configure device drivers that were authorized by Rohde&Schwarz. Any further use of the computer function is only allowed under the conditions described in this operating manual.

**Login**

Windows NT requires a login process, during which the user is asked for identification by entering his name and password. As a factory default the instrument is configured for *Auto Login*, ie the login is performed automatically and in the background. The user name used for this is "instrument" and the password is also "instrument" (in small letters).

**Administrator Level**

The NT user account used for the autologin function has administrator access rights.

After a software installation that requires administrator rights (eg the installation of new printer drivers), Service Pack 5 of Windows NT has to be re-installed. The necessity to re-install the service pack is indicated in the corresponding operating manual chapters. The installation of the Service Pack is described in the section "Installing Windows NT Software".

**Calling the Windows NT start menu**

The Windows NT start menu is called using the key combination <CTRL> <ESC>. It is possible to access the required submenus from the start menu by means of the mouse or the cursor keys. In order to return to the measurement screen the button "R&S Analyzer Interface" in the Windows NT task bar can be used.

## Connecting an External Keyboard

**Caution:**

*The keyboard may only be connected when the instrument is switched off (STANDBY). Otherwise, correct operation of the keyboard cannot be guaranteed.*

The ESPI offers a 6-contact PS/2-connector KEYBOARD on the instrument's front panel for the connection of an external PC. It is recommended to use keyboard PSP-Z2 (Order No. 1091.4100.02, English). This keyboard is equipped with a trackball for mouse control.

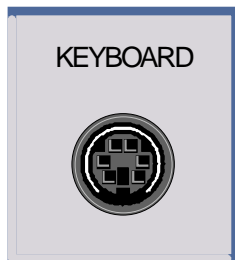

During measurement operations, the keyboard simplifies the input of commentary text, filenames, etc.

The section "Instrument Interfaces" in Chapter 8 contains the interface description of the connector.

After connection of the keyboard and subsequent power-on, the keyboard will be automatically recognized. The default language used is "US keyboard". Special settings such as repetition rate etc. can be performed in the Windows NT menu START - SETTINGS - CONTROL PANEL - KEYBOARD.

## Connecting a Mouse

**Caution:**

*The mouse may only be connected when the instrument is switched off (STANDBY). Otherwise, correct operation of the mouse and instrument cannot be guaranteed.*

In order to ease up operation of Windows NT, the ESPI provides an option for connecting a mouse to the PS/2 mouse connector (MOUSE) at the rear panel of the instrument.

The mouse type supported is "Microsoft mouse". It is available as option PS-B1 (order number 1006.6359.02).

**Note.** *The recommended keyboard PSP-Z2 is equipped with a trackball for mouse control. Connecting an additional mouse will cause interface conflicts and lead to malfunctions of the instrument.*



The section "Instrument Interfaces" in Chapter 8 contains the interface description of the connector.

After connection and subsequent power-on the mouse is automatically recognized. Special settings such as mouse cursor speed etc., can be performed in the Windows NT menu START - SETTINGS - CONTROL PANEL - MOUSE.



## Connecting an External Monitor

**Caution:**

*The monitor may only be connected when the instrument is switched off (STANDBY). Otherwise, the monitor may be damaged.*

*Do not modify the screen driver (display type) and display configuration since this will severely affect instrument operation.*

The instrument is equipped with a rear-panel connector MONITOR for the connection of an external monitor.

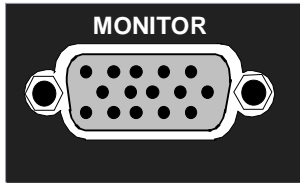

After connecting the external monitor the instrument needs to be rebooted in order to recognize the monitor. After that the measurement screen is displayed on both the external monitor and the instrument. Further settings are not necessary.

## Connecting a Printing Device



**Caution:**

The printing device may be connected only when the instrument is switched off (STANDBY)

**Note:** When installing printer drivers that are not pre-installed on the instrument, the operator is requested to insert the disk with the new driver into drive A. After installation the Service Pack needs to be re-installed (see section "Installing Windows NT Software")

The instrument is prepared for connecting printing devices to two different interfaces in order to create hard copies of the display screen. The *DEVICE* table in menu *HCOPY – DEVICE1/2* indicates the available selection of installed printing devices (see also Chapter 4, section "Documentation of Test Results").

The interface connectors are located on the rear panel:

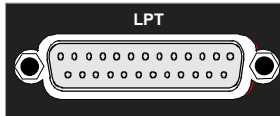

Chapter 8 contains the interface descriptions of the connectors.

After connection of the printing device to the appropriate interface connector, the interface needs to be configured, the printer driver has to be installed and assigned to an interface.

### 1. Connecting keyboard and mouse

For the installation and configuration of printer drivers on the ESPI, it is necessary to connect a keyboard to the front panel and a PS/2 mouse to the rear panel (only in case of using a keyboard without trackball, see sections "Connecting a Mouse" and "Connecting a Keyboard").

### 2. Switching to Windows NT start menu and opening the system control

The combination of keys <CTRL><ESC> is used to switch to the Windows NT start menu. The system control panel is then opened in the NT start menu using the sequence SETTINGS - CONTROL PANEL.

### 3. Configuration of the interface

- |     |  |
|-----|--|
| LPT | Interface LPT needs no configuration.  |
| COM | The COM interface must first be assigned to the operating system (owner = OS) in menu SETUP - GENERAL SETUP. The configuration of the serial interface can then be performed either in the Windows NT menu START - SETTINGS - CONTROL PANEL - PORTS or in the ESPI SETUP - GENERAL SETUP menu. The parameters <i>Baud Rate</i> , <i>Data Bits</i> , <i>Parity</i> , <i>Stop Bits</i> , <i>Flow Control</i> determine the transmission parameters of the interface. They must correspond to the specifications of the printing device (see the operating manual for the printer). |

**Note:** The settings made for the serial interface in the menu *SETUP - GENERAL SETUP* overwrite the settings in the *NT* menu. However, settings in the *Windows NT* menu do not overwrite those of the *SETUP* menu. This means that the settings are only valid as long as the interface is assigned to the operating system.

**4. Selection and installation of the printer driver**

The selection and installation of the printer driver, the assignment to the interface and the setting of most of the printer-specific parameters (eg paper size) is performed under *Windows NT* in the *START - SETTINGS - PRINTER* menu.

**5. Configuration of the connected output device**

The configuration of the connected output device and the assignment to the interface takes place in the *HCOPY DEVICE1/2* menu (see in Chapter 4, the section "Measurement Documentation"). The instrument supports the configuration of up to two output devices (*DEVICE1* and *DEVICE2*), one of which must be activated for printing.

- The parameter *DEVICE* determines which output device is to be used.
- The parameter *PRINT TO FILE* determines if the output is in the form of a file.
- The parameter *ORIENTATION* sets the page format to horizontal or vertical (portrait).

Selecting the type of printer automatically sets the parameters *PRINT TO FILE* and *ORIENTATION* to values which correspond to a standard operating mode with this output device. Other printer-dependent parameters such as *FORMFEED*, *PAPERFEED* etc., can be modified under *Windows NT* in the printer properties window (*START/SETTINGS/PRINTER/SETTINGS/....*).

Table 1-1 shows the standard factory settings for the two output devices.

The factory settings for *DEVICE 1* correspond to output format "WMF" (*Windows Metafile*); printing is performed in a file. WMF is a common format which is used for the import of hardcopies (eg measurement windows) in other *Windows* applications that support this format (eg *WinWord*).

The factory settings for *DEVICE 2* are "Clipboard". In this setting the printout is copied to the *Windows NT* clipboard. Most of *Windows* applications support the clipboard. The clipboard contents can be directly inserted into a document via *EDIT - PASTE*.

Table 1-1 Factory settings for *DEVICE 1* and *DEVICE 2* in the *HCOPY* menu.

Setting	Selection in the configuration table	DEVICE 1 Settings	DEVICE 2 Settings
Output Device	DEVICE/LANGUAGE	WINDOWS METAFILE	CLIPBOARD
Output	PRINT TO FILE	YES	---
Page Orientation	ORIENTATION	---	---

In the following example, a HP DeskJet 660C printer is connected to the LPT interface and configured as *DEVICE2* for hardcopies of the screen contents.

---

**Switch off the ESPI.**

---

**Connect the printer to interface LPT.**

---

**Switch on both ESPI and printer.**

---

**Select the printer driver under Windows NT**

- Press key combination <CTRL> <ESC>  
The Windows NT start menu is displayed.

- In the Start menu press "Setting" and then "Printers".

The printer window is opened.

- Double-click symbol "Add Printer".

The "Add Printer Wizard" window is opened. This window leads through the following printer driver installation.

- Click "My computer" and then "Next".

The available printer ports are displayed.

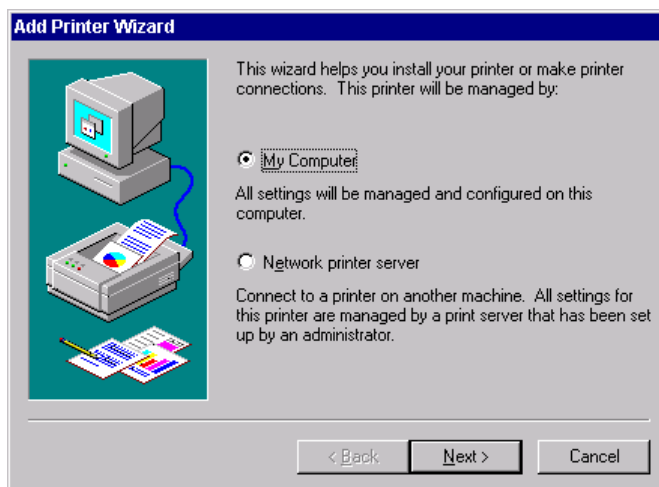

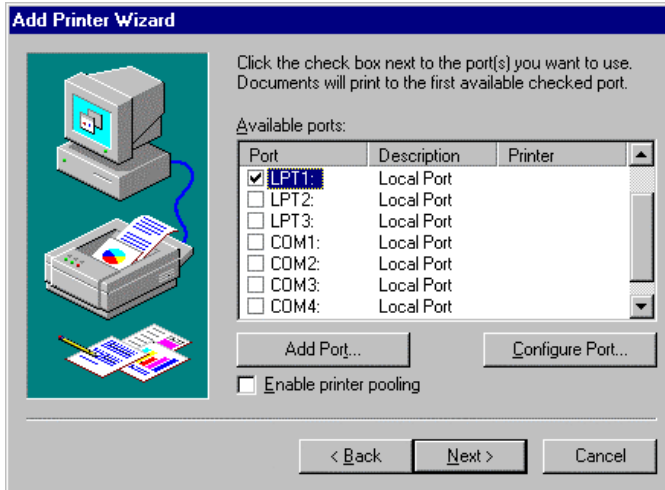

- Select LPT1.
- The selection is marked by a tick.

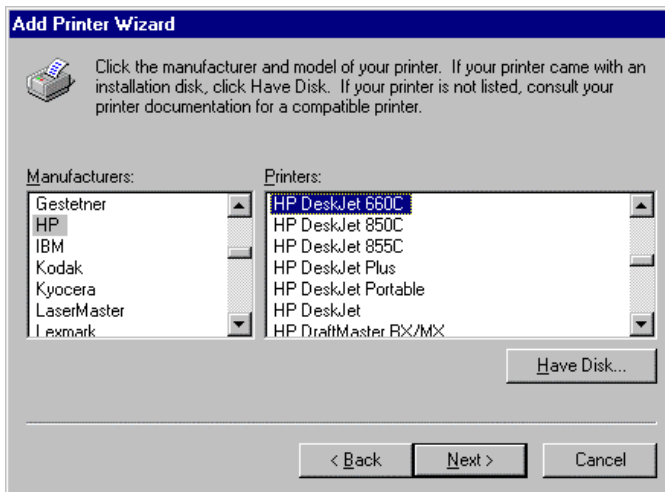

- "Click "Next".
- The available printer drivers are displayed. The left-hand selection table indicates the manufacturers and the right-hand one the available printer drivers.

- Mark "HP" in selection table "Manufacturers" and "HP DeskJet 660C" in selection table "Printers".

**Note:**  
 If the required type of output device is not included in the list, the driver has not yet been installed. In this case click on button "HAVE DISK". A message box requesting to insert a disk with the corresponding printer driver will be displayed. Insert the disk, press OK and select the required printer driver. After installation, Service Pack 5 must be re-installed (see section "Installing Windows NT Software").

- Click "Next".
- The entry field for the printer name is displayed.

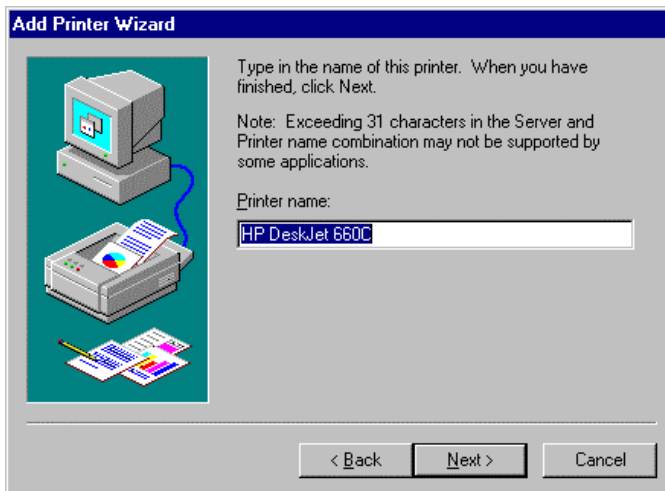

- The printer name can be modified in the entry field "Printer name" (max. 60 characters).

If one or more printers are already installed, a query is displayed in this window to ask if the printer last installed as default printer should be selected for the Windows NT applications (Do you want your Windows-based programs to use this printer as default printer?). The default selection is "No".

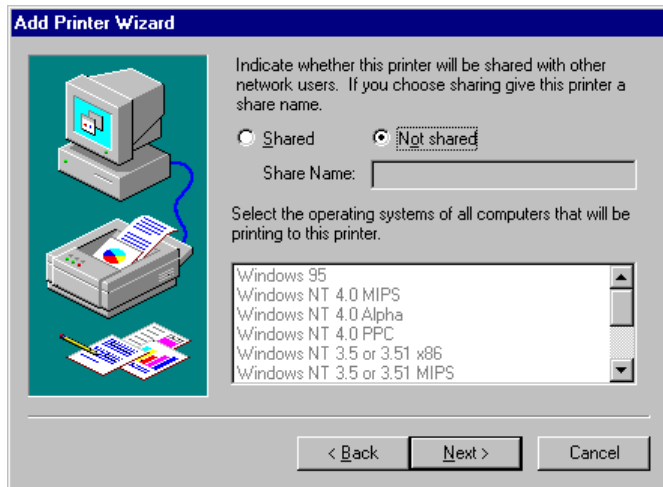

- "Click "Next".

A query is displayed for providing the printer in the network. This query is irrelevant when installing a local printer. The default selection is "Not shared".

- Click "Next".

The window for starting a test page print is displayed. The test page is helpful for checking if the installation was successful.



- Click Yes (recommended)".

- Click "Finish".

A test page is printed if the installation was successful.

If the test page is not printed or not printed completely, the Windows NT online help offers troubleshooting instructions under the topic "Printer Trouble Shooting".

**Note:**

*If a prompt for the printer driver path appears after pressing "Finish", the Service Pack must be re-installed after this printer installation (see Chapter 1, section "Installing Windows NT Software").*

Now the instrument needs to be configured for creating hardcopies of the measurement screen using this printer.

**Configuring HP DeskJet 660C.**

- Click button "R&S Analyzer Interface".

The measurement screen is displayed.

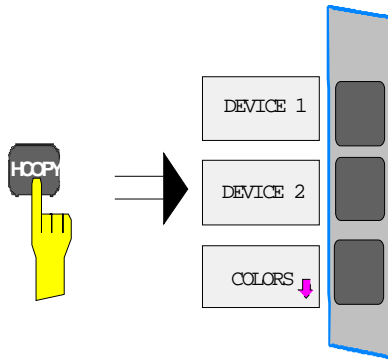

- Press the *HCOPY* key.  
The *HCOPY* menu is opened.

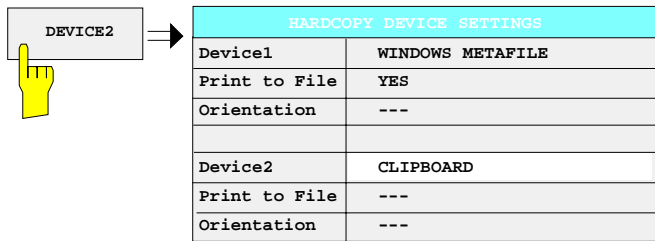

- Press softkey *DEVICE2*.  
*DEVICE 2* is activated as printing device.  
The *HARDCOPY DEVICE SETTINGS*-table is opened and the current settings of the two output devices are displayed. The current selection in line *DEVICE2* is highlighted by the selection bar.

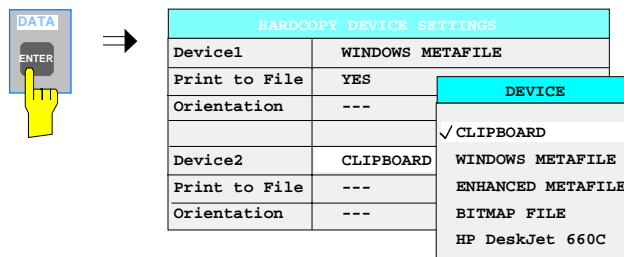

- Press the *ENTER* key.  
The selection box *DEVICE* is displayed on the screen. The current selection is marked by a tick.

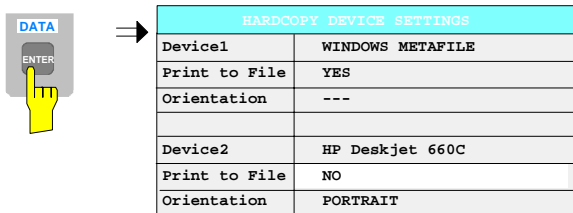

- Press cursor key until the entry *HP DeskJet 660C* is highlighted by the selection bar.

- Press the *ENTER* key.  
The selection box *DEVICE* is closed and *HP DeskJet 660C* is entered in line *DEVICE2*.

**Note:**  
The selection of the printer type automatically sets the parameters *PRINT TO FILE* and *ORIENTATION* to values which correspond to a standard mode with this output device. Other printer-dependent parameters such as *PAPERSIZE*, can be modified under Windows NT in the printer properties window (*START / SETTINGS / PRINTER / SETTINGS*).

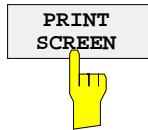

### Start print of measurement results

- Press Softkey *PRINT SCREEN* to start the print job.

## Installation of a Network Printer (with option FSP-B16 only)

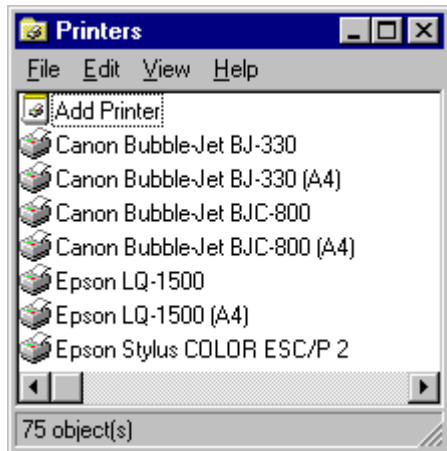

After opening the "Printers" dialog window proceed with the installation as follows:

- Double-click the "Add Printer" line.

The "Add Printer Wizard" window is opened. This window guides the user through the printer driver installation.

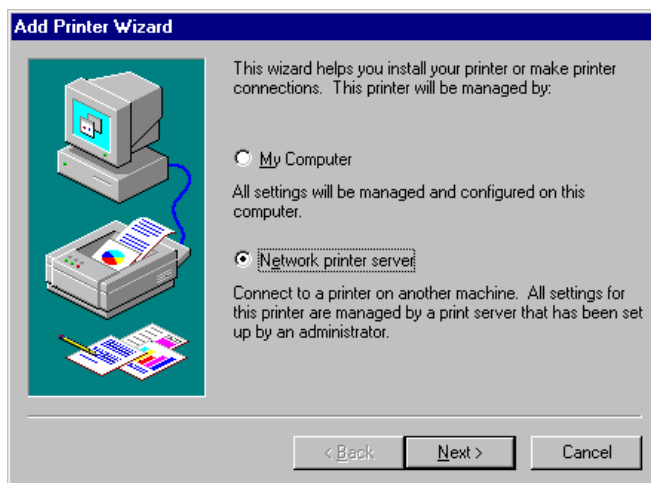

- Click "Network printer server" and then "Next".

A list of selectable printers is displayed.



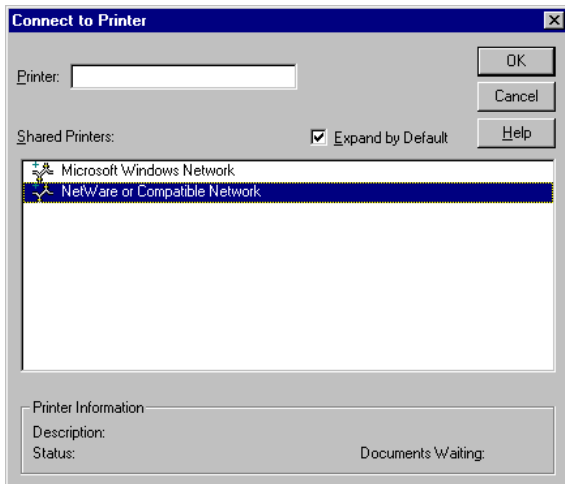

- Mark the desired printer and select it with OK.
- Confirm the following request for the installation of a suitable printer driver with OK.

The list of printer drivers is displayed. The manufacturers are listed in the window at the left, the available printer drivers at the right.

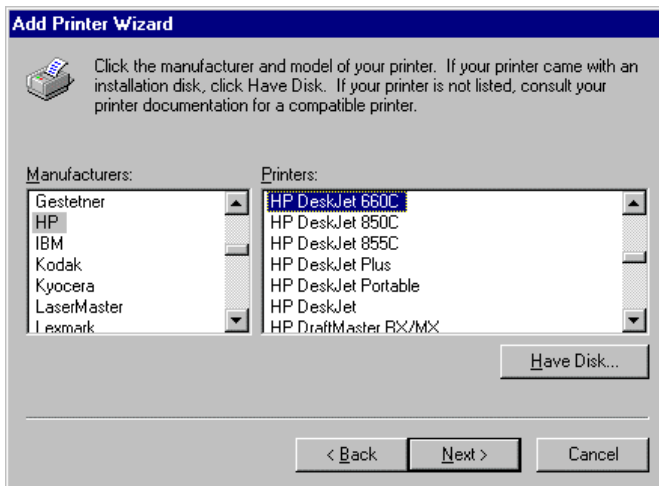

- Select the manufacturer in the "Manufacturers" window and then the printer driver in the "Printers" window.

**Note:**

*If the required type of output device is not included in the list, the driver has not yet been installed. In this case click on button "HAVE DISK". A message box requesting to insert a disk with the corresponding printer driver will be displayed. Insert the disk, press OK and select the required printer driver. After installation, Service Pack 5 must be re-installed (see section "Installing Windows NT Software").*

- Click "Next"

If one or more printers are already installed, a prompt is displayed in this window to ask if the printer last installed as default printer should be selected for the Windows NT applications ("Do you want your Windows-based programs to use this printer as default printer?"). The default selection is "No".

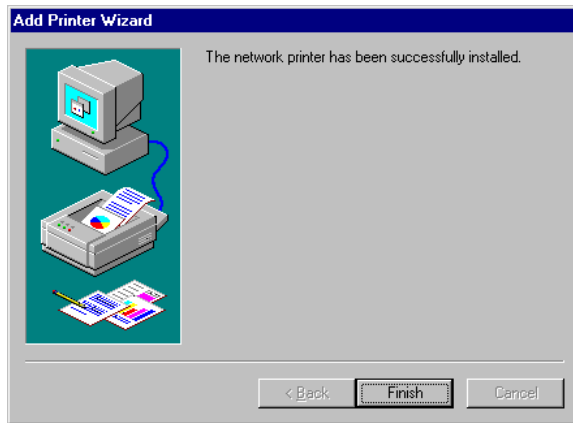

- Start the printer driver installation with "Finish".

**Note:**

If a prompt for the printer driver path appears after pressing "Finish", the Service Pack must be re-installed after this printer installation (see Chapter 1, section "Installing Windows NT Software").

Finally, the instrument has to be configured for printout with this printer using the DEVICE 1 and DEVICE 2 softkeys in the hardcopy menu.

## Installing Windows NT Software

The driver software and the system settings of Windows NT are adapted to the measurement functions of the instrument. Correct operation of the instrument can therefore only be guaranteed if the software and hardware used is authorized or offered by Rohde & Schwarz.

The use of other software or hardware may cause failures in the functions of the ESPI.

The following software was successfully tested for compatibility with the instrument software:

- FS-K3 – Software for Measurement of Noise Figure and Gain
- FS-K4 – Software for Phase Noise Measurement
- Symantec PCAnywhere – Software for remote control via softfront panel
- VNC – Software for remote control via softfront panel
- FileShredder – Software for secure deletion of files on the hard disk
- Symantec Norton AntiVirus – Antivirus protection software

A current list of the software authorized for use on the ESPI can be obtained from your nearest Rohde&Schwarz agency (see list of addresses).

After installing any software of other manufacturers from a disk, it is necessary to re-install Service Pack 5 of Windows NT:

## Reinstallation of Service Pack 5

**Notes:** *If the service pack is not installed, the following error message will be displayed: "At least one service or driver failed during system startup..."*  
***In this case, the network installation is not fully operational. To prevent faults, it is therefore indispensable to reinstall the service pack***

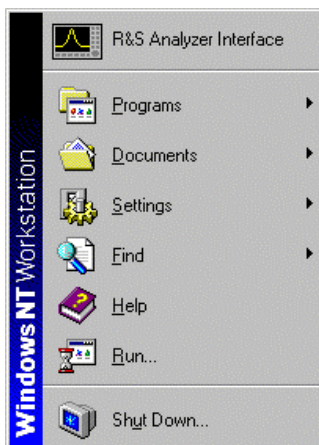

- Open the Windows NT start menu with <CTRL><ESC>.
- Select "RUN".
- Enter the following command:  
`c:\sp\sp5i386 <ENTER>`

The installation of the service pack starts by unzipping the archive file.

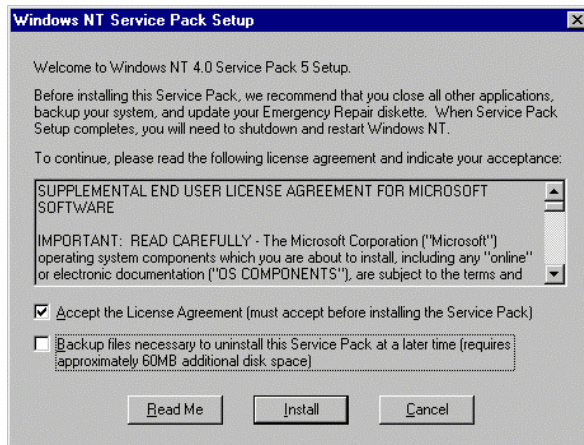

- Confirm the licence agreement by adding a check mark at "Accept the License Agreement..."
- Remove the check mark at "Backup files necessary..." and close the menu with "Install".

The files of the service pack get installed.  
**This takes about 5 min.**

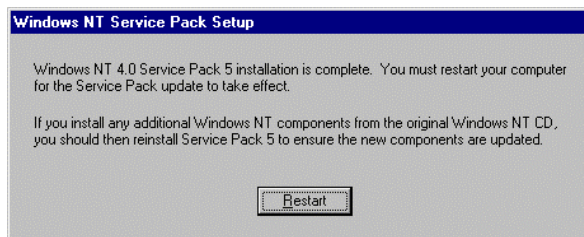

After the installation the prompt for restart of the instrument appears.

- Click button "Restart".

The instrument restarts.



# Contents - Chapter 2 "Getting Started"

## 4 Getting Started

<b>Measurement Example</b> .....	<b>2.1</b>
Example of Level and Frequency Measurement .....	2.2
Measurement .....	2.2
Main Test Receiver Functions .....	2.2
Measurement Sequence - Level and Frequency Measurement .....	2.2



## 2 Getting Started

Chapter 2 provides a fast introduction to operation by guiding the user step by step through a measurement example.

Before starting any measurement with the ESPI, please note the instructions given in chapter 1 for putting the instrument into operation. In chapters 3 you will find detailed information on customizing the instrument and the display.

For a systematic explanation of all menus, functions and parameters and background information refer to the reference part in chapter 4.

### Measurement Example

This section describes a typical and simple measurement task for an EMI test receiver. Each operating step is explained with the aid of ESPI for rapid familiarization of the user without the need to know all the details of the operating functions.

In the introductory example a **standard measurement** of level and frequency is performed with the aid of the SCAN table. This measurement is an overview and precertification measurement to be performed before the final standard-conformal measurement is carried out.

**Note:** *If unknown (RFI) signals are to be measured, it is strongly recommended to provide for at least 10 dB RF attenuation at the RF input in order to protect the input circuit.*

In the following example the test receiver is set to default values in the receiver mode. The default setup is activated by pressing first the *RECEIVER* hotkey and then the *PRESET* key. The main default parameters are listed in the following table.

Table 2-1 Default parameters after preset in receiver mode

Parameter	Setting
Receiver frequency	100 MHz
RF attenuation	Auto
Preamplifier	Off
Detector	AV
Measurement time	100 ms
RES bandwidth	120 kHz
Demodulator	Off
Trigger	Free run



## Example of Level and Frequency Measurement

### Measurement

Measurement and display of RFI signal levels versus frequency is one of the most frequent tasks performed by an EMI test receiver. In the case of unknown signals, *PRESET* values will mostly be used for the measurement. If levels higher than +137 dB $\mu$ V (10 dB RF attenuation) are expected or possible, a power attenuator has to be connected in front of the test receiver input. Very high levels may otherwise damage or destroy the attenuator or input mixer.

### Main Test Receiver Functions

The main functions required for the level and frequency measurement are setting the SCAN table (*START FREQUENCY*, *STOP FREQUENCY*, *STEPSIZE*), selecting the resolution (IF) bandwidth (RES BW), setting the measurement time (MEAS TIME) and selecting the detectors (eg peak or average) and *MARKER* functions required for the analysis.

### Measurement Sequence - Level and Frequency Measurement

In this example the spectrum of the signal present at RF INPUT is recorded in the frequency range 150 kHz to 30 MHz. The scan table and associated parameters are manually set.

The example is generally suitable for all fast pre-compliance measurements required for measuring unknown noise spectra of DUTs in the development stage and for modifying prototypes and can be used as a basis for final tests later on.

The high speed of fully synthesized scans, the frequency and amplitude accuracy and the wide dynamic range of Test Receiver ESPI are of utmost importance and very useful for these measurements.

The following measurement steps are performed:

1. *PRESET* of instrument.
2. Selecting *RECEIVER* mode (*RECEIVER* hotkey).
3. Programming the scan table: stop frequency 30 MHz, 1 scan range
4. Selecting detectors, measurement bandwidth and measurement time
5. Applying the signal (RF input)
6. Starting the scan
7. Level analysis in the frequency domain using *MARKER* function
8. Setting the *SPLIT SCREEN* function
9. Tuning to the receiver frequency using the *TUNE TO MARKER* function
10. From overview to standard-conformal measurement
11. Storing test results, tables and diagrams

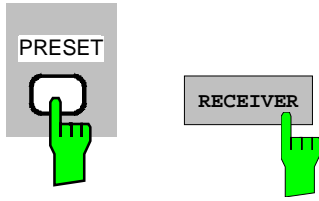

1. **Resetting the instrument and**
2. **Selecting the RECEIVER mode**

➤ Press first the *PRESET* key and then the *RECEIVER* hotkey.

The main receiver menu is opened. The receiver mode is set.

The following screen is displayed:

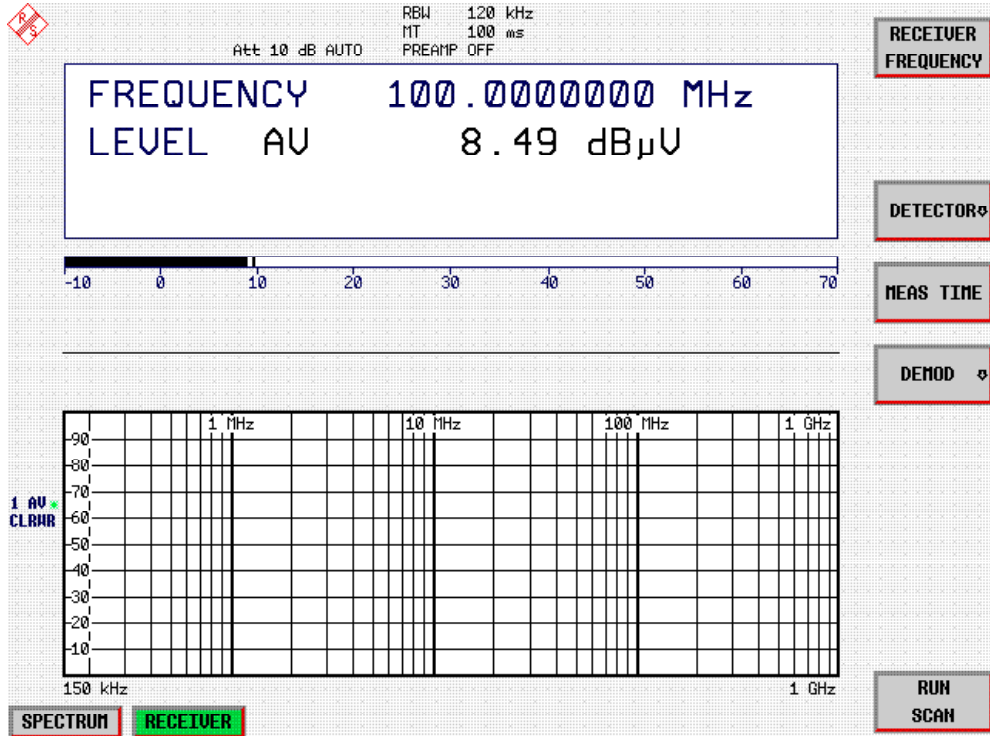
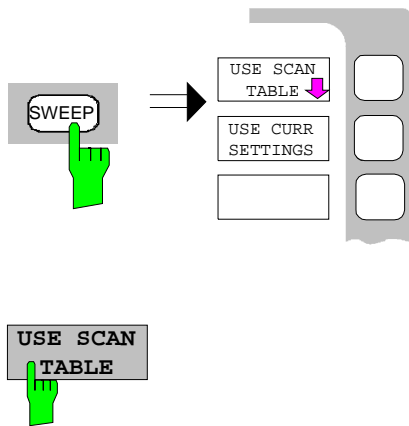

Fig.2-1 Display after selecting the default setup in receiver mode



### 3. Programming a SCAN table

- Press the **SWEEP** key.
- In the **SWEEP** menu press the **USE SCAN TABLE** softkey.

A menu is displayed where the whole display range can be defined and divided into scan subranges.

After **PRESET** a scan range of 150 kHz to 1 GHz is preset on the frequency axis.

Now the stop frequency is set to 30 MHz.

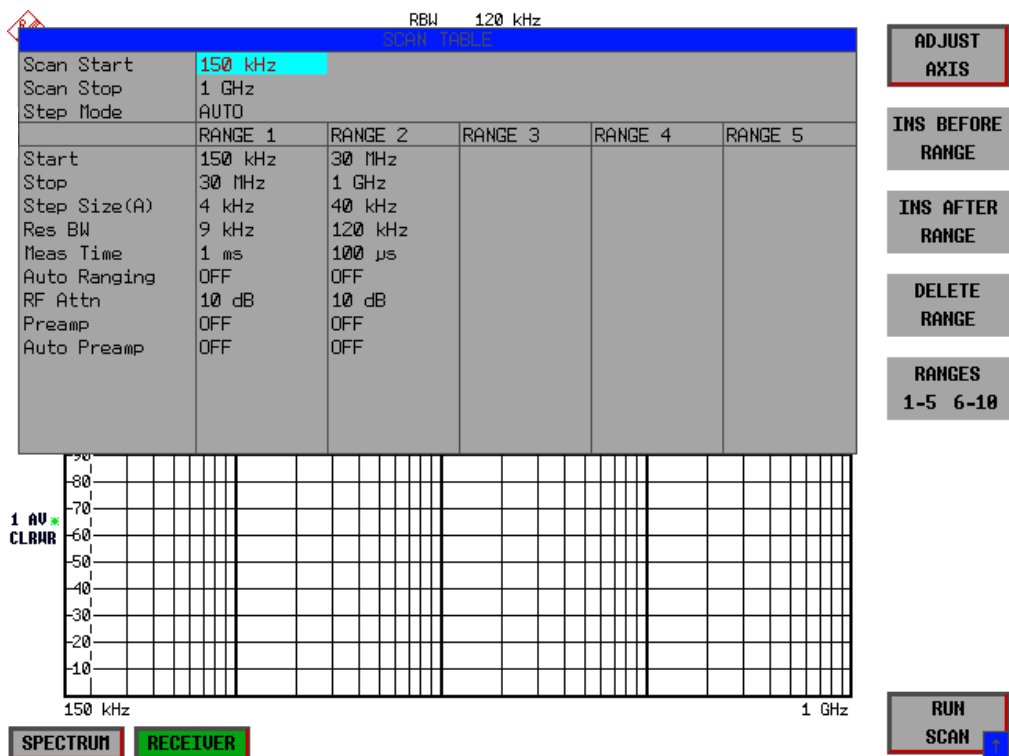
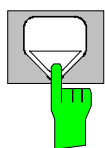
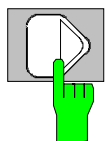

Fig.2-2 Scan range after selecting default setup with PRESET



- Press the **DOWN** cursor in the **DATA VARIATION** field repeatedly until a line in the scan table is marked.



- Press the **RIGHT** cursor key in the **DATA VARIATION** field.

An entry in the **RANGE 2** column is marked.



- Press the *DELETE RANGE* softkey.
- All entries in column *RANGE 2* are cleared.
- The following scan table is now displayed:

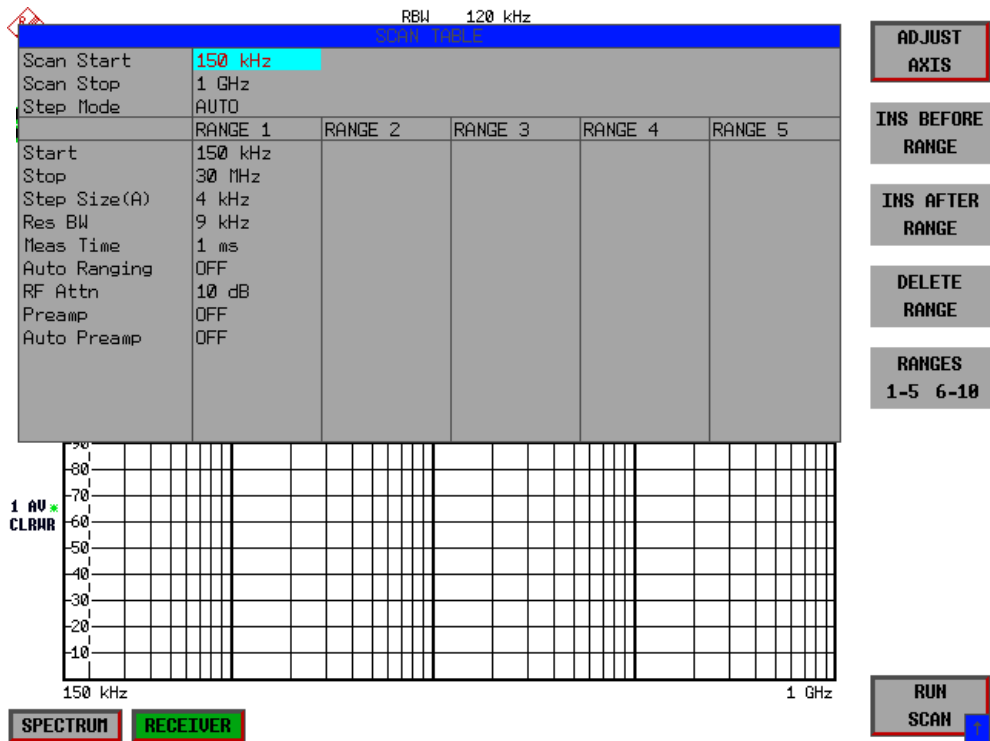
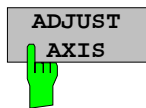
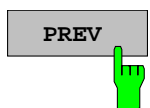

Fig.2-3 Modified SCAN table for preparing a SCAN

After editing the scan subrange, the frequency display has to be adapted to the new settings. The lowest START frequency of SCAN range 1 and the highest STOP frequency of the subsequently defined subranges are used for defining the start and stop frequencies of the graphics display. In the example the limit frequencies of *SCAN RANGE 1* are therefore also the limits of the graphics display.



- Press the *ADJUST AXIS* softkey.
- The respective frequency values in the table are transferred to adapt the display.



- Press the menu change key *PREV*.
- The *USE SCAN TABLE* submenu is closed.

**4. Selecting detectors**

Up to three detectors can be connected in parallel to simultaneously display the amplitude at every frequency as a function of detector weighting. When a parallel detector is selected, the slowest detector (in the sense of a calibrated measurement) determines the speed of the total measurement time required for the scan. The fastest scan is performed when the peak detector is used as the sole detector.

In the example, the peak detector (trace 1) and the average detector (trace 2; default) are used in an overview measurement.

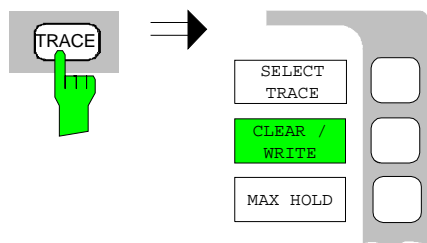

- Press the *TRACE* key.

The *TRACE* menu is opened where the trace can be selected and the detector for the selected trace can be determined.



- Press the *SELECT TRACE* softkey.

A data input field is opened where the number of the trace, here 1, can be entered. The input is confirmed with the *ENTER* key.

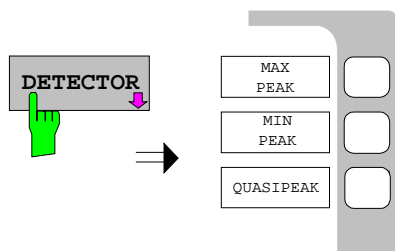

- Press the *DETECTOR* softkey.

The *DETECTOR* menu is opened where different detectors, *MAX PEAK*, *MIN PEAK*, *QUASIPeAK*, *AVERAGE* and *RMS*, can be selected for trace 1.



- Press the *MAX PEAK* softkey.

The peak detector is selected.

- Repeat the settings for trace 2.
- Press the *CLEAR / WRITE* softkey.

In the *DETECTOR* menu select the *AVERAGE* detector.

---

### 5. Applying the signal

- Connect RF cable to the RF input.

---

### 6. Starting the scan

- Press the *SWEEP* key.

The *SWEEP/SCAN* menu is opened.

- Press the *RUN SCAN* softkey.

The measurement with the selected *PEAK* and *AVERAGE* detectors is continuously repeated because the default setting *CONTINUOUS SCAN* remains unchanged.

At the same time the *HOLD SCAN* and *STOP SCAN* softkeys are displayed with the aid of which the scan can be interrupted (*HOLD SCAN*) or aborted (*STOP SCAN*).

In the example the scan should be aborted.

- Press the *STOP SCAN* softkey.

The measurement is aborted.

Peak and average results (see Fig.2-4) should be further analyzed with the aid of the built-in marker functions.

Depending on the DUT, diverse trace forms are obtained. For this reason the diagram below should be regarded as an example.

The scaling of the y-axis can be adjusted in the *AMPT* menu by means of softkey *GRID RANGE LOG MANUAL* if necessary.

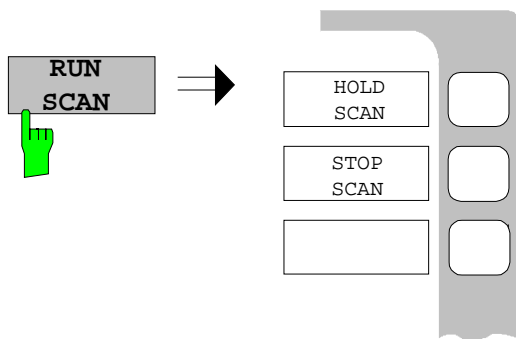

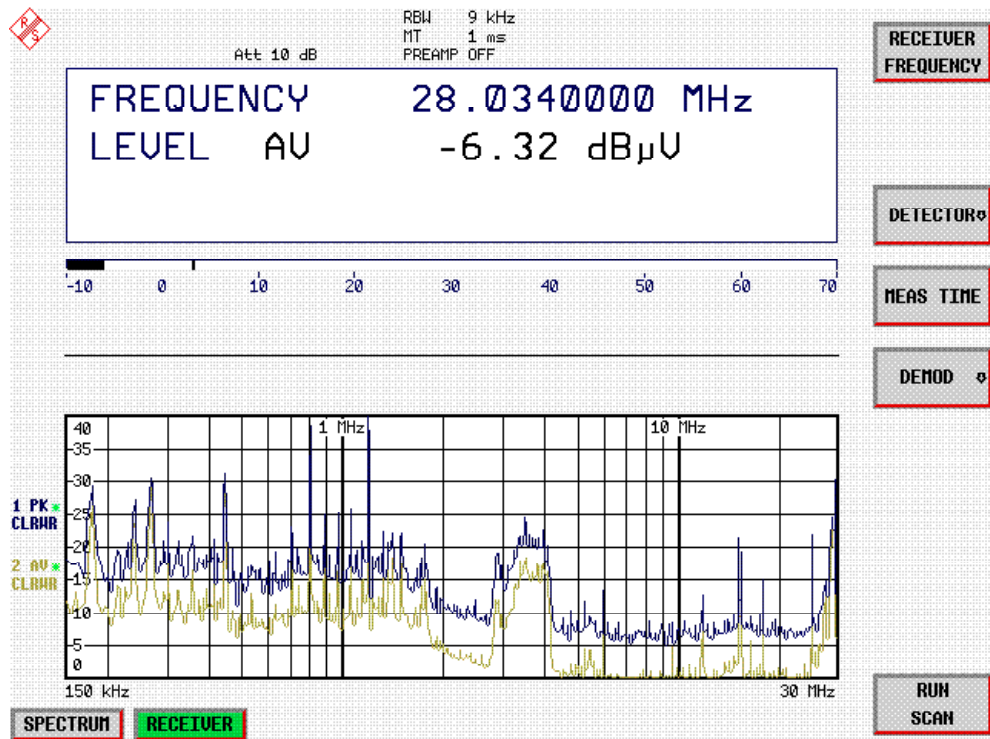

Fig.2-4 Result display of standard pre-compliance measurement using peak/average detector



### 7. Level analysis in frequency domain using MARKER functions

- Press the *MRK* key.

The marker jumps to the largest signal peak shown on the display screen.

**Note:** When the marker is switched on for the first time, it automatically performs the *PEAK SEARCH* function as demonstrated in this example.

If a marker was already active, the *PEAK* softkey in the *MRK->* menu must be pressed in order to set the currently active marker to the displayed signal maximum.

The level and frequency measured by the marker can be read in the marker field at the upper edge of the display screen.

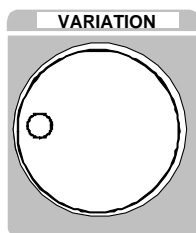

- Move the marker on the trace with the aid of the spinwheel.

The respective level and frequency values are displayed in the marker field.

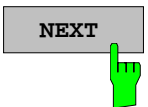
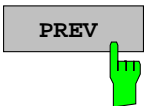
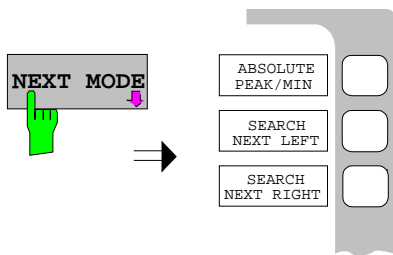
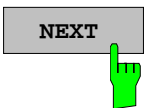
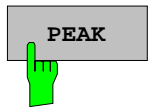
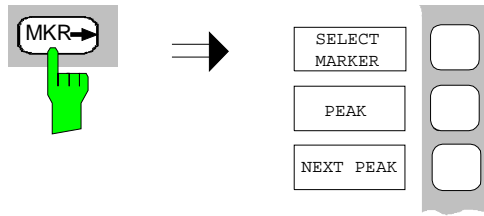

or with  
**PEAK search functions**

➤ Press the *MARKER* → key.  
The *MARKER* → menu is opened.

➤ Press the *PEAK* softkey.  
The marker is positioned at the maximum level in the display.

➤ Press the menu change key *NEXT*.  
The right submenu is opened.

➤ Press the *NEXT MODE* softkey.  
The *NEXT MODE* submenu is opened.

➤ Press the *ABSOLUTE PEAK/MIN* softkey.

➤ Press the menu change key *PREV*.  
The *NEXT MODE* menu is closed.

➤ Press the menu change key *NEXT*.  
The left submenu is opened.

➤ Press the *NEXT PEAK* softkey.  
The marker moves to the next lower level in the spectrum irrespective of whether the frequency is higher or lower than that of the previously measured *PEAK* value.



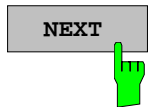

- Press the menu change key *NEXT*.  
The right submenu is opened.

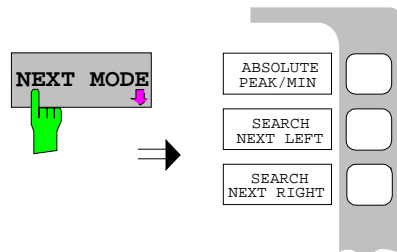

- Press the *NEXT MODE* softkey.  
The *NEXT MODE* submenu is opened.



- Press the *SEARCH NEXT RIGHT* softkey.

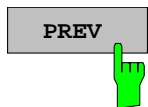

- Press the menu change key *PREV*.  
The *NEXT MODE* menu is closed.

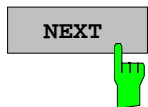

- Press the menu change key *NEXT*.  
The left submenu is opened.



- Press the *NEXT PEAK* softkey.  
The marker is displayed on the next level at a higher frequency (see Fig.2-5).  
The displayed spectrum can be further analyzed with the aid of up to four markers. The markers can be assigned to different traces.

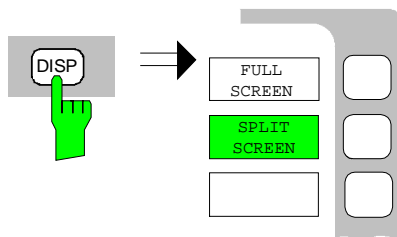

- Press the *DISP* key in the *SYSTEM* field.  
The *SYSTEM DISPLAY* menu is opened.

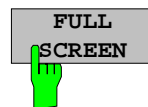

- Press the *FULL SCREEN* softkey.  
One window is displayed on the screen

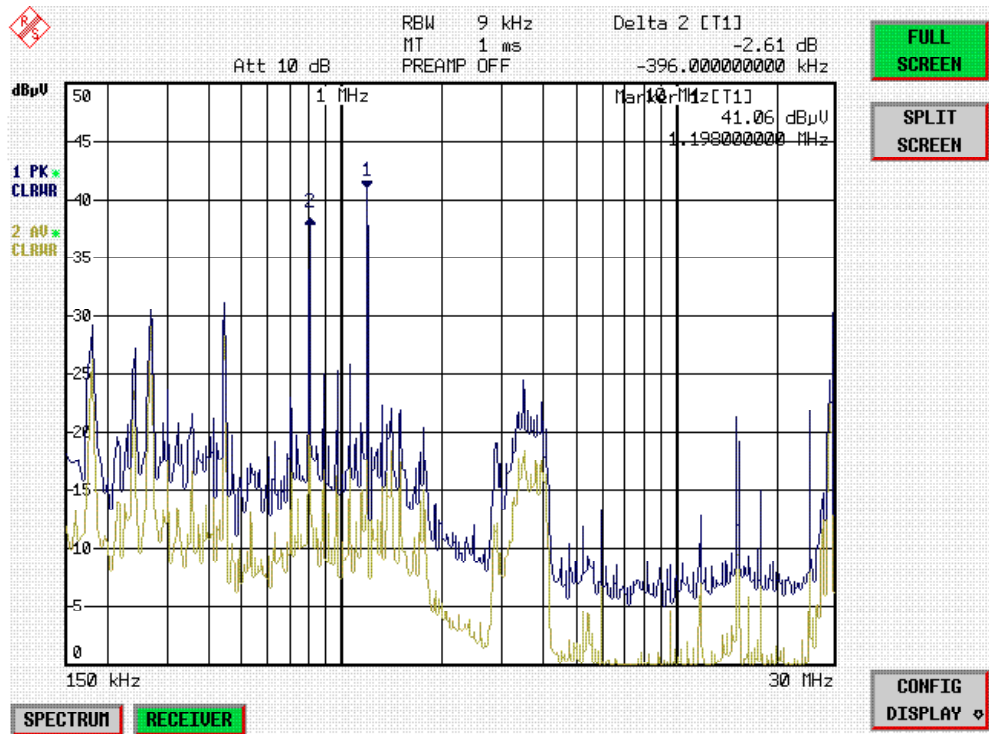
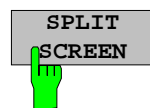
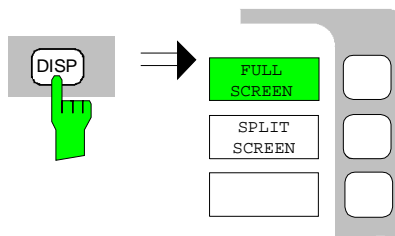

Fig.2-5 Screen display with marker

### 8. Setting the SPLIT SCREEN function

The *SPLIT SCREEN* function simplifies the analysis of measured data, particularly at critical frequencies. In the split-screen mode, the frequency, eg that of the active marker, and the level of the active detectors are displayed in the upper half of the screen numerically and on a bargraph.

- Press the *DISP* key in the *SYSTEM* field.  
The *SYSTEM DISPLAY* menu is opened.



- Press the *SPLIT SCREEN* softkey.  
Two windows are displayed on the screen.

**9. Tuning the receiver frequency and obtaining final test results using the QUASI-PEAK detector**

The currently measured frequency can be rapidly changed eg with the *TUNE TO MARKER* softkey in the *MKR*→ menu. Other or additional detectors can be switched on at this receive frequency and an overview of levels of all active detectors is given. For measurements to standard, the measurement time must first be set to 1 s.



- Press the *MKR* key.

Marker 1 is displayed.

Frequency and level values can be read in the marker field at the top left of the screen.

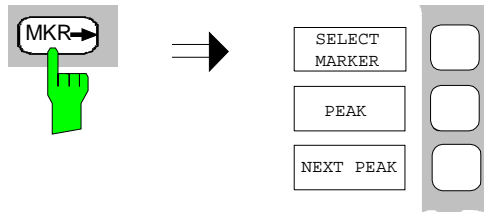

- Press the *MKR*→ key.

The *MARKER* → menu is opened.



- Press the *TUNE TO MARKER* softkey.

The current receive frequency is tuned to the marker frequency.

A measurement time of 1 s must be set for measurements to standard.



- Press the *RECEIVER* hotkey.

The *RECEIVER* menu is opened.

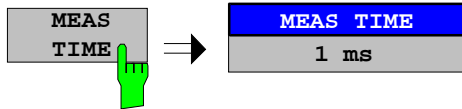

- Press the *MEAS TIME* softkey.

The window with the currently set measurement time is opened (1 ms in the example).

- Enter 1 on the numeric keypad and terminate by pressing s.

The new measurement time is displayed.

The quasi-peak detector should now be switched on in addition.

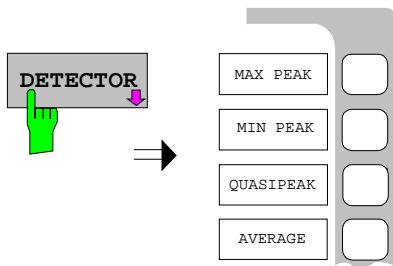

- Press the *DETECTOR* softkey.

The *DETECTOR* menu is opened. The peak and average detectors of the pre-compliance measurement are active.

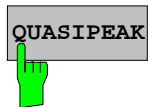

- Press the *QUASI-PEAK* and the *MAX PEAK* softkey.

The *LEVEL* at the current receive frequency is displayed for three detectors numerically and on three bargraphs (see Fig.2-6).

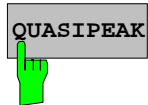

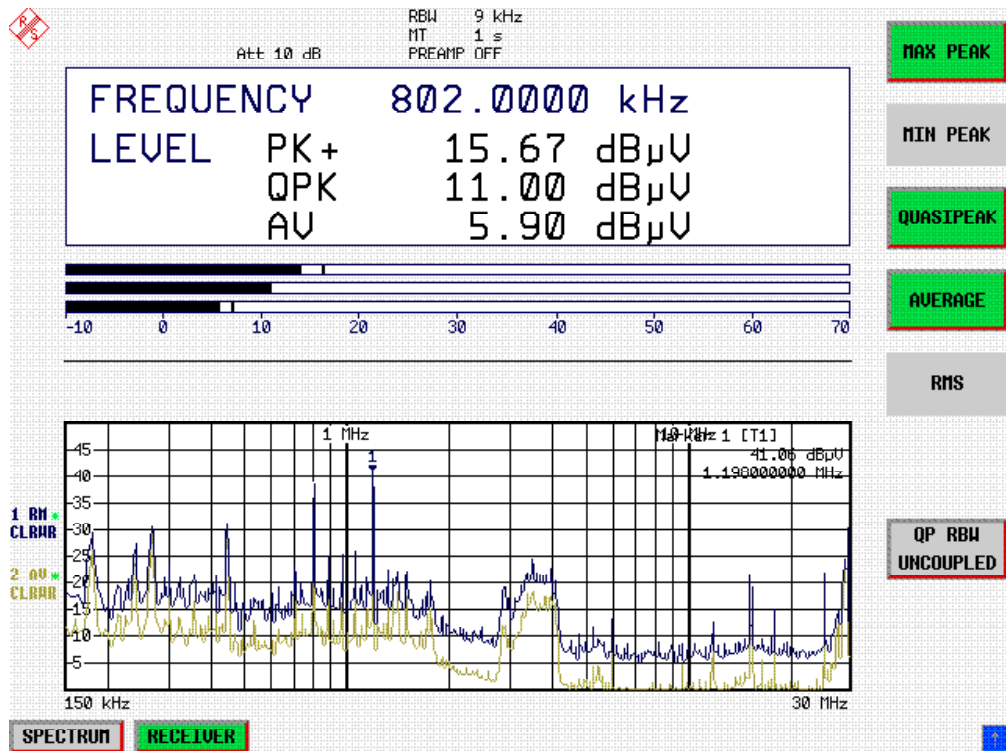

Fig.2-6 Analysis of single frequencies with standard measurement time and several detectors

### 10. From overview to standard-conformal measurement

#### Data reduction and automatic routines for final measurement

The ESPI offers several data reduction methods for interactive or automatic final measurements.

The methods are described in Chapter 4, Section "Data Reduction and Subrange Maxima".

#### Limit lines

A final measurement to standard can be performed when active limit lines are displayed in the diagram during the described analysis and measurements are repeated at all critical frequencies using the standard measurement time and a corresponding detector.

The use and setting of limit lines is described in Chapter 4, Section "Limit Lines - LIMIT Key".

#### Transducer

Care should be taken that the correction values or transducer factors available in tabular form are considered in the measurement result when accessories with frequency-dependent characteristics are used. Several correction tables can be combined to form a transducer set.

The use and entry of transducer tables is described in Chapter 4, Section "Using Transducers".

---

### 11. Storing test results, tables or diagrams on floppy

In the example, test results are stored on a floppy. Measured data are output to a file type \*.wmf for use in other applications.

DEVICE1 and output to a file type \*.wmf is automatically selected with *PRESET*.

The display elements are now selected.

- 
- Press the *HCOPY* key.

The *HCOPY SETTINGS* menu is opened where the output of measurement and device data can be configured and started.

- 
- Insert a floppy into the floppy disk drive.



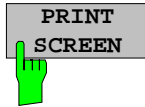

- Press the *PRINT SCREEN* softkey.

The output is started. A window is displayed where the file name and the path must be entered using the built-in auxiliary line editor or the external keyboard, eg

A:\ display.wmf.

- Press the *ENTER* key.

The screen content is stored on the floppy under the specified file name.

During storing the softkeys are blanked. Operation in the menus can be continued when the softkeys are displayed again.

The file can be used in other Windows applications, ie it can be linked.

Fig. 2-7 gives an example of a stored display. In the example, two limit lines are active and four markers positioned in the spectrum.

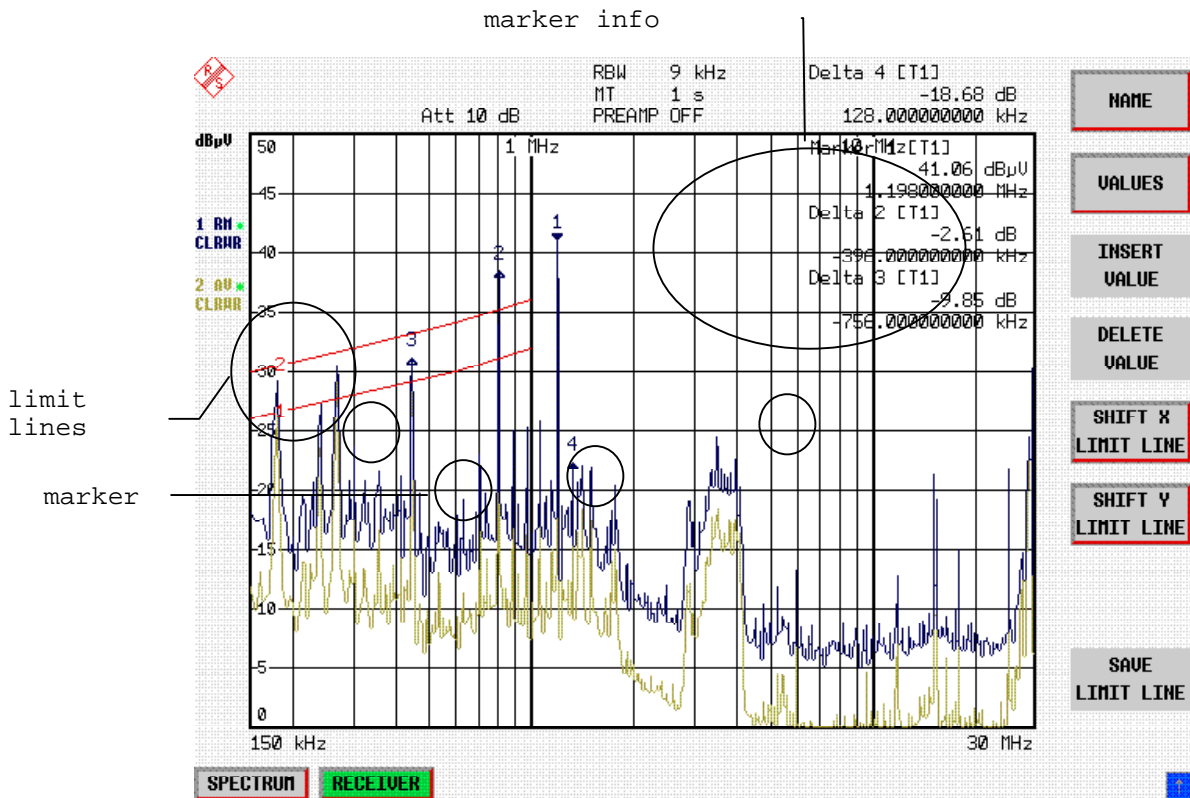

Fig. 2-7 Result display stored in a file in WMF format

**Note:** A detailed description of the file management for complete receiver setups, data records for traces (traces 1-3), limit lines and transducer is given in in Chapter 4, Section "Management of Data Files".

## Contents - Chapter 3 "Manual Operation"

<b>3 Manual Operation .....</b>	<b>3.1</b>
<b>The Screen.....</b>	<b>3.1</b>
Diagram Area .....	3.2
Indications in the Diagram Area .....	3.3
Full Screen .....	3.8
Split Screen .....	3.8
Softkey Area .....	3.9
Hotkey Area .....	3.10
<b>Calling and Changing the Menus .....</b>	<b>3.10</b>
<b>Setting Parameters .....</b>	<b>3.11</b>
Numeric Keypad .....	3.11
Roll-key and Cursor Keys .....	3.12
Selection and Setting of Parameters via Keys or Softkeys.....	3.13
Editing of Numeric Parameters.....	3.16
Entry of Alphanumeric Parameter .....	3.19
Editing with External Keyboard.....	3.19
Editing with Help Line Editor.....	3.20
Selection and Setting of Parameters via Tables.....	3.21
<b>Menu Overview .....</b>	<b>3.24</b>
FREQ Key.....	3.24
SPAN Key.....	3.25
AMPT Key.....	3.26
MKR Key.....	3.27
MKR-> Key .....	3.28
MKR FCTN Key .....	3.30
BW Key.....	3.31
SWEEP Key.....	3.32
MEAS Key.....	3.33
TRIG Key.....	3.35
TRACE Key .....	3.36
LINES Key .....	3.37
DISP Key .....	3.38
FILE Key.....	3.39
CAL Key.....	3.40
SETUP Key.....	3.41
HCOPY Key.....	3.43
Hotkey Menu.....	3.44
LOCAL Menu.....	3.44
<b>Menu Overview RECEIVER Hotkey .....</b>	<b>3.45</b>
<b>Menu Overview Network Mode.....</b>	<b>3.46</b>
<b>Menu Overview Option Ext. Generator Control.....</b>	<b>3.47</b>





### 3 Manual Operation

Chapter 3 provides an overview of the operating concept and the basic steps of manual operation of the ESPI. This includes a description of the screen, of the control of menus and of the setting of parameters. An overview of the menus will be listed at the end of this chapter.

The functions of the menus are described in detail in Chapter 4. Chapter 2 contains a short introduction on step-by-step simple measurements. The remote control of the instrument is described in Chapters 5, 6 and 7.

The operation of the receiver is menu-controlled via keys, hotkeys and softkeys. The setting of the instrument and test parameters in the menu is made either directly via softkeys or by entry of values in entry fields and by selection in tables. The operating mode and the screen mode is selected via the hotkeys.

If required, data entry windows and tables are superimposed on the screen.

### The Screen

The screen informs continuously on the results and parameters of the selected measuring functions. It shows the assignment of the softkeys and menus, which are required for setting the measuring parameters. The display of test results, the softkey labeling and the type of menu depend on the selected measuring function.

The screen is subdivided into three areas:

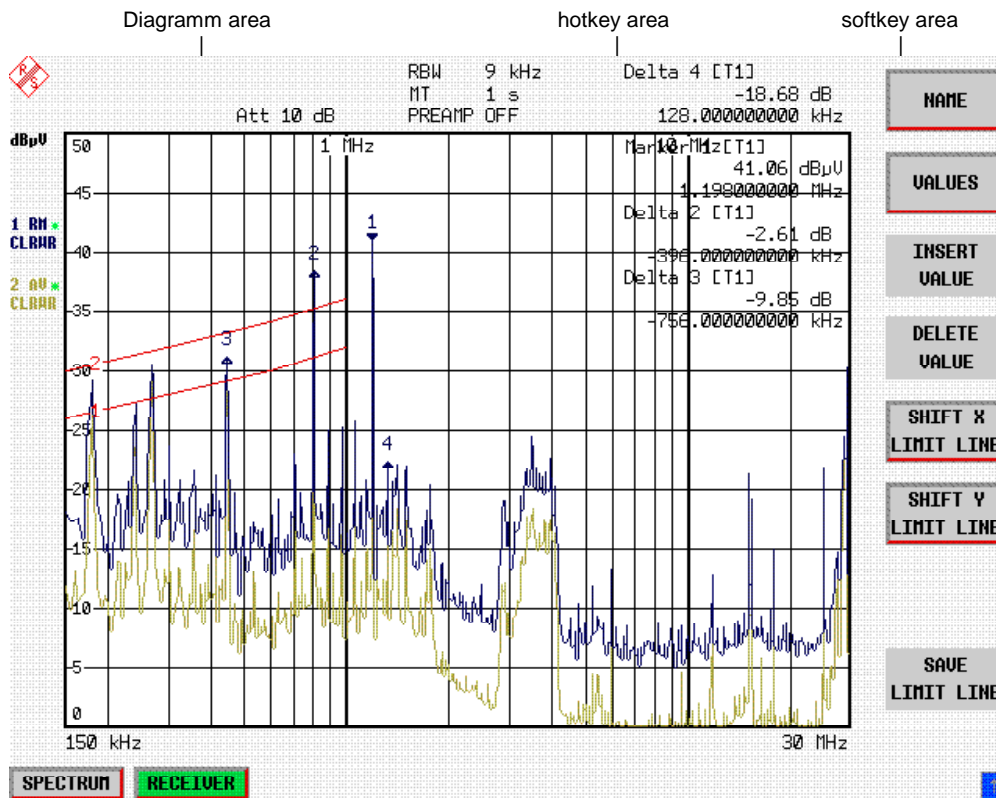

Fig. 3-1 Subdivision of screen

- Diagram area** This area contains the measuring diagrams and other measured-value information as well as the parameters and status information which are important for analysis of the results. In addition, message fields, entry windows and tables may be shown in this area.
- Softkey area** This area contains the instrument functions which can be selected via the softkeys. The softkey area is not superimposed by other graphics.
- Hotkey area** This area contains the available operating modes and screen modes. The hotkey area is not superimposed by other graphics.

### Diagram Area

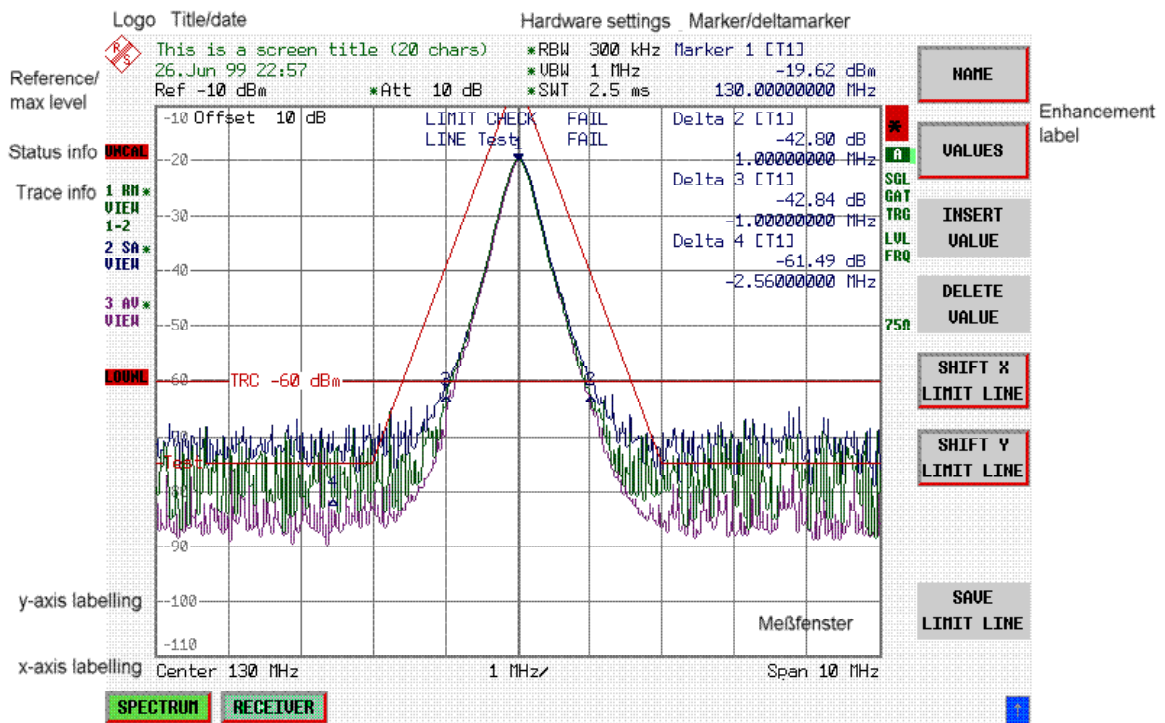

Fig. 3-2 Subdivision of the ESPI screen in analyzer mode (without measuring diagram)

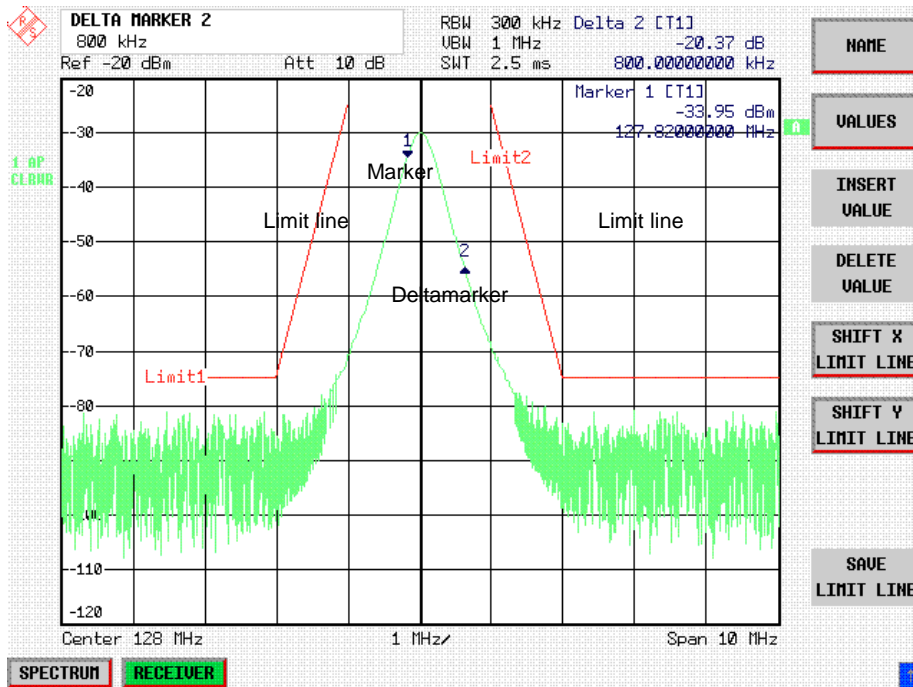

Fig.3-3 Measuring diagram

### Indications in the Diagram Area

The following graphic elements are displayed in the diagram area:

**General indications**                      Indication of the logo

**Logo**

**Screen title**                                Indication of selected screen title

**Date / time**                                Indication of date and time

### Hardware settings

#### Receiver mode

- RBW                      Indication of the set IF bandwidth.
- Att                      Indication of the set RF attenuation.
- MT                      Indication of the set measurement time
- PREAMP                Indication of preamplifier status.

**Analyzer mode**

Ref	Indication of the reference level
Offset	Indication of the offset of reference level.
Att	Indication of the set RF attenuation.
RBW	Indication of the set resolution bandwidth. If the bandwidth does not correspond to the value of the automatic coupling, a green asterisk "*" is prefixed to the field.
VBW	Indication of the set video bandwidth. If the bandwidth does not correspond to the value of the automatic coupling, a green asterisk "*" is prefixed to the field.
SWT	Indication of the set sweep time. If the sweep time does not correspond to the value of the automatic coupling an asterisk "*" is prefixed to the field. The colour of the asterisk turns red as soon as the sweep time falls below the value of the automatic coupling.

**Marker/deltamarker**

This label displays the position of the last selected marker or deltamarker in the x and y-directions and the marker/deltamarker index. The square brackets contain the curve which the marker is assigned to and the active measuring function of the marker indicated. The measuring function of the markers in the second field is indicated by the following abbreviations:

FXD	reference fixed active
PHN	phase noise measurement active
CNT	frequency counter active
TRK	signal track active
NOI	noise measurement active
MOD	measurement of AM modulation depth active
TOI	TOI measurement active (3 <sup>rd</sup> order intercept)

**Limit check**

Indication of the result of the limit check.

**X-axis labelling**

Display of the x-scaling.

{10 MHz/DIV\_\_\_\_\_}

The distance between two grid lines is displayed in this label.

{Center 1.2345678901234 GHz}

The set center frequency or start frequency is displayed in this label depending on whether the keys FREQ/SPAN or the softkeys START/STOP were last pressed.

{Start 1.2345678901234 GHz}

If span = 0 Hz, the center frequency is always displayed.

{Span 1.2345678901234 GHz}

The set frequency range (SPAN) or the stop frequency is displayed, depending on whether the keys FREQ/SPAN or the softkeys START/STOP were last pressed.

{Stop 1.2345678901234 GHz}

If span = 0 Hz, the trigger moment (*PRETRIGGER*) is displayed.

{Trigger 1.234 ms}

**Status information** The status information on the left side of the diagram hint at irregularity (e.g. UNCAL)

**UNCAL** "UNCAL" is indicated under the following circumstances:

- correction data are switched off (menu CAL, CAL CORR OFF).  
switch on CAL CORR ON or PRESET
- no valid correction data. This may occur after a cold start of the instrument following a firmware update.  
record correction data

**OVLD / IFOVL** OVLD is indicated when the input mixer is overloaded.  
Increase input attenuation

IFOVL is indicated when overload occurs in the IF signal path after the input mixer.  
Increase input attenuation

**MSG / LOUNL** MSG is indicated if a failure has occurred which impair correct measurement. The exact error message can be queried in the menu *SETUP SERVICE INFO*. The display disappears after the cause for the error has been eliminated.

LOUNL is indicated when an error occurs in the frequency processing of the instrument.

**OVEN** OVEN is indicated when the crystal oscillator (option FSP-B4) has not yet reached its operating temperature. This indication vanishes after a few minutes after switch on.

**Trace info:** Every active measurement curve (trace ≠ BLANK) is allocated a trace info of two or three lines at the left of the diagram. The trace info has the same colour as the measurement curve.

<n> <detector> <\*>  
<mode>  
<trace math>

n = trace number (1 ... 3)

detector = selected detector

**AP:** AUTOPEAK detector  
**PK:** MAX PEAK detector  
**MI:** MIN PEAK detector  
**SA:** SAMPLE detector  
**AV:** AVERAGE detector  
**RM:** RMS detector  
**QP:** QUASPEAK detector

\* = indicates that the selected detector does not correspond to that of the automatic coupling.

mode = indication of sweep mode

**CLRWR:** CLEAR/WRITE  
**MAXH:** MAX HOLD  
**MINH:** MIN HOLD  
**AVG:** AVERAGE  
**VIEW:** VIEW

Trace math = trace math active

**1 - 2** trace 1 - trace 2  
**1 - 3:** trace 1 - trace 3

Example:

1 PK \*  
CLRWR  
1-2

**Instrument settings**  
(Enhancement Labels)

Indication of user instrument settings which influence the measuring result and which are not immediately obvious when viewing the measured values.

- \* The current instrument setting does not correspond to the one which applied when one of the displayed curves had been stored. This occurs under the following circumstances:
  - The instrument setting is modified while a measurement is being performed.
  - The instrument setting is modified in SINGLE SWEEP mode subsequent to the end of the sweep and no new sweep is started.
  - The instrument setting is modified after setting the trace to VIEW.

The display is retained until the cause is eliminated by the user. I.e., either a new sweep is started (SINGLE SWEEP mode), or the trace of interest is switched to BLANK.

<b>A / B</b>	Identification for screen A / B. When screen A / B is activated for the entry of test parameters, this label is highlighted.
<b>SGL</b>	The sweep/scan is set to SINGLE SWEEP or SINGLE SCAN
<b>GAT</b>	The frequency sweep is controlled via the <i>EXT TRIG/GATE</i> input of the instrument.
<b>TRG</b>	The instrument is not triggered in <i>FREE RUN</i> mode.
<b>LVL</b>	A level offset $\neq 0$ dB has been set.
<b>FRQ</b>	A frequency offset $\neq 0$ Hz has been set.
<b>PRN</b>	A printer output is active.
<b>75 <math>\Omega</math></b>	The input impedance of the instrument is set to 75 $\Omega$ .
<b>EXT</b>	The instrument is configured for operation with external reference
<b>PA</b>	The RF preamplification is switched on (option ESPI-B2).
<b>PS</b>	The HF preselection is switched on.
<b>TDF</b>	A antenna correction factor ( <i>TRANSDUCER FACTOR</i> ) is switched on.
<b>TDS</b>	A set of antenna correction factors ( <i>TRANSDUCER SETS</i> ) is switched on.

**Entry fields:****Entry window**

The data entry window is superimposed in the left upper corner of the diagram area, if required. It covers the display of the title and the time. The field is used to enter numeric or alphanumeric device parameters.

**Tables**

The tables are superimposed in the diagram area, if required. They are used for indication and configuration of the instrument parameters..

**Message windows:****Message field**

Message fields provide notes on measurements, e.g. results of the limit check (PASS/FAIL). These notes are no error messages, which are indicated as system messages.

They can be masked out by pressing the *ESC* key.

**System messages**

System messages indicate warnings and error messages.

**Message without action field:**

These system messages contain only arbitrary information. They hint at events which are of interest for the user but do not affect the measurement or functioning of the instrument.

They are deleted either automatically after a predefined time has passed (3 seconds) or upon any keystroke or mouse click.

**Message with action field:**

These system messages require a decision to be taken by the user. They are not deleted until any action has been selected. Deletion of the message initiates the action selected and appropriate measures to be taken. The action field consists of one (OK), two (OK/CANCEL) or three (arbitrary) buttons.

The user may select one of the buttons using the cursor keys and initiate the associated action by means of the unit keys. The *ESC* key is used to acknowledge the message without releasing any action.

**Traces:****1 to 3**

Up to 3 traces in each measurement diagram can be displayed simultaneously.

**Limit lines**

Limit lines are used to mark level curves or spectral distributions which must not be exceeded or dropped below.

The ESPI provides two display modes:

- Full Screen: 1 window, the measurement is performed in the active diagram.
- Split Screen: 2 windows, the measurements are performed in both diagrams.



### Full Screen

In the full-screen mode, the settings and measurements are performed in the active visible window. All indications on the screen refer to this window. The designation (SCREEN A or SCREEN B) is inserted as enhancement label A or B on the right diagram margin.

Switching between the windows is by means of *SCREEN A/B* hotkey. The current measurement is terminated when its window is blanked out.

Switching from split-screen to full-screen mode is performed in menu *DISP*.

### Split Screen

In Split Screen mode, the screen is divided into two halves.

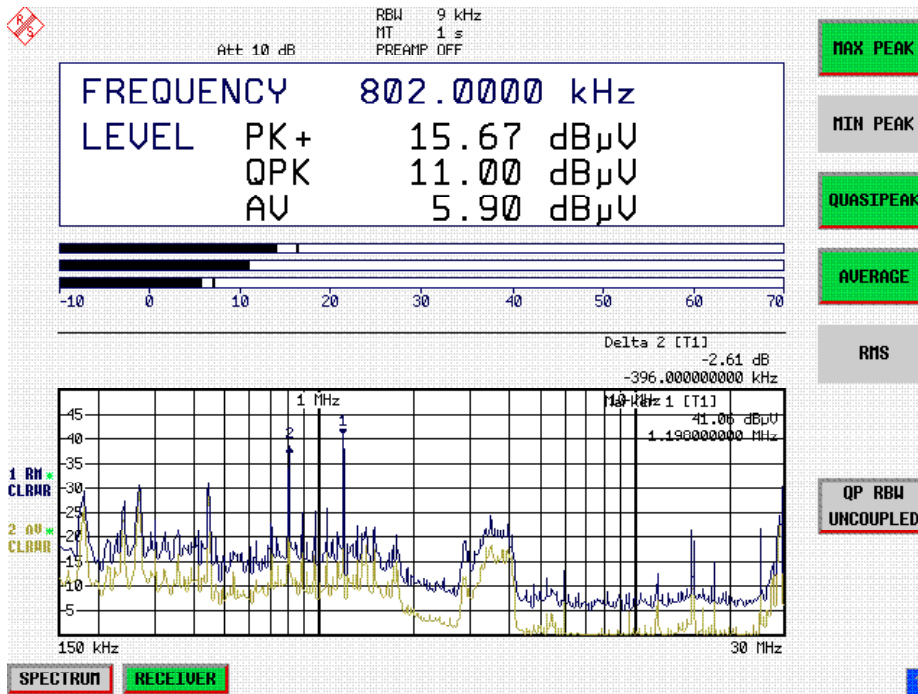

Fig.3-4 Subdivision of the screen in Split Screen mode

In the receiver mode, the screen is divided up according to fixed configurations.

Table 3-1 Default assignment of traces to windows with split screen in the receiver mode

upper (screen A)	Indication of level and frequency
lower (screen B)	Scan spectrum

In analyzer mode, the upper half is assigned Screen A, the lower one Screen B. The settings for measurement can be selected independently for both screens. E.g., a spectrum may be displayed in Screen A and a time amplitude in the time range is displayed in Screen B.

The indications which are valid only for one window appear in the margin of the associated diagram. Indications which are valid for the two windows are displayed between the diagrams.

The window for entry of the measuring parameters or the marker operation is selected using the *SCREEN A/B* hotkey. The measurements are simultaneously performed in the two windows irrespective of the currently active one.

Switching from full-screen to split-screen mode is performed in menu *DISP*.

## Softkey Area

The softkeys are assigned to the nine keys on the right side of the display. The setup of the softkey area is independent of the operating mode. It consists of the following graphic elements:

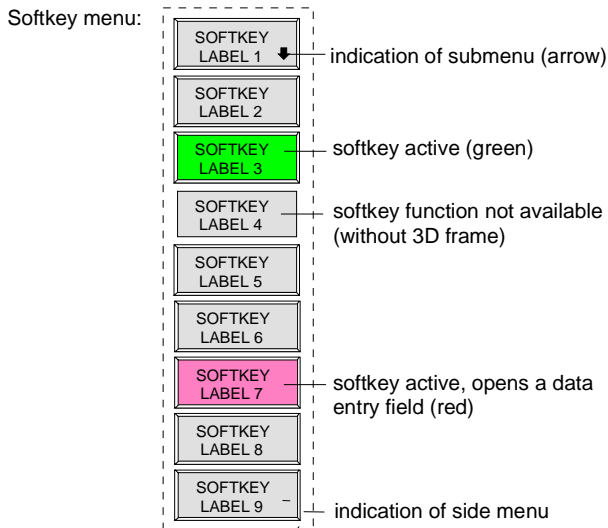

Fig.3-5 Setup of the softkey area

The softkeys have different functions depending on the instrument state. Therefore, their labeling can be varied. The labeling of all softkeys which call a submenu includes a arrow. The function and current state of the softkeys is indicated in the label by different texts and colors. The color assignment is factory-set as follows:

Table 3-3 Factory-set color assignment of soft keys

Softkey color	Meaning
gray	Softkey switched off
green	Softkey switched on
red	Softkey switched on and data entry active

These colors can be changed by the user as desired in the *DISP - CONFIG DISPLAY* menu.

A softkey is switched on or off by pressing the respective hardkey (see following section "Setting the Parameters").

Softkeys are masked out, too, if the functionality which they represent is not available. A distinction has to be made between two cases:

- If an instrument function depends on an option, and if this option is not fitted, the associated softkey is masked out,.
- If the instrument function is not available temporarily due to specific settings, the softkey is displayed without the 3D frame.

The label "➡" on the right lower corner of the softkey area indicates that a side menu is available. The side menu is called by pressing the *NEXT* key.

## Hotkey Area

Hotkeys are allocated to the eight keys on the bottom margin of the screen. They change between modes and the active diagrams.

The menu only shows the hotkeys which are actually used:

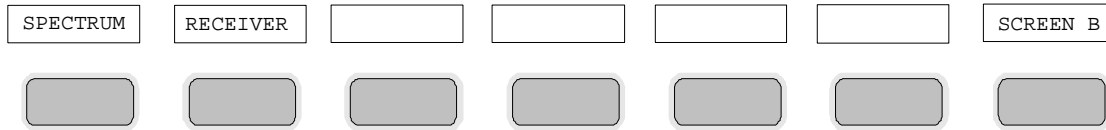

A keystroke activates the associated hotkey. An activated hotkey changes its frame:

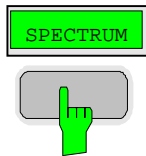

## Calling and Changing the Menus

The operation of the receiver is menu-controlled via keys and softkeys. Various softkey menus are displayed depending on the instrument status. The individual menus constitute the so-called menu tree. The top menu (the root of the menu tree) is always called by means of a keystroke. Arrows at the lower edge of the softkey area indicate whether a supplementary menu can be entered or not.

Softkeys with an arrow allow for branching into further menus (so-called submenus): The field ">" at the lower right side of the softkey area indicates that this menu has a side menu.

The menu change keys on the front panel below the softkey area allow for switching between the main menu and the side menus and submenus.

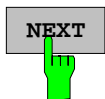

The *NEXT* key calls the side menu.



The *PREVIOUS* key returns to the next higher menu.

Several menus provide for automatic change, i.e., return to the next higher menu is caused automatically after pressing a softkey.

Selection of a submenu is always effected via a softkey.

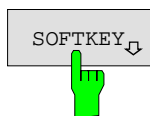

The labeling of all softkeys which call a submenu includes an arrow.

## Setting Parameters

Parameters are set either by simple selection (selection parameters) or by (alpha)numeric entries in data entry windows or tables.

The numeric keypad on the front panel, an external keyboard (optional), a roll-key and the cursor keys are provided for the entry of instrument parameters in an entry window or in a table.

The external keyboard is optional. If it is not fitted, the help line editor is called automatically for entry of alphanumeric parameters. The help line editor provides for selection of individual letters and a number of special characters which are copied into the actual entry window.

### Numeric Keypad



The numeric keypad is provided for entry of numeric parameters. It contains the following keys:

- Number keys 0 to 9
- Decimal point  
Inserts a decimal point "." at the cursor position.
- Sign key  
Changes the sign of the mantissa or exponent of a numeric parameter.  
A "-" is inserted at the cursor position in case of an alphanumeric parameter.
- Unit keys (*GHz/-dBm*, *MHz/dBm*, *kHz/dB* and *Hz/dB*)
  - Provide the numeric value entered with the selected unit and terminate the entry.  
The unit keys are all assigned the value "1" for dimensionless quantities or for level entries (e.g., in dB). The unit keys thus assume the function of an *ENTER* key. The same applies for an alphanumeric entry.
  - Open and close the selection windows of tables.
- *BACK* key
  - Deletes the character left to the cursor with numeric entry.
  - Allows for toggling between the current and the previous values subsequent or prior to entry (*UNDO* function).
- *ESC/CANCEL* key
  - Aborts the entry before it has been terminated. The previous value is restored.
  - Closes the entry field after termination of input.
  - Closes system messages.
- *ENTER* key
  - Terminates the input of dimensionless quantities. The new value is set.

**Note:** The *ENTER* keys assumes the function of the *Hz* key for frequency input, and the function of the  $\mu$ s(*kHz*) key for time input.

## Roll-key and Cursor Keys

The roll-key and the cursor keys are arranged besides the numeric keypad.

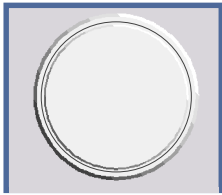

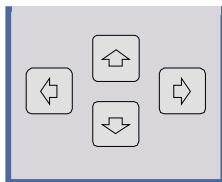

The roll-key has various functions:

- With numeric entry, the instrument parameter is incremented (turning clockwise) or decremented (turning counterclockwise) at a defined step size.
- In tables, the roll-key can be used to shift the cursor horizontally or vertically when no entry window is open. The direction (horizontal/ vertical) is switched over using the cursor keys.
- The roll-key is used with the help-line editor to select the individual letters.
- It can be used to shift markers, display lines, limit lines etc.
- Pressing the roll-key terminates the input of parameters.



In tables, the cursor keys are used to shift the cursor between the lines and columns of the table.

The keys  and  are used to shift the cursor inside the entry window to reach a particular position in the string.

The keys  and 

- increase or decrease the value of a parameter for numeric input .
- switch between editing line and help line editor for alphanumeric input.

## Selection and Setting of Parameters via Keys or Softkeys

The selection of parameters and their settings is effected by means of a key, a softkey or in a table depending on the hierarchical level of the menu they are assigned to. Selection and setting of parameters in tables is described in section "Selection and Setting of Parameters in Tables".

### Selection via key

Most keys of the receiver are used to enter menus where the selection and the settings are made. Few settings can be made directly by means of a keystroke, only.

Example: Call up of preset settings

- Press *PRESET* key

The receiver is brought into a predefined initial state.



### Selection via softkey

In most cases the selection is made by pressing the respective softkey. There are various alternatives of making the selection:

1. The softkey is active or inactive.

Example: Switching on/off the frequency counter

- Press *MKR* key.
- Press *SIGNAL COUNT* softkey.

Each time the softkey is pressed, the marker info list is switched on or off. If the softkey is active (= marker info list on), it is illuminated.

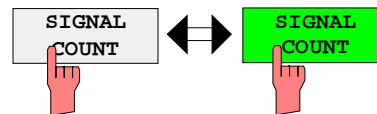

2. The softkey acts like a toggle switch, each pressing changes the active selection.

Example: Selection of the reference (internal or external)

- Press *SETUP* key.
- Press *GENERAL SETUP* softkey, the *GENERAL SETUP* submenu is opened.
- Press *REFERENCE INT/EXT* softkey.

With each pressing, the checkmark on the softkey changes from INT (internal reference) to EXT (external reference) and vice versa. When in the active setting the softkey menu item is illuminated.

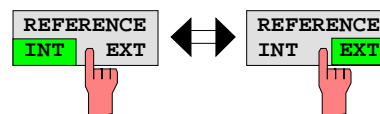

3. Various softkeys act like selection switches. Only one softkey may be active at a time.

Example: sweep setting

- Press *SWEEP* key.
- Press *CONTINUOUS SWEEP* softkey.

The continuous sweep is thus set. The *CONTINUOUS SWEEP* softkey is colored (factory-set: green). The second alternative, a series of n sweeps according to the trigger definition, can be selected via the *SINGLE SWEEP* softkey in the same menu. Only one of the two softkeys can be active at a time, the softkeys thus act like selection switches.

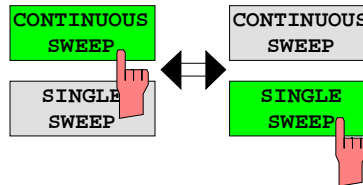

4. The softkey is used to select the parameter, the setting is made in an alphanumeric data entry window.

Example: SWEEP COUNT parameter

- Press *SWEEP* key
- Press *SWEEP COUNT* softkey.

The window for entering the number of sweeps for the *SINGLE SWEEP* mode is opened. The softkey is colored (factory-set: red). (Data entry is described in the next section).

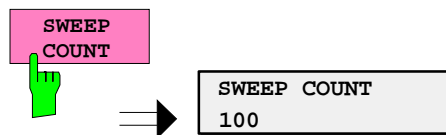

4. The softkey is used to select the parameter, the setting is made in an (alpha)numeric data entry window. The softkey function is switched on. To switch off the function, the softkey has to be pressed again.

Example: parameter MARKER

- Press *MRK* key.
- Press *MARKER 1* softkey.

The window for entering the marker frequency is opened. The softkey is colored (factory set: red). Marker1 is switched on and the peak search is started.



- Press *MARKER 2* softkey.

The entry window for the marker frequency of marker 2 is opened. The softkey is colored (red), marker 2 is switched on, and the *MARKER 1* softkey turns green.

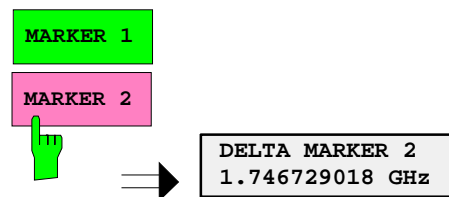

- Press *MARKER 1* softkey again.

Marker 1 is switched off.

5. The softkey selects the parameter, the setting is made in a selection table.

Example: Selection of the sorting criteria of a file list

- Press *FILE* key.
- Press *FILE MANAGER* softkey.
- Press *SORT MODE* softkey.

A selection table is displayed. The softkey is colored (factory-set: red). (operation see below).

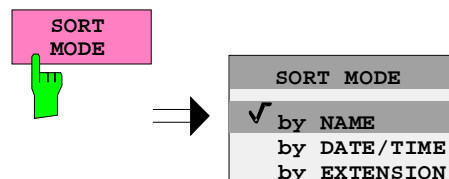



## Editing of Numeric Parameters

The entry of numeric values is always made in a data entry window, which is displayed automatically after selection of the parameter.

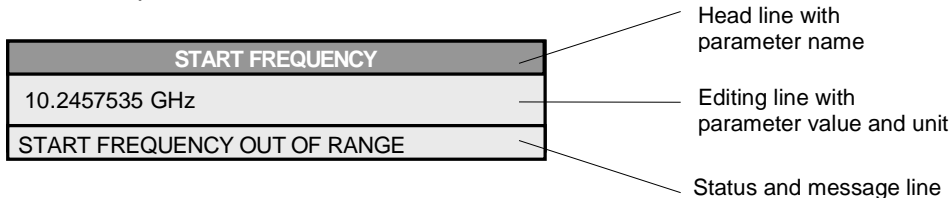

The headline indicates the name of the instrument parameter, which has been selected. The entry is made in the editing line. Subsequent to calling the entry window, the current parameter value including the unit is displayed left-justified in the editing line. Status and error messages which refer to the current entry are displayed in the third and (optionally) fourth line.

**Note:** Entry windows may be represented transparent (cf. DISPLAY - CONFIG DISPLAY menu)

### Entry of a numeric value

- Call data entry window (cf. selection of parameters)  
The editing line indicates the current value

Example: center frequency (frequency-sweep mode)

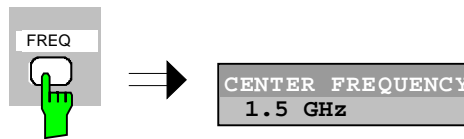

### Entry via number keys

- Enter required value via number keys.

Example:

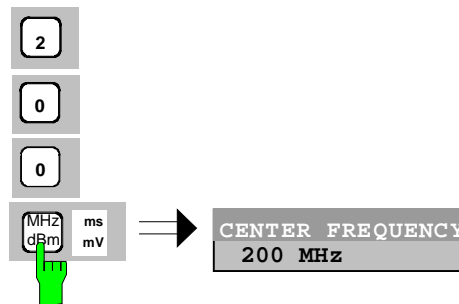

### Entry via cursor keys

- Cursor  or  until obtaining the required value.

Example:

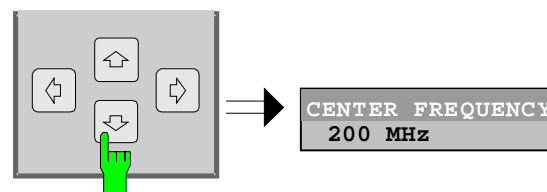

- Entry via roll-key
- Rotate the roll-key until reaching the required value.
 

The variation step size increases with increasing rotational speed.

Turning the roll-key clockwise increases the value, turning it counterclockwise decreases the value.

Example:

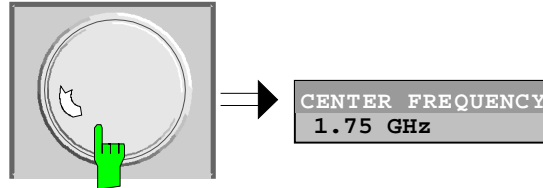

**Note:** When the value is modified by means of the roll-key or the cursor keys the new value is immediately set.

### Terminating the entry

- Press one of the unit keys
 

The unit is entered in the entry window and the new setting is accepted by the instrument.

For dimensionless quantities:

- Press the ENTER key or the roll-key
 

The new setting is accepted by the instrument.

A few data entry windows close automatically whereas others like the entry window for the start frequency remain open even after termination of the entry. They can be closed by pressing the *ESC* key.

If an error occurs, a corresponding error message is displayed in the status line of the entry window, e.g., "Out of range", "Value adjusted", etc. In this case, the new value is not accepted for the instrument setting.

Example:

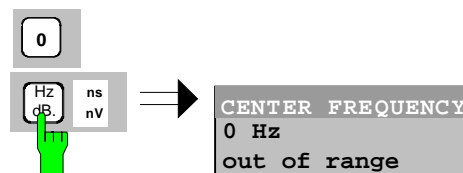

### Correcting the entry

- Deleting an entry
- Position the cursor beside the digit which is to be deleted using the cursor keys  $\leftarrow$  or  $\rightarrow$ .
  - Press the *BACK* key. The entry left to the cursor is deleted.
  - Enter new numbers. The number is inserted to the left of the cursor, the other numbers are shifted right.

Restoring the original value

- Press the *BACK* key

For numerous parameters, the data administration of the instrument stores the previously valid parameter value in addition to the current value. The *BACK* key can be used to toggle between these two values. This applies for terminated entries as long as the data entry window is displayed.

**Aborting the entry**

- Press *ESC* key

The original parameter value is restored. The new entry is deleted.

- Press *ESC* key again

The entry window is closed, the original value remains active.

or

- Press any key or any softkey (even the softkey which has opened the entry window).

The entry is aborted and the entry window is closed. The original value remains active.

## Entry of Alphanumeric Parameter

A help-line editor or an external keyboard (optional) are provided for the entry of alphanumeric instrument parameters.

The roll-key and the exponent key have no function with alphanumeric entry. All unit keys assume the function of an ENTER key.

The entry is always made in a data entry window which is displayed automatically upon selection of the parameter. The editing line comprises 60 characters. Up to 256 characters may be entered. If a text exceeds 60 characters the contents is shifted automatically 20 characters left or right when the left or right margin of the editing line is touched by the cursor.

## Editing with External Keyboard

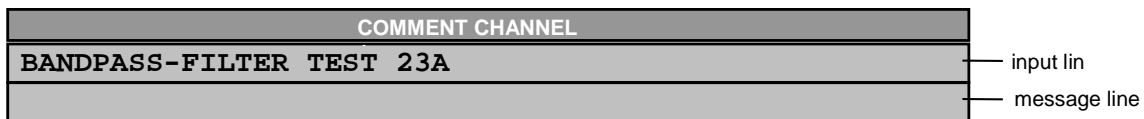

### Entry of text

- Select parameter.  
The data entry is active automatically upon calling the data entry window. The cursor is positioned at the beginning of the previous entry.
- Press the required character on the keyboard.  
The character is inserted prior to the cursor.
- Enter further characters

### Correcting the entry

- Delete the entry using the *DELETE* key or *BACKSPACE* key.

### Terminating the entry

- Press the *ENTER* key of the external keyboard  
The data entry window is closed and the new value is accepted for the instrument.



### Aborting the entry

- Press the **ESC** key on the front panel
- or
- any softkey.
- The data entry window is closed, the original value is retained.

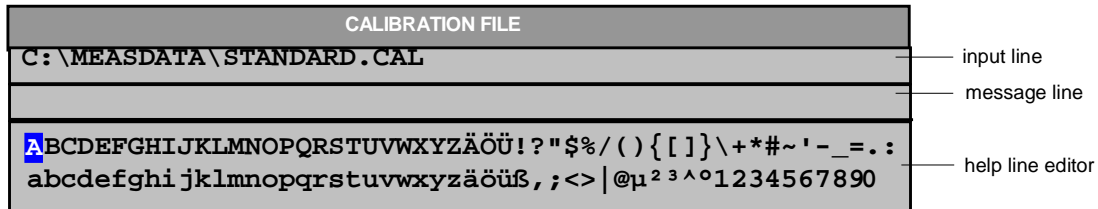

## Editing with Help Line Editor

If the external keyboard is not fitted, the help line editor is called automatically with entry of alphanumeric parameters. The help line editor is an extension of the alphanumeric entry window. It contains the complete alphabet with uppercase and lowercase letters as well as special characters in two lines of 52 characters, each. Individual letters and a series of special characters can be selected in the help line editor and copied into the entry line.





The cursor keys  or  toggle between entry in the editing line and selection in the help line editor.

### Entry of text

- Select parameter.  
The data entry is active automatically upon calling the data entry window. The cursor is positioned on the left in the editing line.
- Position the cursor in the help line editor using the cursor key.   
The cursor marks the first letter of the editor.
- Locate the cursor on the character which is to be entered into the editing line using the cursor keys  or  or the roll-key.
- Press the *ENTER* key or the roll-key  
The character is entered in the editing line.

### Correcting the entry

- Locate the cursor in the editing line using the cursor key .
- Position the cursor after the character which is to be deleted using the cursor keys  and .
- Press the *BACK* key.  
The entry left to the cursor is deleted.

### Terminating the entry

- Locate the cursor in the editing line using the cursor key .
- Press any unit key or the roll-key.  
The data entry window is closed, the new entry is accepted by the instrument.

### Aborting the entry

- Press the *CLR* key.  
The data entry window is closed, the previous entry is retained.

## Selection and Setting of Parameters via Tables

The receiver uses numerous tables for display and configuration of instrument parameters.

The tables differ considerably in the number of lines, columns and inscriptions. The basic steps of operation for the selection and setting of parameters are, however, the same for all tables. Shown below is the typical entry of parameters into a table.

**Note:**

*Most of the tables are coupled to a softkey menu which provides further functions for editing table entries such as deletion of tables, copying of lines or columns, marking of table elements, restoring default states.*

*The definition of individual tables and the operation of particular editing functions can be looked up in the description of the corresponding softkey menu.*

1. Activating the table

- If the menu has only one table, the latter is activated automatically subsequent to calling this menu in most cases and the marking cursor is positioned to the top field of the left column.
- If the menu contains various tables, the table of interest must be selected using the softkey which is labeled with the title of the table.

2. Selection of the parameter

LIMIT LINES				
NAME	COMPATIBLE	LIMIT CHECK	TRACE	MARGIN
GSM22UP	✓	off	1	0 dB
✓ LP1GHz		on	2	0 dB
✓ LP1GHz	✓	off	1	0 dB
MIL461A		off	2	-10 dB

marking cursor  
↓

Selection of the parameter (or the setting) is made using the marking cursor.

- Press the cursor keys to move to the wanted field.

or

- Rotate the roll-key until the wanted field is marked. The cursor keys are used to specify the direction of the roll-key movement (horizontal or vertical)

When shifting the cursor, elements may be skipped which can not be edited. Table elements, which can not be selected are indicated by a different color.

- Press the *ENTER* key or the roll-key.  
The parameter/the setting has been selected.

The selected parameter can be edited the way described below:

3. Editing the marked parameter

LIMIT LINES				
NAME	COMPATIBLE	LIMIT CHECK	TRACE	MARGIN
GSM22UP	✓	off	1	0 dB
✓ LP1GHz		on	2	0 dB
✓ LP1GHz	✓	off	1	0 dB
▲ MIL461A		off	2	-10 dB

checkmark

TRACE
1
✓ 2
3

MARGIN
-10 dB

a) Toggling between two states

If an element of a table can be switched on and off only, the unit keys are used to toggle between these two states.

- Press one of the unit keys.  
The table element is switched on and provided with a checkmark. (✓).
- Press one of the unit keys once more.  
The table element is switched off.

or

- Press one of the unit keys.  
The table element is switched on, "on" is displayed.
- Press one of the unit keys once more.  
The table element is switched off, "off" is displayed

## b) Opening a data entry window

If a table entry consists of an (alpha-) numeric value, selection of the latter causes the corresponding entry window to be opened.

**Note:** *For numeric or alphanumeric instrument parameters, the editing operation may be started by entering any number or letter on the front panel or on the external keyboard. In this case, the data entry window is opened automatically.*

## c) Opening a selection table

If a table entry may have various states (e.g., colors from a color pallet, fixed filter bandwidths, etc.), a table indicating all possible states is displayed with selection. The current state is and marked by a checkmark and by the cursor.

- Set the cursor to the desired setting.
- Press one of the unit keys.  
The setting is switched on and marked (√). The selection table closes and the value is transferred to the original table. The cursor is positioned automatically on the next table element.

**Abortion of entry**

- Press the *ESC* key.



The current entry/selection is aborted and the original setting is restored.

**Scrolling**

Some tables contain more entries than can be displayed on one screen page. In this case, a **scrollbar** is displayed at the right margin of the table, whose slider shows the current position in the text.

- Actuate the *PAGE UP* or *PAGE DOWN* softkeys.

The table is paged forward or back by one page.

- Press cursor key  or .

The table is scrolled up or down by one line.



# Menu Overview

The following section gives a graphical overview of the ESPI menus. Side menus are marked by an arrow directed to the left/right, submenus by an arrow showing upwards.

The menus appear in the order corresponding to the arrangement of keys on the front panel. The available hotkeys and the LOCAL menu appearing during the remote control of the instrument are also displayed.

The functions of menus are described in detail in Chapter 4. The IEC/IEEE-bus command associated with each softkey is indicated. In addition, the softkey list at the of Chapter 6 gives the assignment of IEC/IEEE-bus commands to softkeys.

## FREQ Key

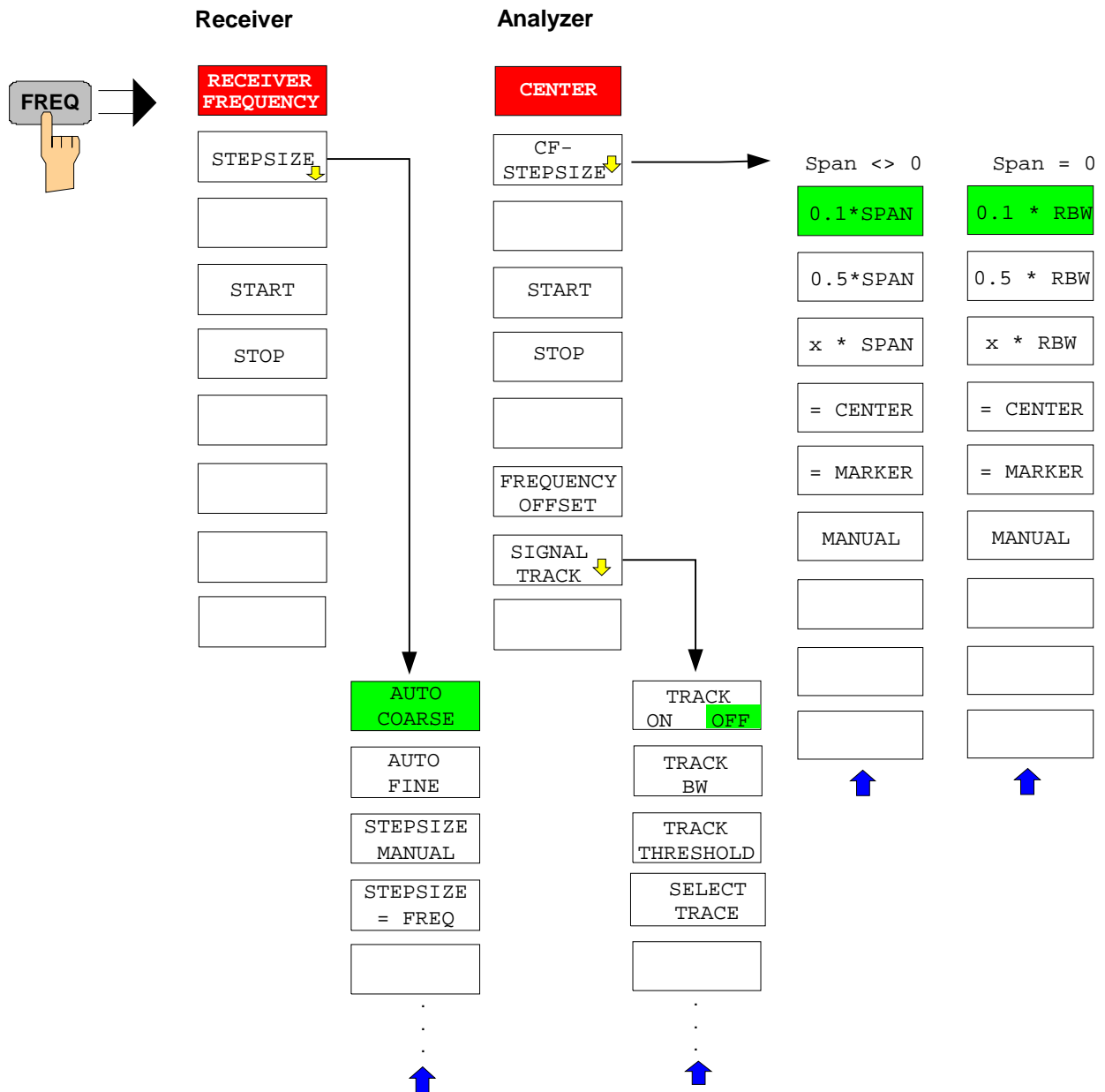

# SPAN Key

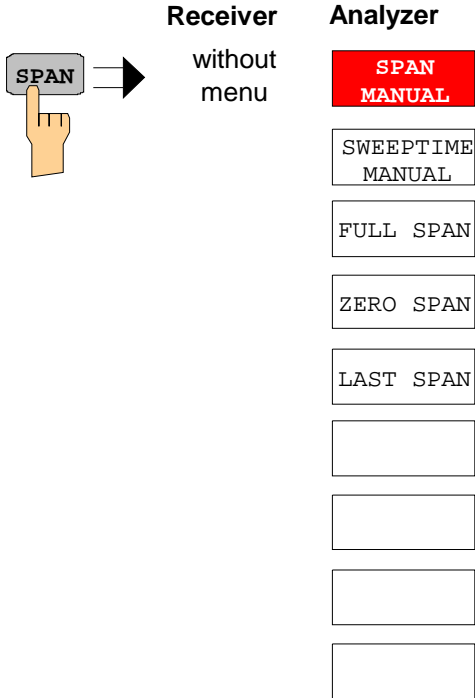

# AMPT Key

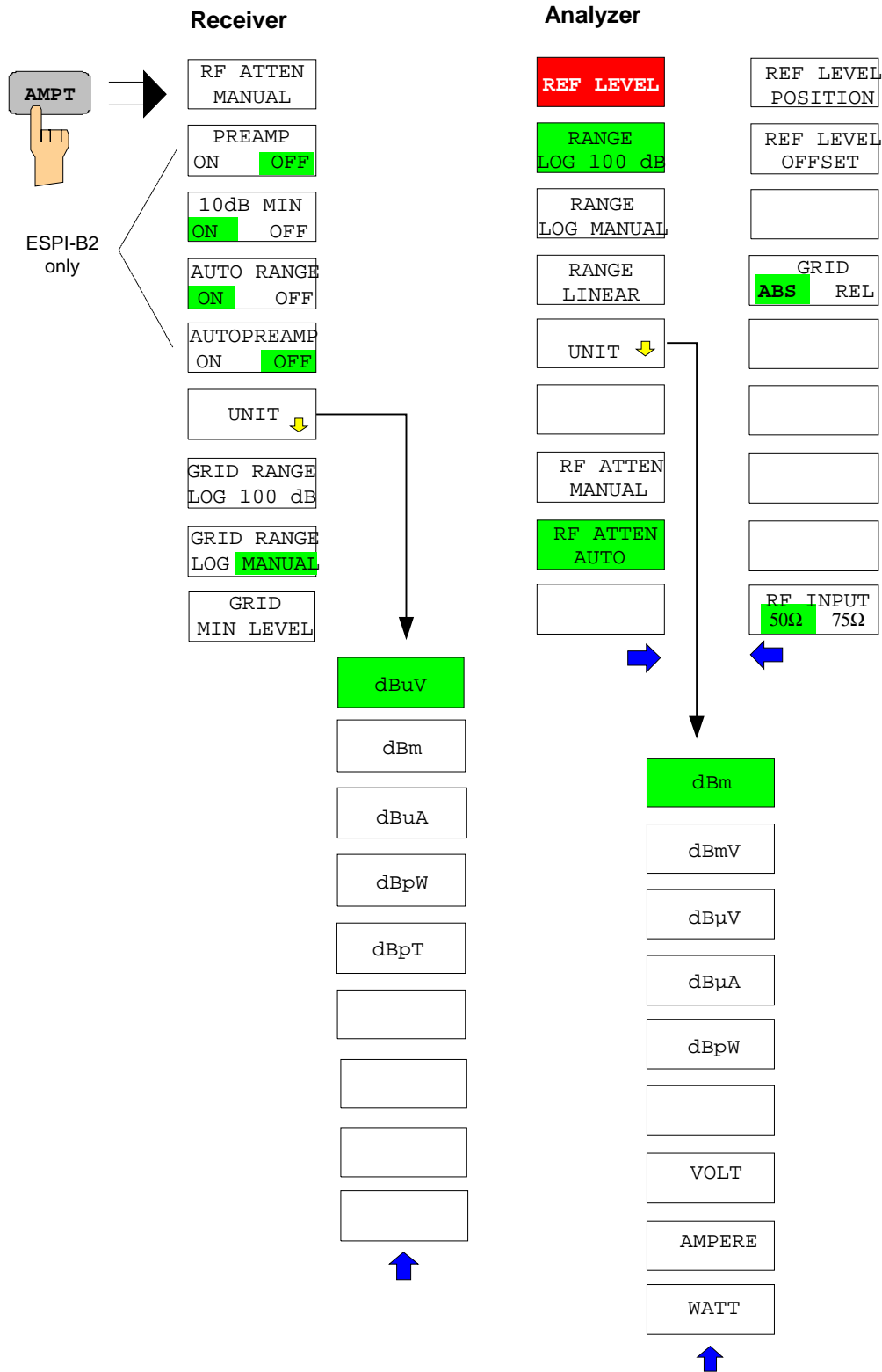

# MKR Key

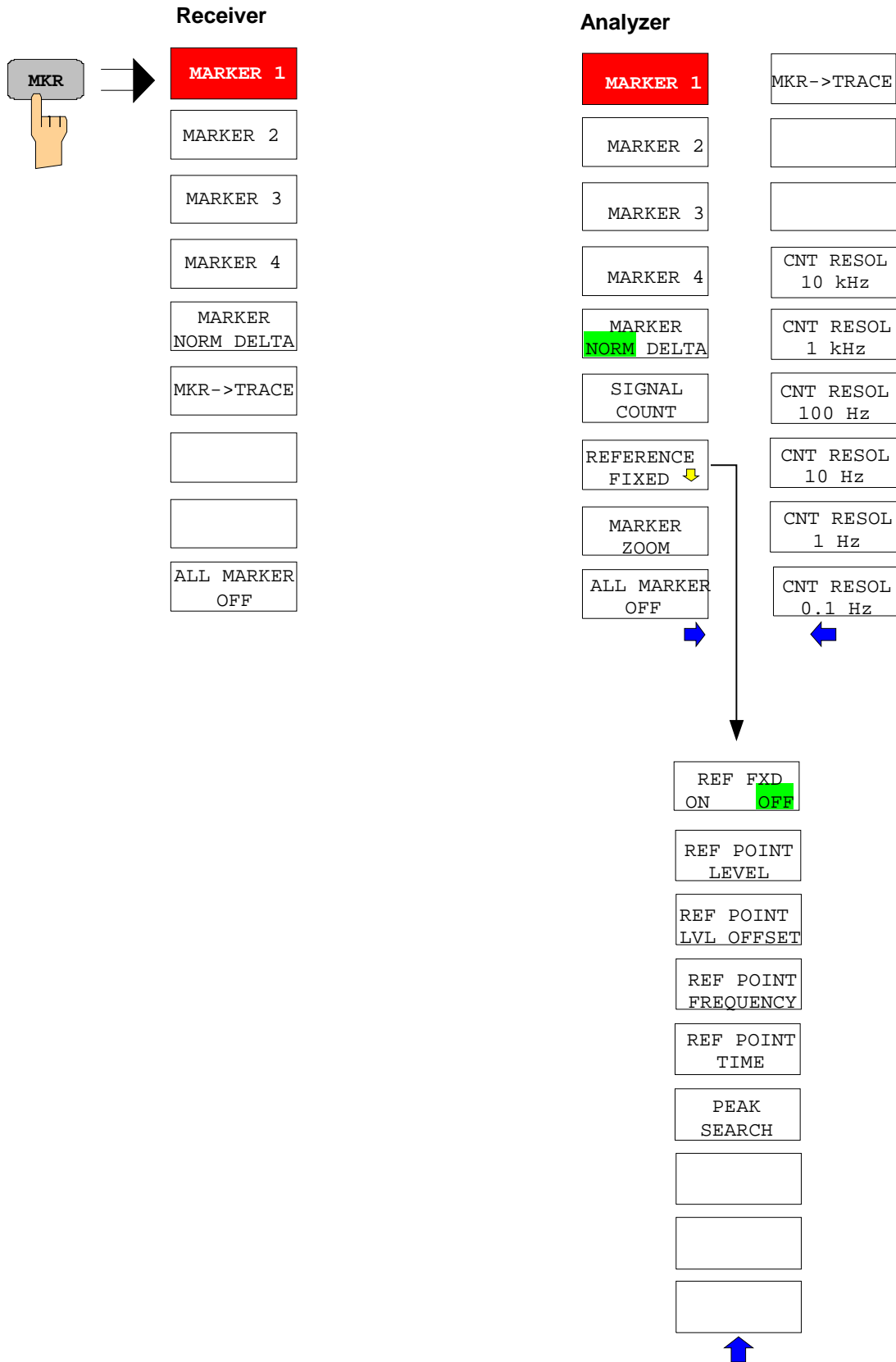

### MKR-> Key

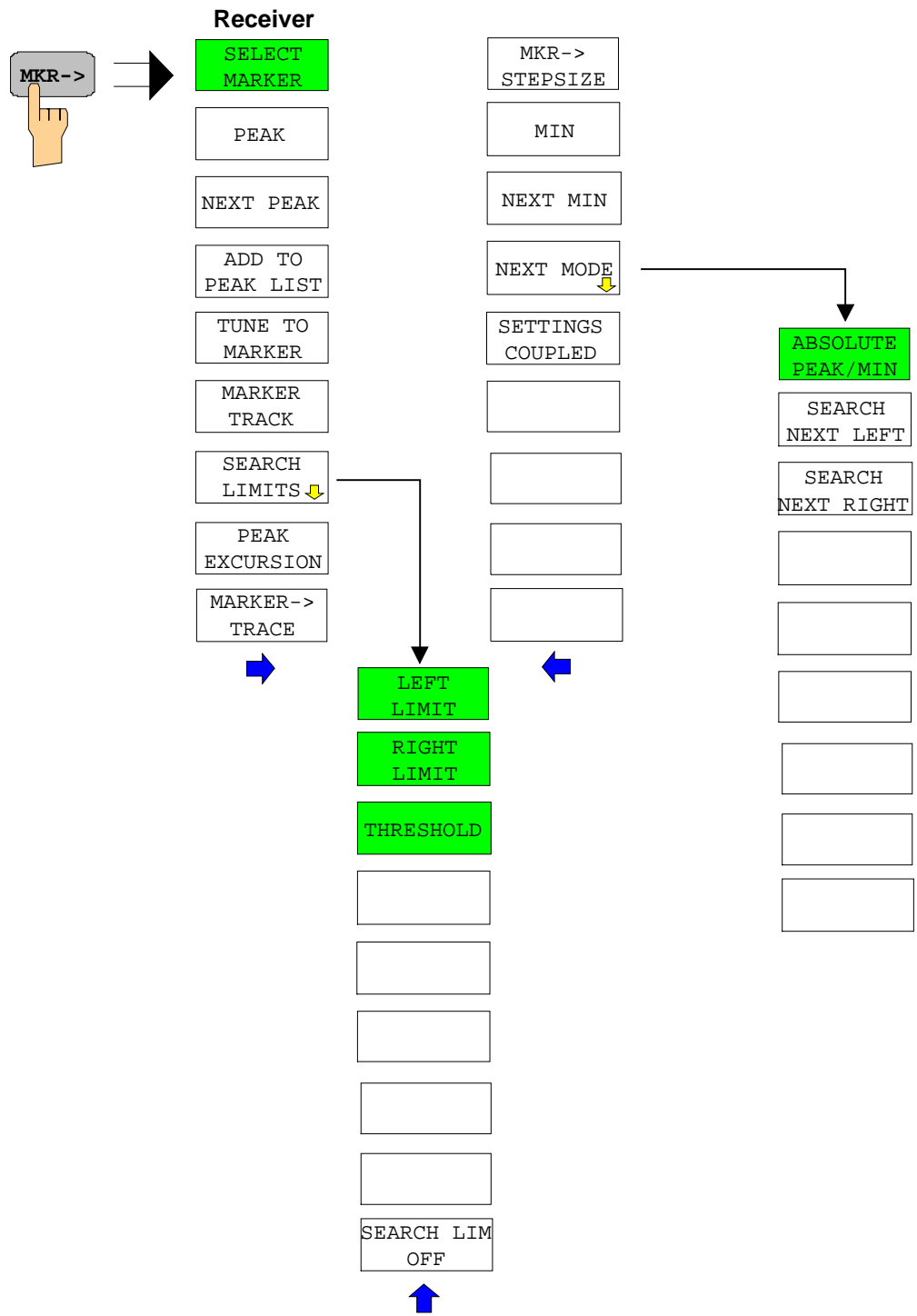

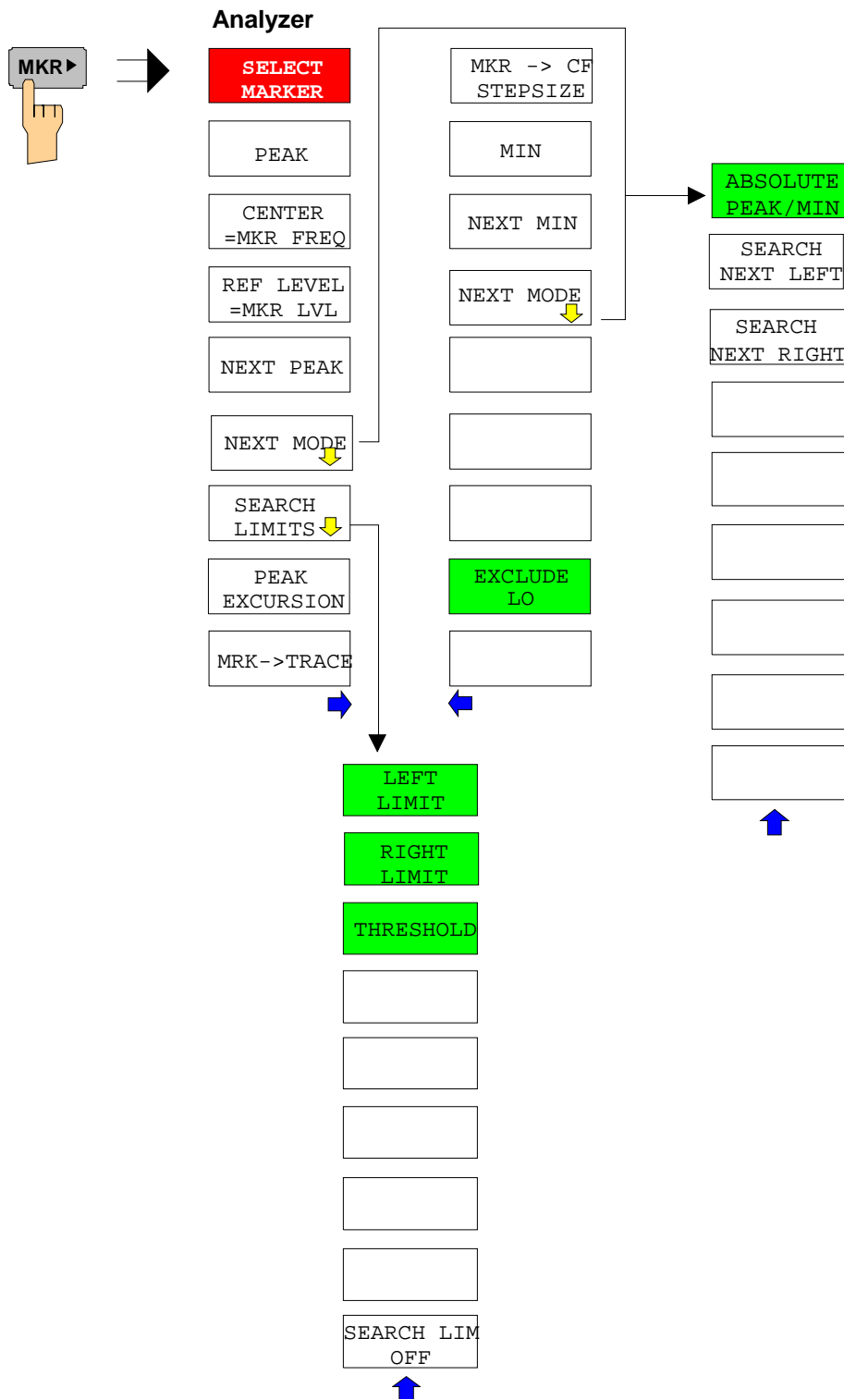

# MKR FCTN Key

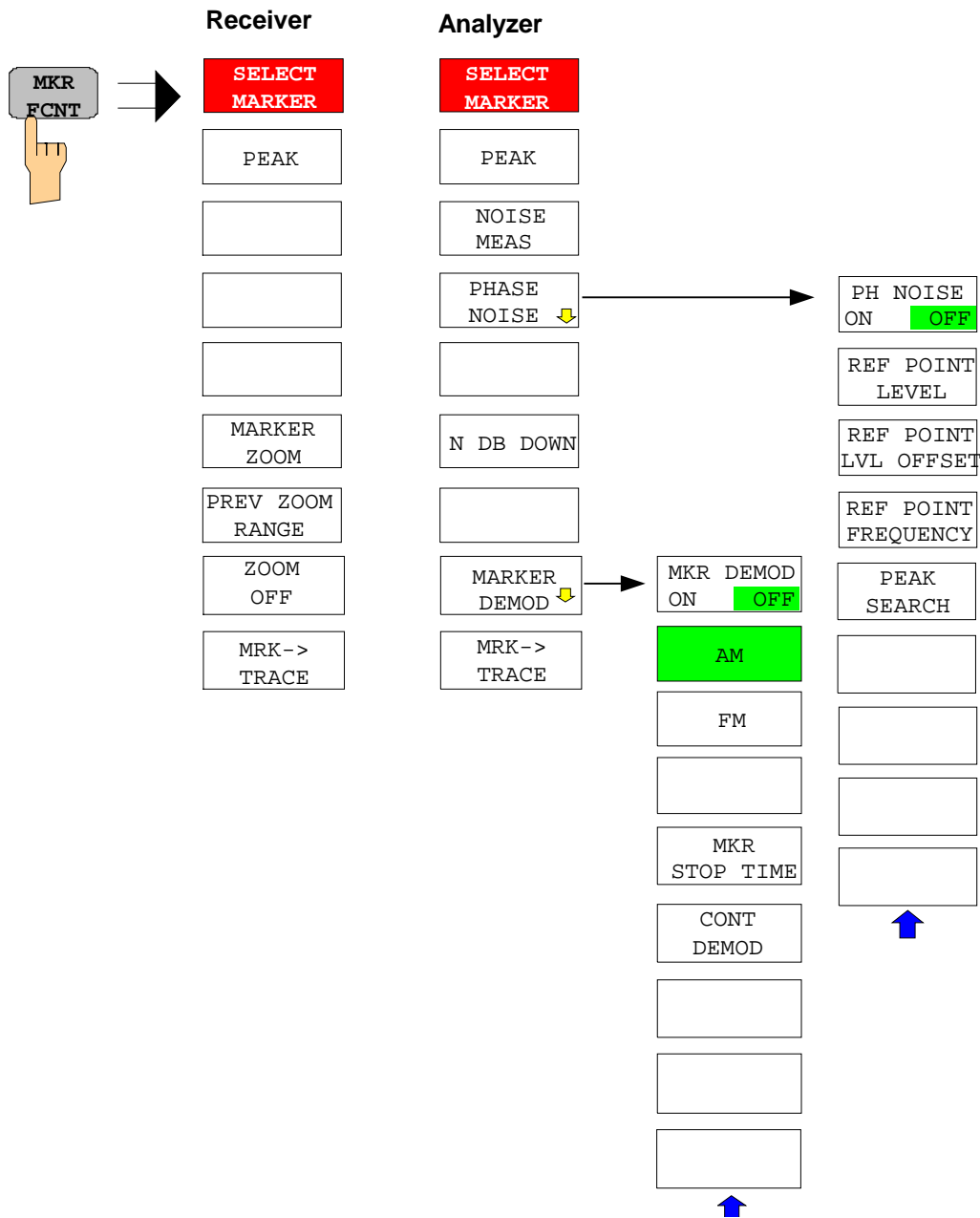

# BW Key

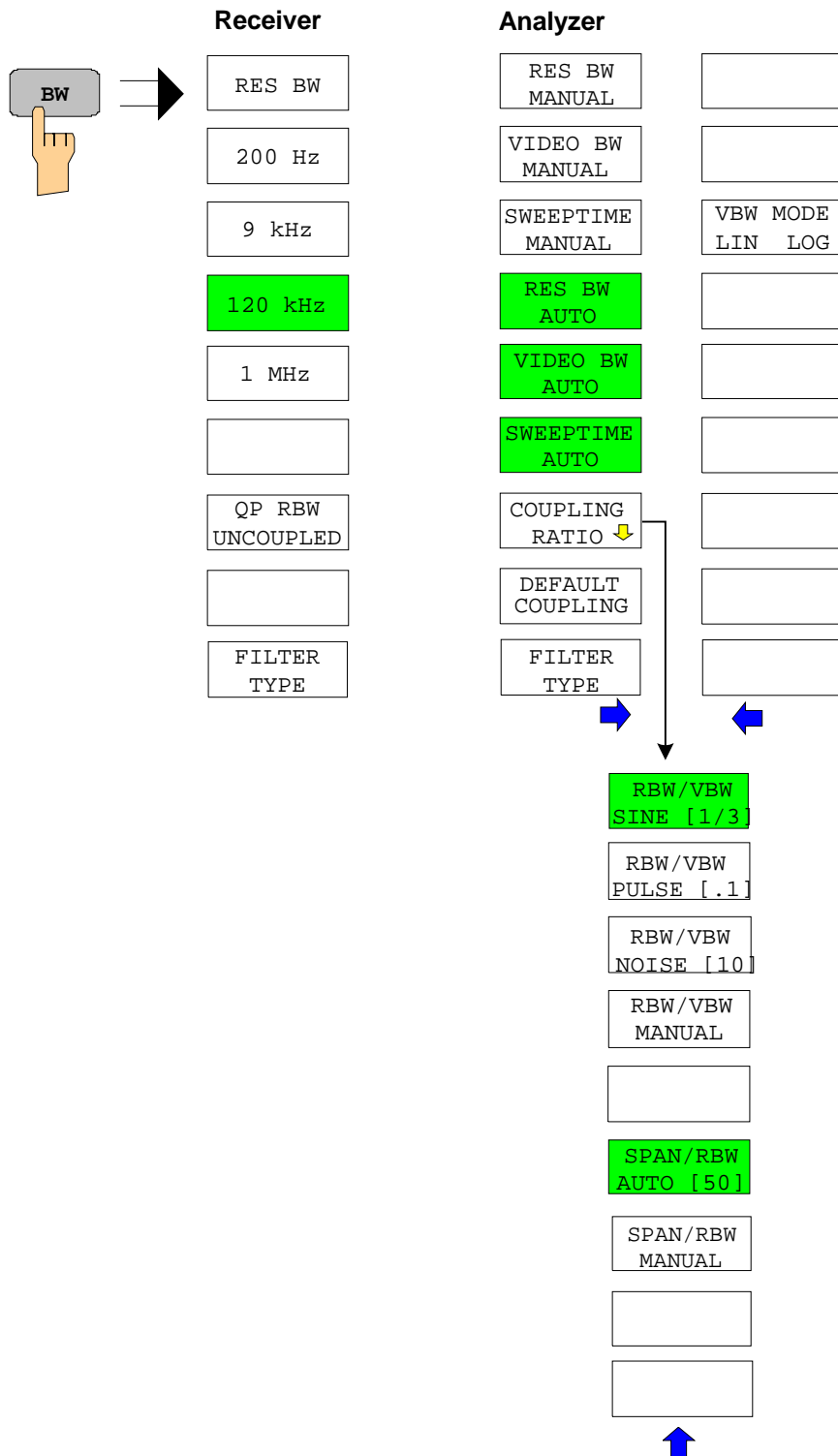



# SWEEP Key

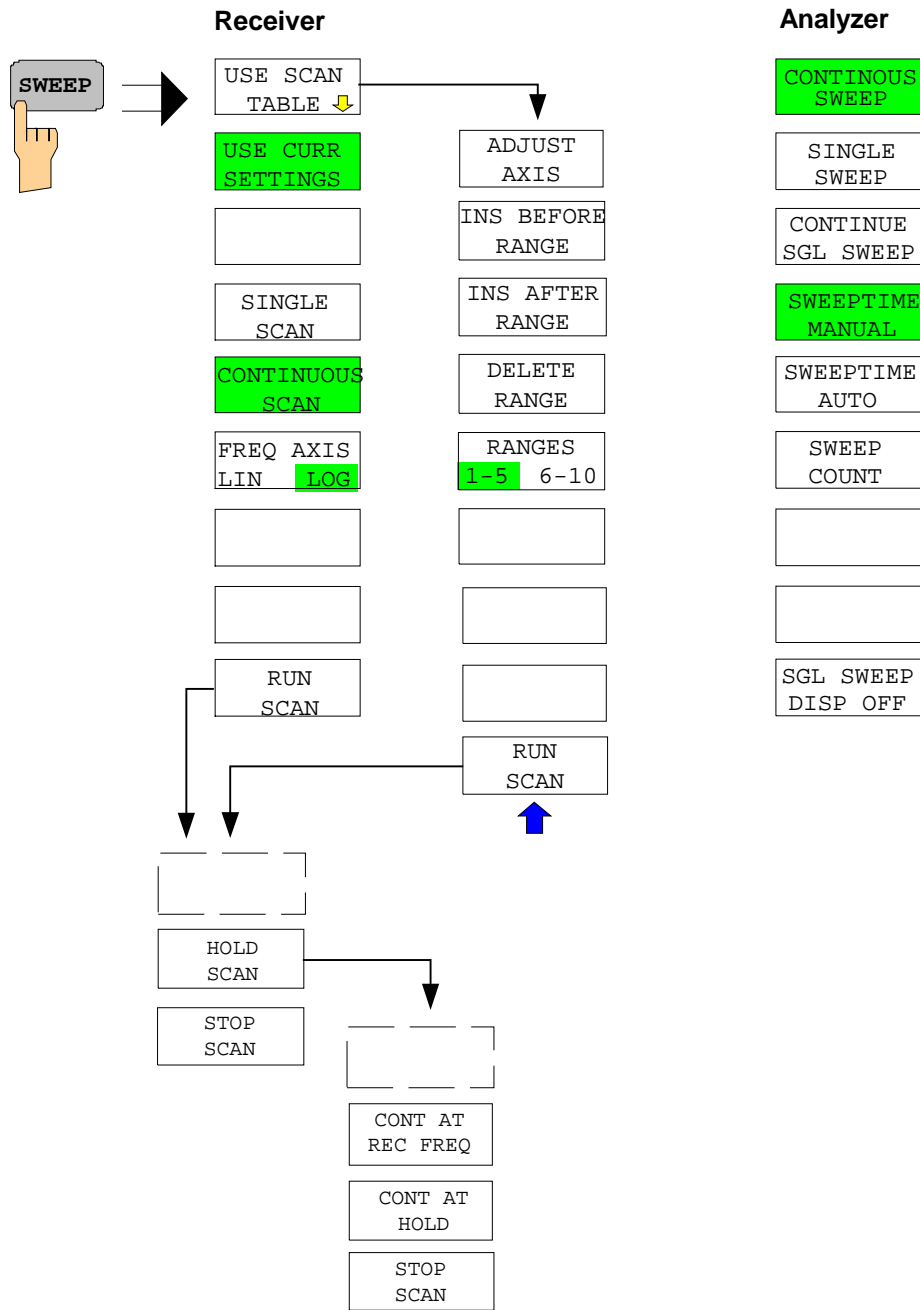

# MEAS Key

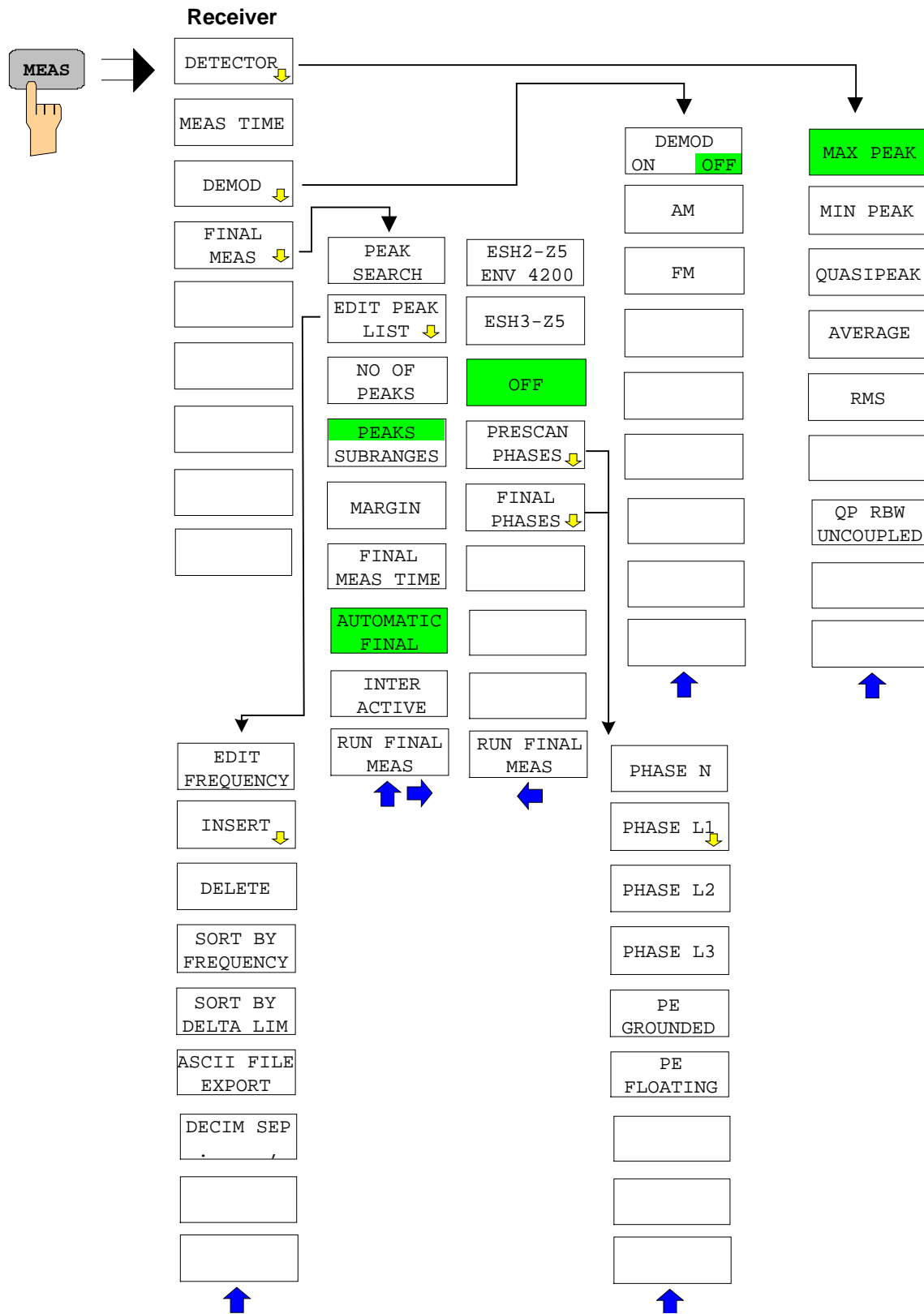

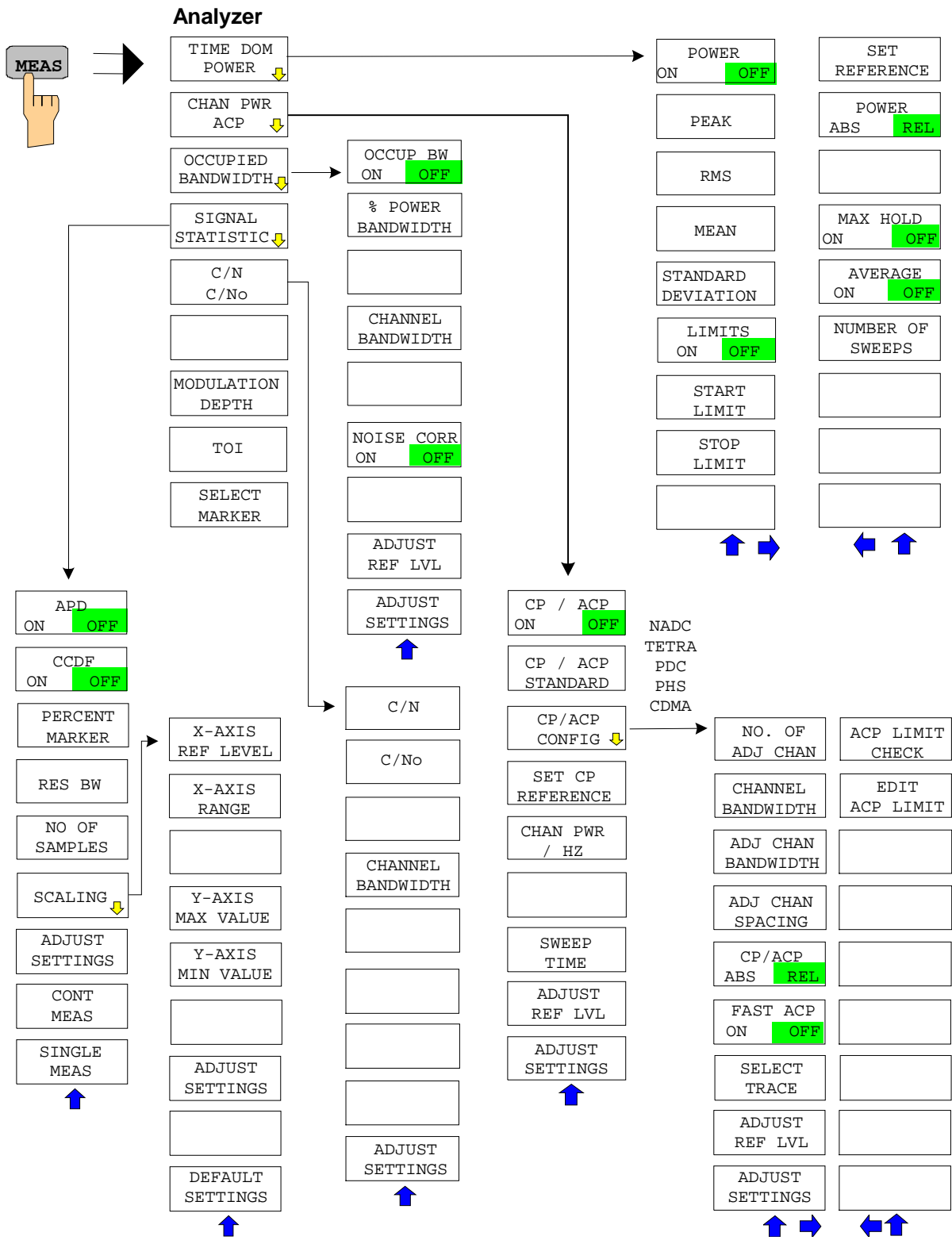

# TRIG Key

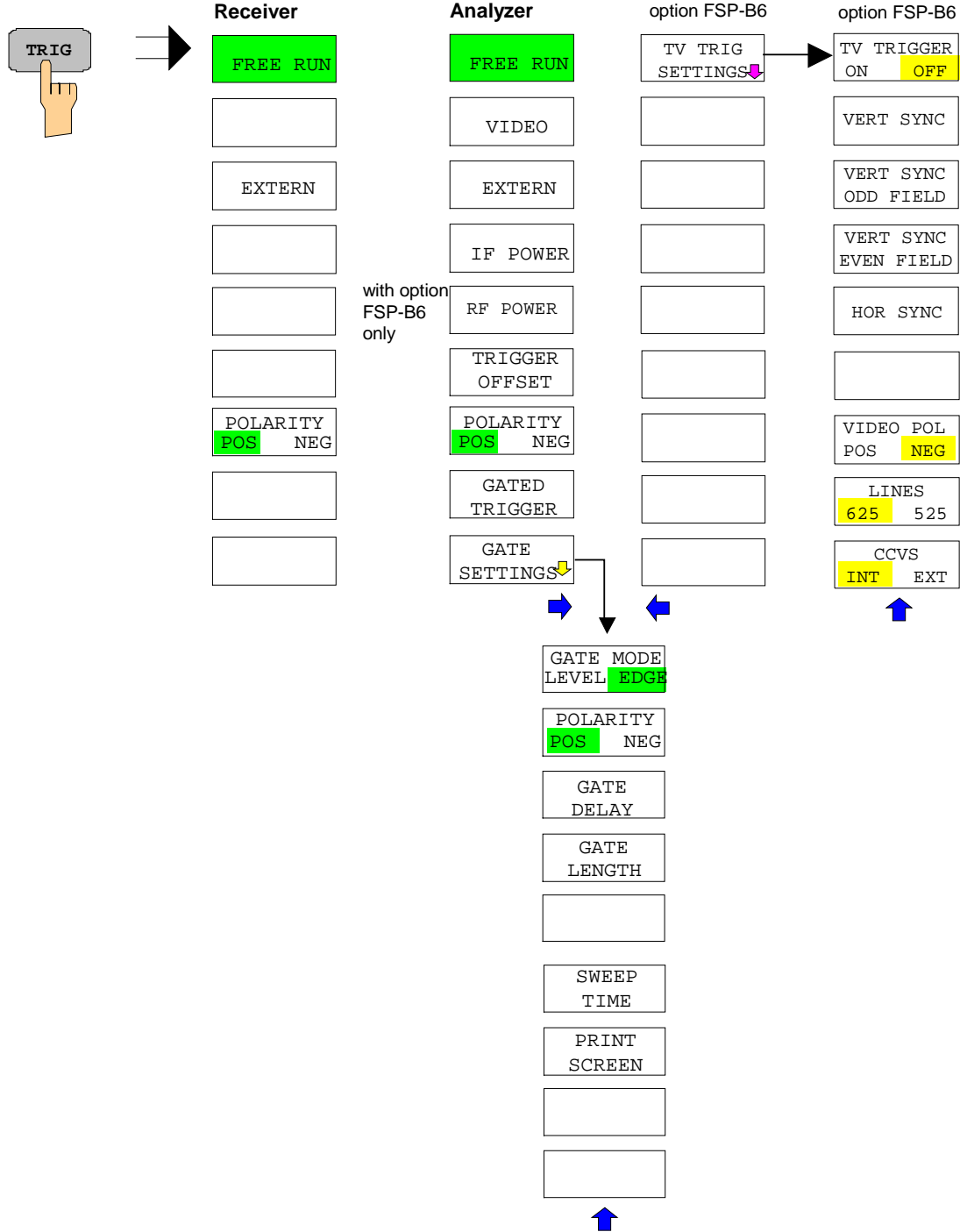

# TRACE Key

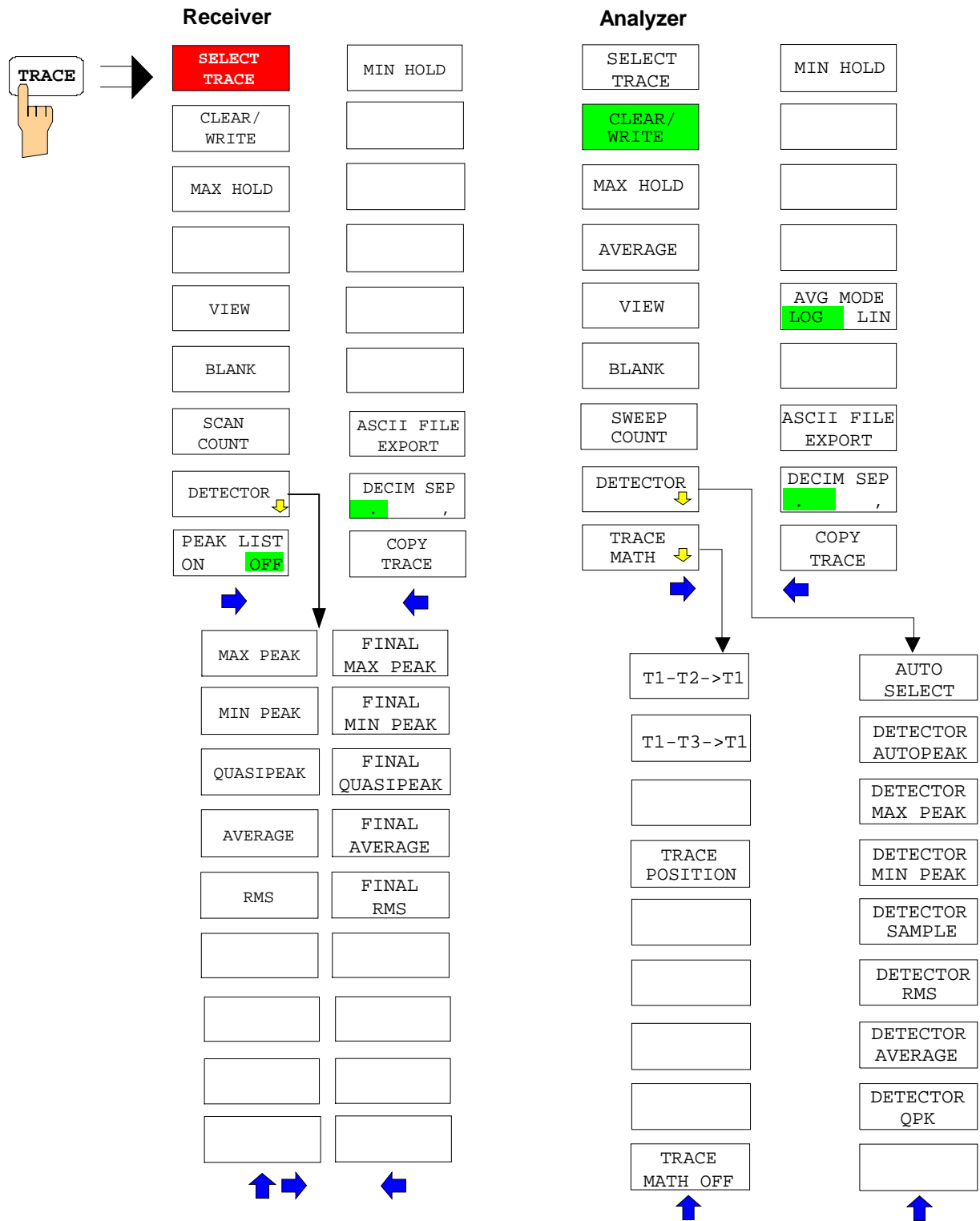

# LINES Key

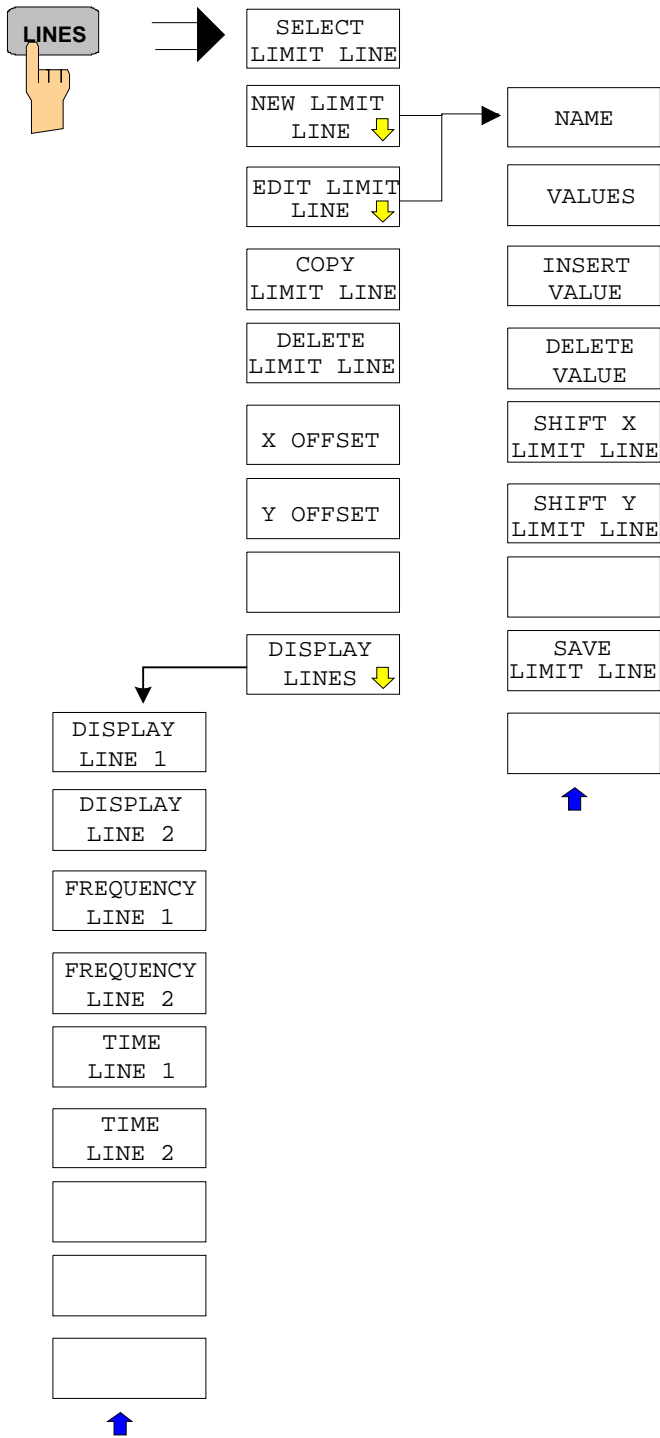

# DISP Key

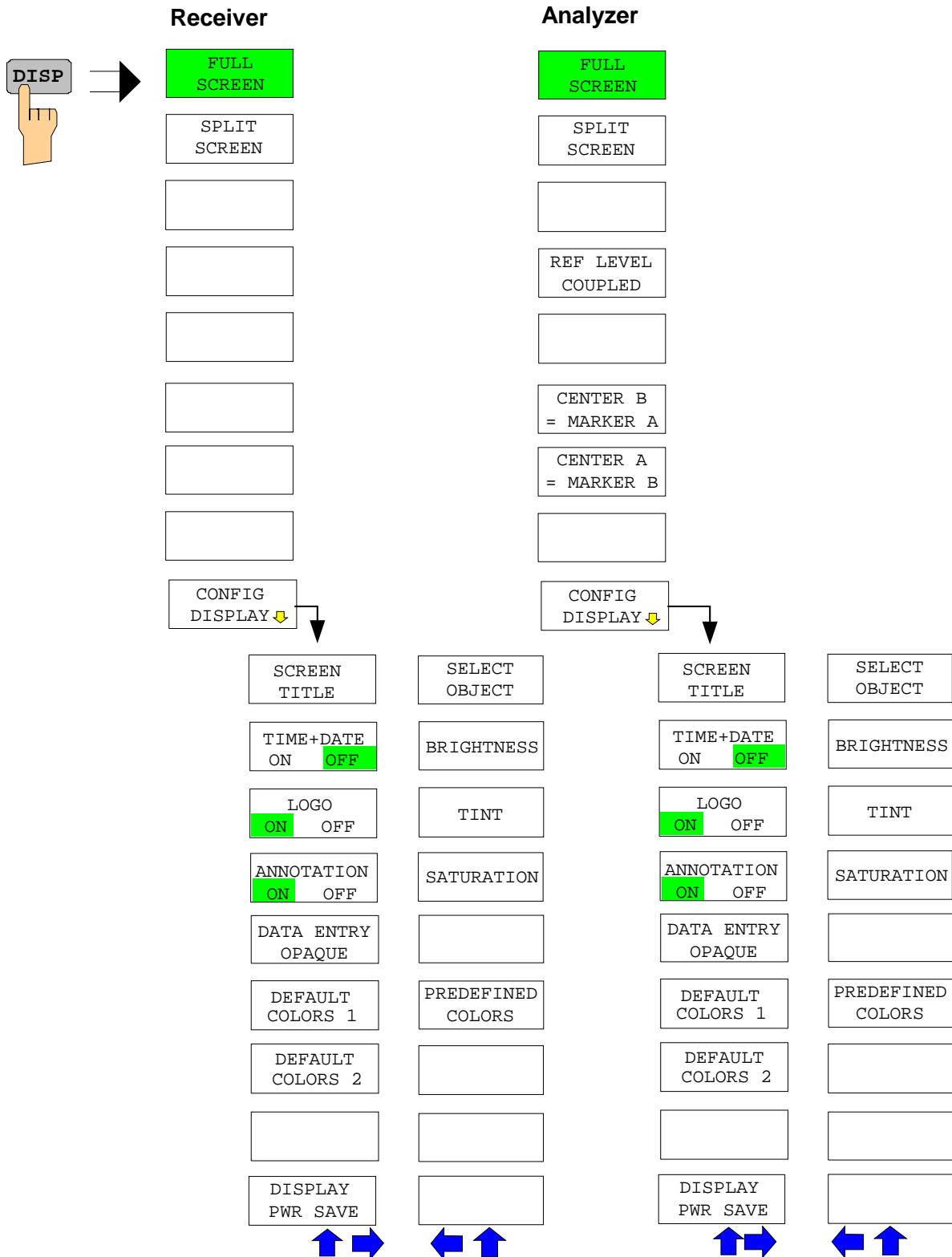

### FILE Key

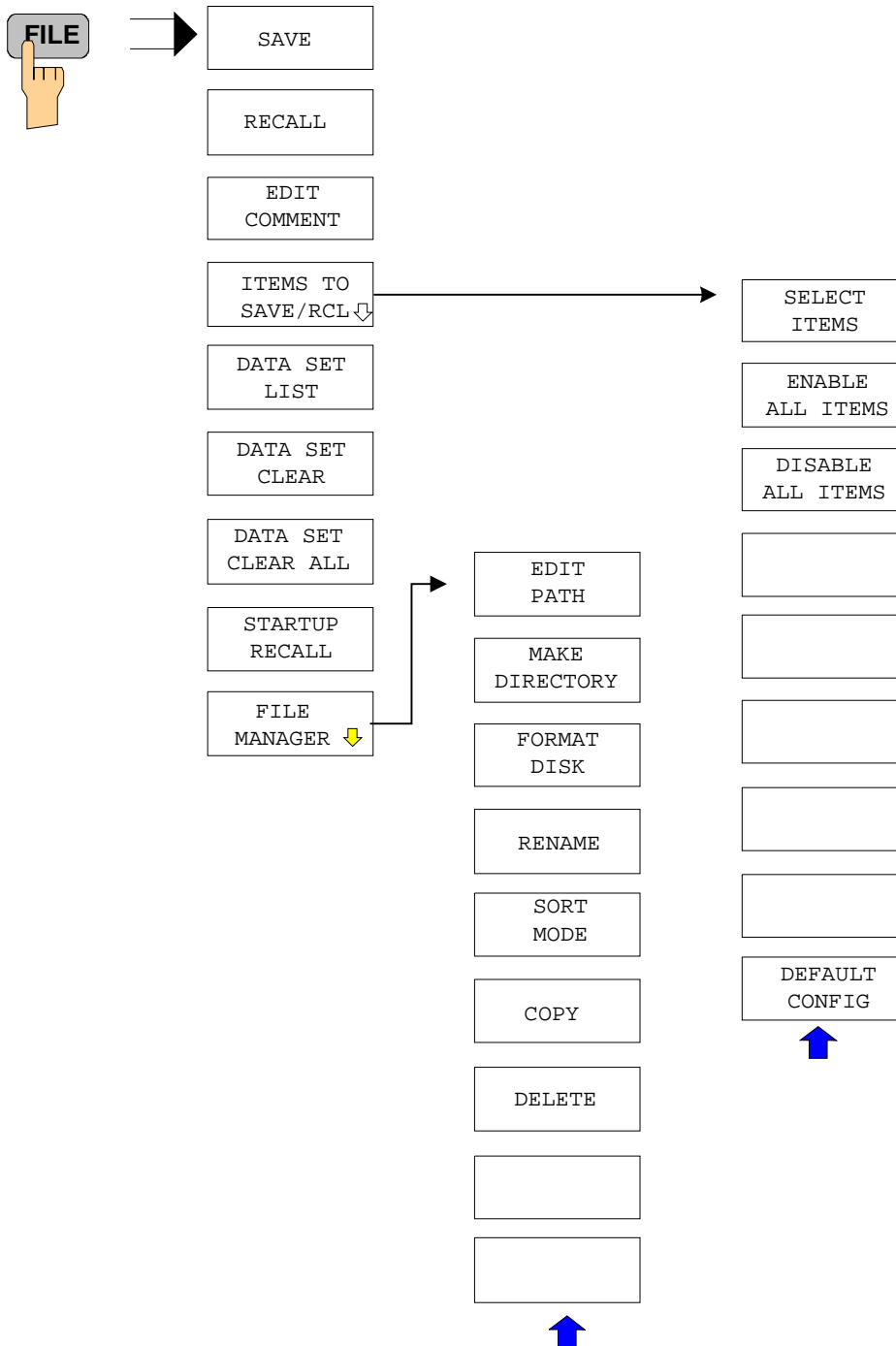



### CAL Key

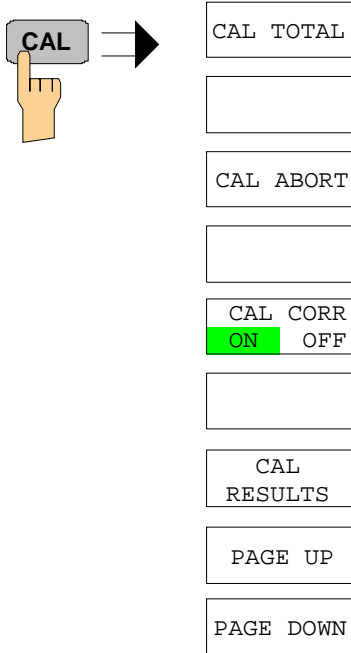

# SETUP Key

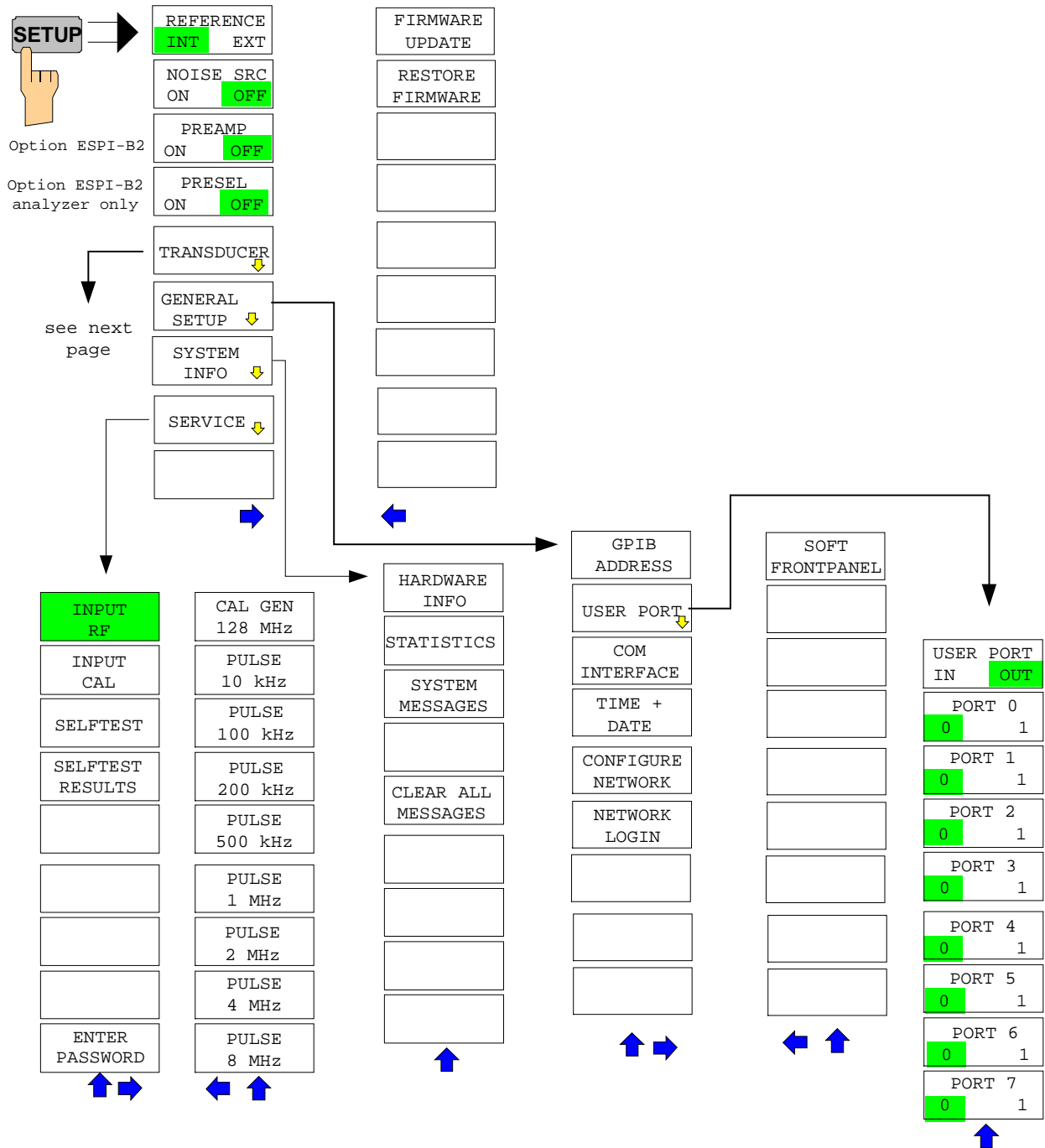

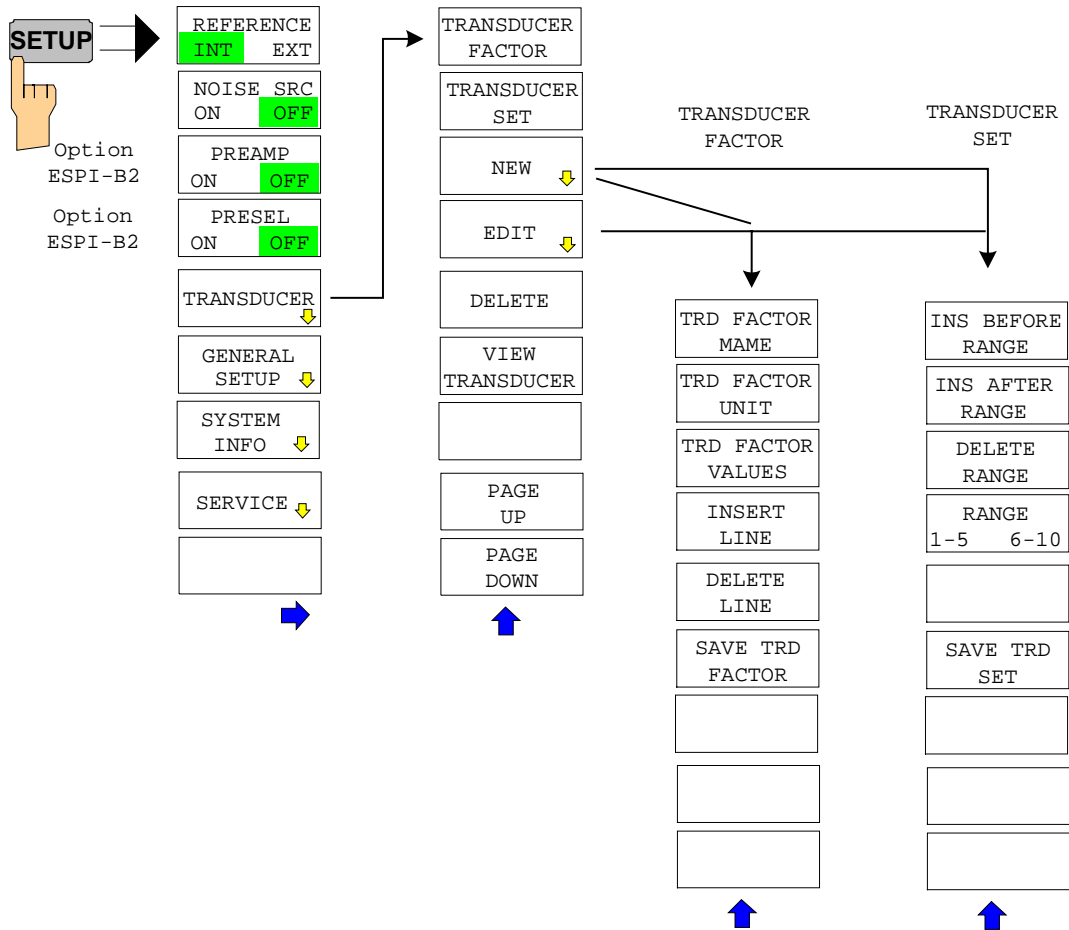

# HCOPY Key

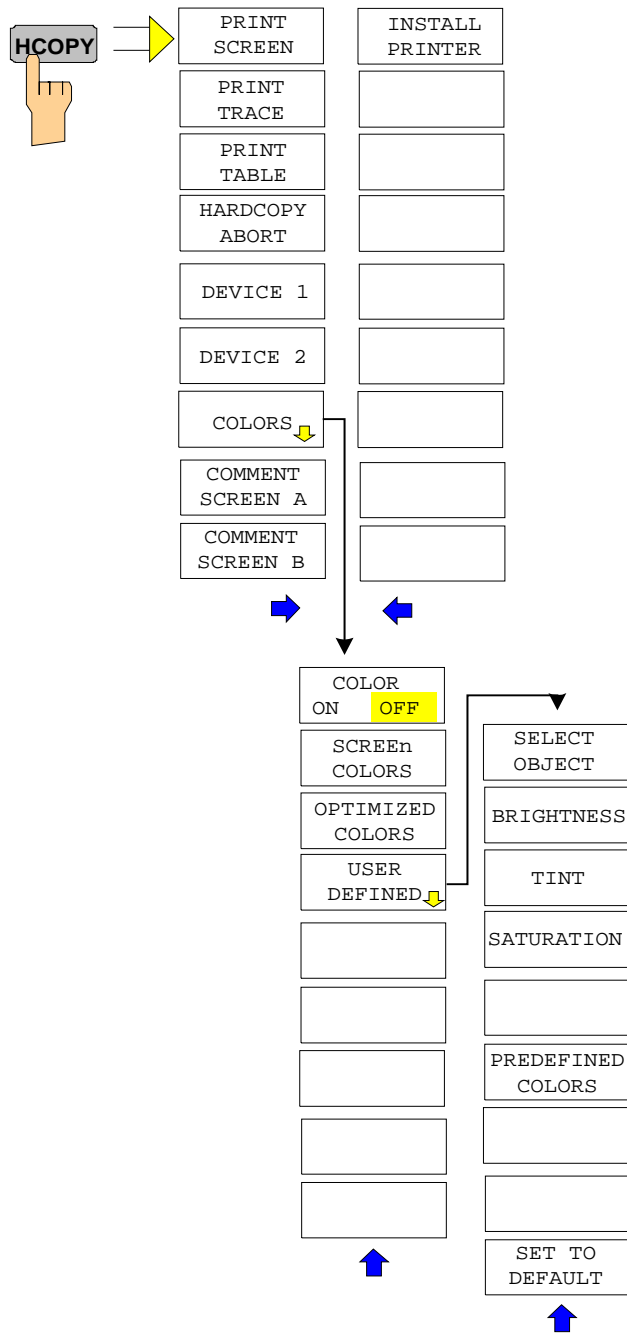

### Hotkey Menu

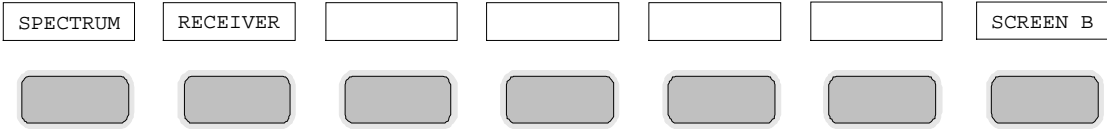

### LOCAL Menu

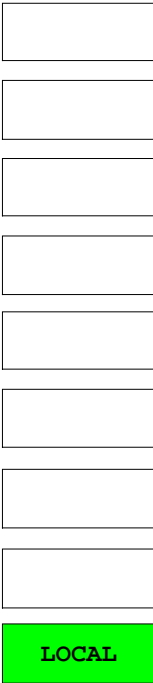

# Menu Overview RECEIVER Hotkey

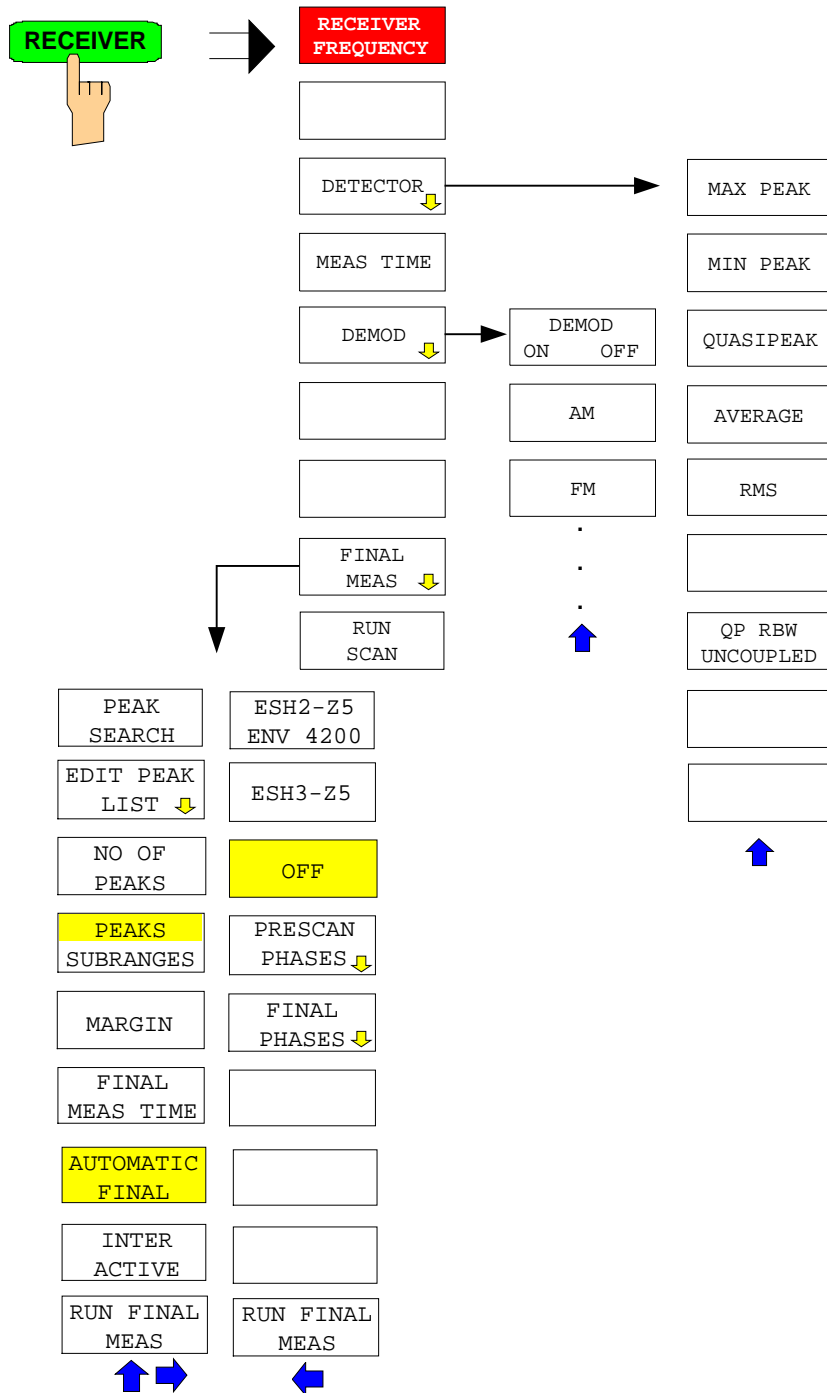

# Menu Overview Network Mode

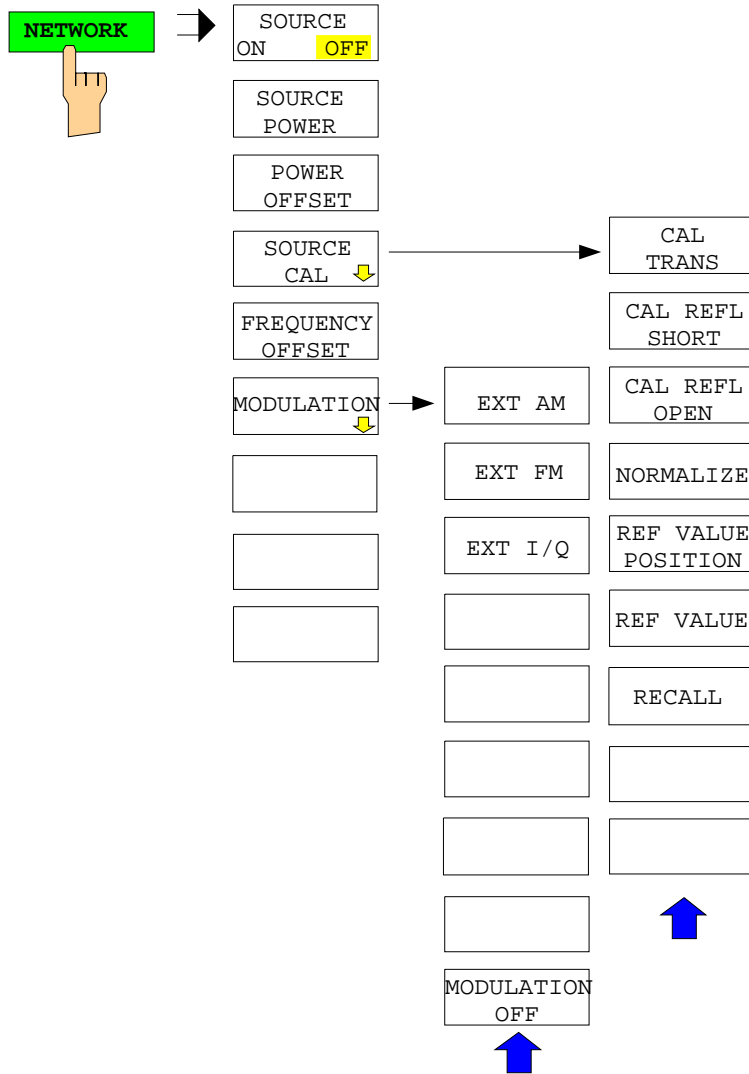

# Menu Overview Option Ext. Generator Control

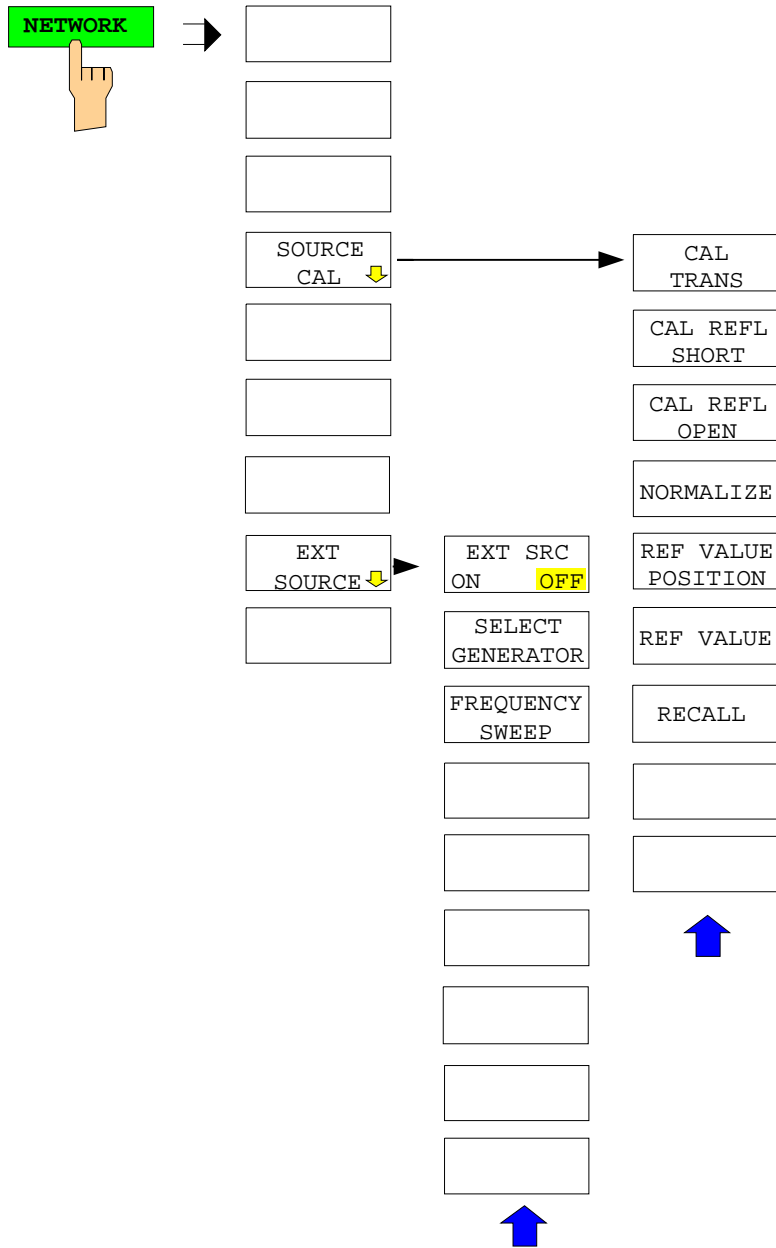





## Contents - Chapter 4 "Instrument Functions"

<b>4 Instrument Functions</b> .....	<b>4.1</b>
<b>ESPI Initial Configuration – PRESET Key</b> .....	<b>4.2</b>
<b>Mode Selection – HOTKEY Bar</b> .....	<b>4.3</b>
<b>Return to manual control – LOCAL Menu</b> .....	<b>4.4</b>
<b>RECEIVER Mode</b> .....	<b>4.5</b>
Operation on a Discrete Frequency.....	4.6
Setting the Receive Frequency and the Scan Range.....	4.6
Level Display and RF Input Configuration – AMPT Key .....	4.8
Preamplifier .....	4.9
Setting the IF Bandwidth - BW Key .....	4.11
List of Available Channel Filters .....	4.14
Selection of the Measurement Function – MEAS Key.....	4.15
Selecting the Detector .....	4.16
Setting the Measurement Time .....	4.18
AF Demodulators .....	4.20
Data Reduction and Peak List.....	4.21
Selection of Detectors for Final Measurement .....	4.32
Automatic Control of Line Impedance Stabilization Networks.....	4.33
Frequency Scan - SWEEP Key .....	4.37
Entry of Scan Data .....	4.39
Running a Scan.....	4.45
Triggering the Scan– TRIG Key.....	4.46
Marker Functions – MKR Key.....	4.47
Change of Settings via Markers – MKR ⇒ Key.....	4.48
Marker Functions – MKR FCTN Key.....	4.53
Selection and Setting of Traces –TRACE Key .....	4.54
Selection of Trace Function.....	4.54
<b>Spectrum Analyzer Mode</b> .....	<b>4.61</b>
Frequency and Span Selection – FREQ Key.....	4.61
Setting the Frequency Span – SPAN Key .....	4.66
Level Display Setting and RF Input Configuration – AMPT Key.....	4.67
Setting the Bandwidths and Sweep Time – BW Key .....	4.71
List of available channel filters .....	4.78
Sweep Settings – SWEEP Key.....	4.80
Triggering the Sweep– TRIG Key.....	4.83
Option FSP-B6 - TV- and RF-Trigger.....	4.90
Selection and Setting of Traces – TRACE Key .....	4.92
Selection of Trace Function.....	4.92
Selection of Detector .....	4.100
Mathematical Functions for Traces .....	4.105
Recording the Correction Data of ESPI – CAL Key.....	4.106
Markers and Delta Markers – MKR Key .....	4.108
Frequency Measurement with the Frequency Counter .....	4.110
Marker Functions – MKR FCTN Key .....	4.115
Activating the Markers.....	4.116
Measurement of noise density .....	4.116

Phase Noise Measurement .....	4.118
Measurement of the Filter or Signal Bandwidth .....	4.120
AF Demodulation.....	4.121
Selecting the Trace .....	4.122
Change of Settings via Markers – <i>MKR</i> ⇒ Key.....	4.123
Power Measurements – Hardkey <i>MEAS</i> .....	4.131
Power Measurement in Time Domain.....	4.132
Channel and Adjacent-Channel Power Measurements .....	4.137
Setting the Channel Configuration.....	4.144
Measurement of Signal Amplitude Statistics .....	4.155
Signal / Noise Power Measurement .....	4.161
Measurement of the AM Modulation Depth.....	4.163
Measurement of the Third Order Intercept (TOI) .....	4.164
<b>Setup of Limit and Display Lines– <i>LINES</i> Key .....</b>	<b>4.167</b>
Selection of Limit Lines.....	4.168
Entry and Editing of Limit Lines .....	4.172
Display Lines .....	4.177
<b>Configuration of Screen Display – <i>DISP</i> Key .....</b>	<b>4.179</b>
<b>Instrument Setup and Interface Configuration – <i>SETUP</i> Key.....</b>	<b>4.186</b>
External Reference Oscillator.....	4.187
External Noise Source .....	4.187
Preamplification and Preselection .....	4.188
Preselection.....	4.188
Preamplification.....	4.189
Using Transducers .....	4.190
Activating Transducer Factors and Transducer Sets .....	4.191
New Entry and Editing of Transducer Factors.....	4.194
New Entry and Editing of Transducer Sets .....	4.198
Programming the Interface Configuration and Time Setup .....	4.202
Selecting the IEC/IEEE-bus address.....	4.202
User Port Configuration .....	4.203
Serial Interface Configuration.....	4.204
Setting Date and Time.....	4.207
Configuration of network settings (with option FSP-B16 only) .....	4.208
Emulation of the instrument front panel .....	4.210
System Information.....	4.211
Display of Module Data .....	4.211
Display of Device Statistics .....	4.212
Display of System Messages .....	4.213
Service Menu.....	4.214
General Service Functions .....	4.215
Selftest .....	4.216
Hardware Adjustment.....	4.217
Firmware Update .....	4.217
<b>Saving and Recalling Data Sets – <i>FILE</i> Key .....</b>	<b>4.218</b>
Saving a Data Set.....	4.219
Recalling a Data Set: .....	4.219
FILE Menu .....	4.220
<b>Measurement Documentation – <i>HCOPY</i> Key .....</b>	<b>4.227</b>
Selection of Print Colors .....	4.232

<b>Tracking Generator - Option FSP-B9 .....</b>	<b>4.235</b>
Tracking Generator Settings.....	4.236
Transmission Measurement.....	4.238
Calibration of Transmission Measurement.....	4.238
Normalization.....	4.240
Reflection Measurement.....	4.244
Calibration of Reflection Measurement .....	4.244
Calibration mechanism .....	4.245
Frequency-Converting Measurements .....	4.246
External Modulation of the Tracking Generator.....	4.247
<b>Option External Generator Control - FSP-B10 .....</b>	<b>4.250</b>
External Generator Settings .....	4.251
Transmission Measurement.....	4.252
Calibration of Transmission Measurement.....	4.252
Normalization:.....	4.254
Reflection Measurement.....	4.258
Calibration of Reflection Measurement .....	4.258
Calibration mechanism .....	4.259
Frequency-converting Measurements .....	4.260
Configuration of an External Generator.....	4.261
List of Generator Types Supported by the ESPI.....	4.263
<b>Option LAN Interface – FSP-B16 .....</b>	<b>4.266</b>
Connecting the Instrument to the Network .....	4.266
Installing the Software .....	4.266
Installation and Configuration of the Driver for the Network Card.....	4.266
Selection of the Network Protocols .....	4.269
Selection of the Network Services.....	4.269
Completion of the Installation .....	4.270
Examples of Configurations .....	4.272
Subsequent Changing of the Network Configuration (Computer Name etc.) .....	4.273
Deinstallation of the Network Driver – Installation of the MS Loopback Adapter .....	4.273
Operating the Instrument on the Network.....	4.277
NOVELL Networks .....	4.277
MICROSOFT Network.....	4.277
Defining Users.....	4.278
Login in the Network.....	4.279
Disabling the Autologin-mechanism .....	4.279
Re-enabling the Autologin-mechanism .....	4.279
Using Network Drives.....	4.280
Printing on a Network Printer .....	4.282
Remote Data Transfer with TCP/IP Services.....	4.284
<b>RSIB Interface .....</b>	<b>4.286</b>
Remote Control via RSIB Interface .....	4.286
Windows Environment .....	4.286
Unix Environment .....	4.287
RSIB Interface Functions.....	4.288
Programming via the RSIB Interface.....	4.296
Visual Basic.....	4.296
Visual Basic for Applications (Winword and Excel).....	4.299
C / C++ .....	4.300



## 4 Instrument Functions

All functions of the EMI test receiver and their application are explained in detail in this chapter. The sequence of the described menu groups depends on the procedure selected for the configuration and start of a measurement:

1. Resetting the instrument - *PRESET* key
2. Setting the mode – hotkey bar and *LOCAL* key
3. Setting the measurement parameters - keys *FREQ*, *SPAN*, *AMPT*, *BW*, *SWEEP*, *TRIG*, *TRACE*, *CAL*

Selecting and configuring the measurement function - keys *MKR*, *MKR->*, *MKR FCTN*, *MEAS*

The instrument functions for general settings, printout and data management are described at the end of this chapter – keys *LINES*, *DISP*, *SETUP*, *FILE* and *HCOPY*.

The different softkeys of a menu are described from top to bottom and from the left to the right side menu. The submenus are marked by an indentation or displayed in a separate section. The whole path (key - softkey - ...) is indicated in the line above the menu display.

An overview of the menus is given in chapter 3 which also contains the description of the operating concept.

The IEC/IEEE-bus commands (if any) are indicated for each softkey. For a fast overview a list of softkeys with the associated IEC/IEEE-bus commands is given at the end of Chapter 6.

An index at the end of the handbook serves as further help for the user.

## ESPI Initial Configuration – PRESET Key



Using the *PRESET* key, the ESPI can be set to a predefined initial state.

**Notes:** *The settings are selected in a way that the RF input is always protected against overload, provided that the applied signal levels are in the allowed range for the instrument.*

*The initial instrument state set by the PRESET key can be adapted to arbitrary applications using the STARTUP RECALL function. With this function the STARTUP RECALL dataset is loaded upon pressing the PRESET key. For further information refer to section "Saving and Recalling Data Sets".*

Pressing the *PRESET* key causes the ESPI to enter its initial state according to the following table:

Table 4-1 Initial State of ESPI

Parameter	Settings
Mode	Spectrum
Center frequency)	1,5 GHz / 3,5 GHz (ESPI-3/-7)
Center frequency step size	0.1 * center frequency
Span	3 GHz / 7 GHz (ESPI-3/-7)
RF attenuation	auto (10 dB)
Reference level	-20 dBm
Level range	100 dB log
Level unit	dBm
Sweep time	auto
Resolution bandwidth	auto (3 MHz)
Video bandwidth	auto (10 MHz)
FFT filters	off
Span / RBW	50
RBW / VBW	0.33
Sweep	cont
Trigger	free run
Trace 1	clr write
Trace 2/3	blank
Detector	auto peak
Trace math	off
Frequency offset	0 Hz
Reference level offset	0 dB
Reference level position	100 %
Grid	abs
Cal correction	on
Noise source	off
Input	RF
Display	Full screen, active screen A
Tracking generator (only with option FSP-B9)	off
External generator 1/2 (only with option FSP-B10)	off
Preamplifier (only with option ESPI-B2)	off
Preselector (only with option ESPI-B2)	off

## Mode Selection – *HOTKEY* Bar

For fast mode selection ESPI has seven keys (the so-called *HOTKEYS*) which can be allocated depending on the options installed on the instrument.

Three keys are reserved for the basic model:

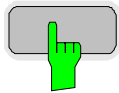
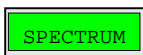
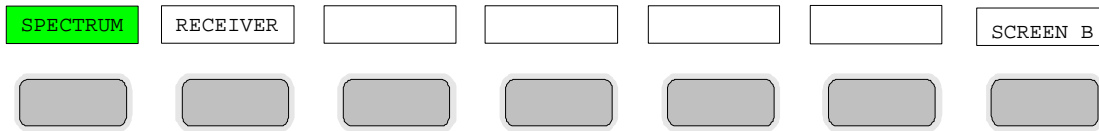

The *SPECTRUM* hotkey sets ESPI to spectrum analysis mode.

The spectrum analysis mode is the basic setting of ESPI.

IEC/IEEE-bus command: `INST:SEL SAN`

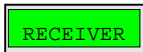

The *RECEIVER* hotkey sets the ESPI in the test receiver mode.

IEC/IEEE-bus command: `INST:SEL REC`

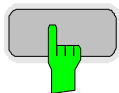
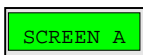

With the *SCREEN A* / *SCREEN B* hotkey two different settings can be selected on the ESPI in the FULL SCREEN mode.

In the SPLIT SCREEN mode the key switches between active diagram A and B.

The key designation indicates the diagram which has been activated by means of the key.

The currently active window is marked by **A** or **B** on the right of the diagram.

IEC/IEEE-bus command: `DISP:WIND<1|2>:SEL`

The meaning of the other keys is described in the chapter describing the various options.



## Return to manual control – LOCAL Menu

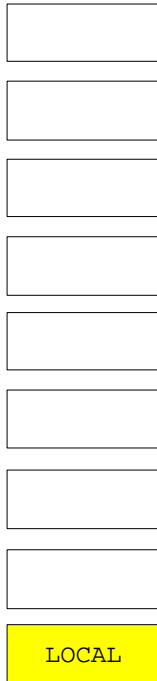

The menu LOCAL is displayed on switching the instrument to remote control mode.

At the same time, the *HOTKEY* bar is blanked out and all keys are disabled except the *PRESET* key. The diagram, traces and display fields are then blanked out (they can be activated using the remote control command `SYSTEM:DISPlay:UPDate ON`).

The menu contains only one softkey, the *LOCAL* key. The *LOCAL* key switches the instrument from remote to manual control, with the assumption that the remote controller has not previously set the *LOCAL LOCKOUT* function.

A change in the control mode consists of:

- **Enabling the Front Panel Keys**

Returning to manual mode enables all inactive keys and turns on the hotkey menu. The softkey menu which is displayed is the main menu of the current mode.

- **Inserting the measurement diagrams**

The blanked diagrams, traces and display fields are inserted.

- **Generating the message OPERATION COMPLETE**

If, at the time of pressing the *LOCAL* softkey, the synchronisation mechanism via *\*OPC*, *\*OPC?* or *\*WAI* is active, the currently running measurement procedure is aborted and synchronisation is achieved by setting the corresponding bits in the registers of the status reporting system.

- **Setting Bit 6 (User Request) of the Event Status Register**

With a corresponding configuration of the status reporting system, this bit immediately causes the generation of a service request (*SRQ*) which is used to inform the control software that the user wishes to return to front-panel control. This information can be used, e.g., to interrupt the control program so that the user can make necessary manual corrections to instrument settings. This bit is set each time the *LOCAL* softkey is pressed.

**Note:** *If the LOCAL LOCKOUT function is active in the remote control mode, the front-panel PRESET key is also disabled. The LOCAL LOCKOUT state is left as soon as the process controller deactivates the REN line or the IEC/IEEE-bus cable is disconnected from the instrument.*

## RECEIVER Mode

The mode is selected using the *RECEIVER* hotkey (see also section "Mode Selection")

*RECEIVER* menu:

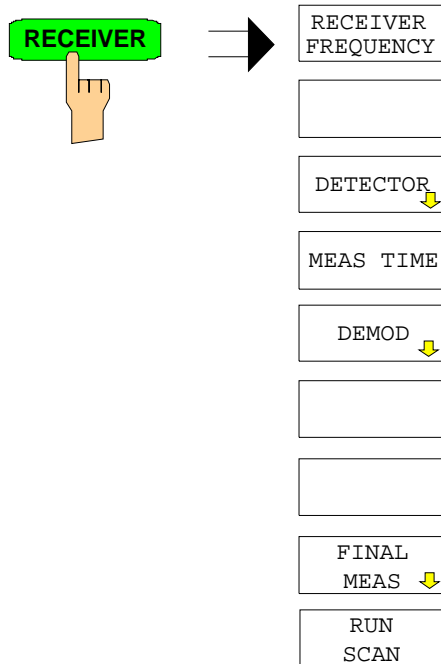

The *RECEIVER* hotkey selects the receiver mode (RFI reception) and activates the menu for setting the receiver parameters.

For description of the softkeys see the following menus:

<i>RECEIVER FREQUENCY</i>	<i>FREQ</i> menu, page 4.6
<i>DETECTOR</i>	<i>MEAS</i> menu, page 4.16
<i>MEAS TIME</i>	<i>MEAS</i> menu, page 4.18
<i>DEMOD</i>	<i>MEAS</i> menu, page 4.20
<i>FINAL MEAS</i>	<i>MEAS</i> menu, page 4.21
<i>RUN SCAN</i>	<i>SWEEP</i> menu, page 4.45

IEC/IEEE-bus command           :INST REC

In the receiver mode, ESPI acts as a test receiver, i.e. it measures the level at the set frequency with a selected bandwidth and measurement time (*RES BW* and *MEAS TIME* softkeys). Signal weighting is by means of the average, max peak, min peak, RMS and quasi-peak detectors (*DETECTOR* softkey).

The functions for data reduction and the control of line impedance simulating network are available in the *FINAL MEAS* sub menu.

A frequency scan can be performed after setting the start and stop frequency and the step width. The scan subranges can be defined in a table (*DEFINE SCAN* softkey).

The scan is started with the *RUN SCAN* softkey. In operating mode *RECEIVER*, the *RECEIVER* hotkey directly opens the *RECEIVER* menu.

The ESPI can be extended by a preselection with switchable preselection (option Preselector ESPI-B2). When the option is installed, preselection is always switched on in receiver mode.

## Operation on a Discrete Frequency

### Setting the Receive Frequency and the Scan Range

The *FREQ* key opens the *FREQUENCY* menu for setting the receive frequency in manual mode and the frequency axis for scan display.

*FREQ* menu

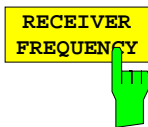
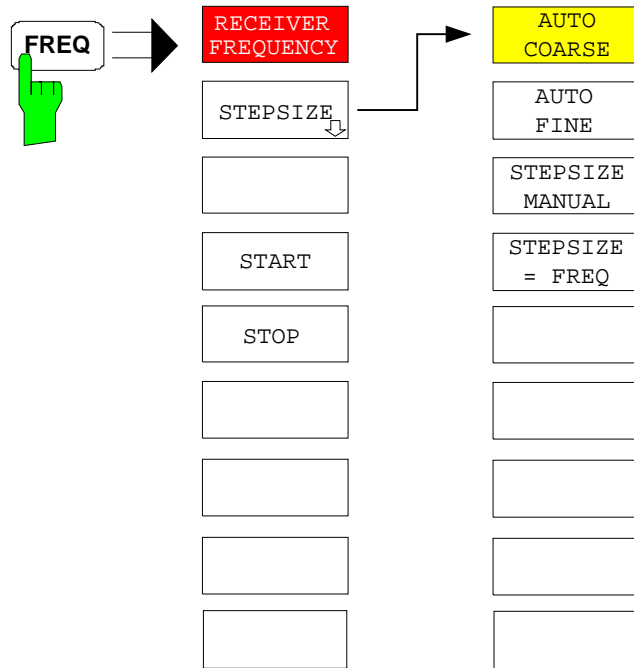

The *RECEIVER FREQUENCY* softkey activates the entry field of the receive frequency.

The tuning frequency has to be set to at least twice the IF bandwidth.

When the tuning frequency is lower than twice the IF bandwidth, the IF bandwidth is automatically reduced so that this condition is met again.

If the frequency is increased again, the original IF bandwidth is restored (memory function). The memory is cleared when the IF bandwidth is manually changed.

The resolution of the receive frequency is always 0.1 Hz.

Range:  $9 \text{ kHz} \leq f_{\text{rec}} \leq f_{\text{max}}$

**Note:** This softkey is also available in the *RECEIVER* menu.

IEC/IEEE-bus command :FREQ:CENT 300 MHz

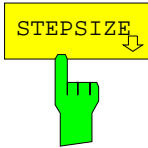

The *STEPSIZE* opens a sub menu for setting the step size of the receive frequency. The step size can be coupled to the set frequency or be manually set to a fixed value. The softkeys of the submenu are mutually exclusive selection switches. Only one switch can be activated at any one time.



If the *AUTO COARSE* softkey is activated, the receive frequency is set in coarse steps. The 4th digit of the selected frequency is varied.

IEC/IEEE-bus command      --

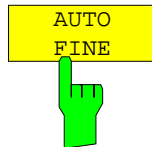

If the *AUTO FINE* softkey is activated, the receive frequency is set in fine steps. The 7th digit of the selected frequency is varied.

IEC/IEEE-bus command      --



The *STEPSIZE MANUAL* softkey activates the entry window for the input of a fixed step size.

IEC/IEEE-bus command      `FREQ:CENT:STEP 50 kHz`

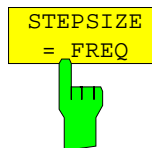

The *STEPSIZE = FREQ* softkey sets the step size to a value equal to the receive frequency.

This function is especially useful during measurements of the signal harmonic content, because, when entering the receiver frequency, the receiver frequency of another harmonic is selected with each stroke of the *STEP* key.

IEC/IEEE-bus command      --

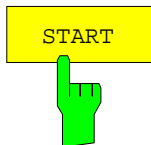

The *START* softkey opens a window where the start frequency of the scan diagram can be entered.

The permissible value range for the start frequency is:

$$f_{\min} \leq f_{\text{start}} \leq f_{\max} - 10 \text{ Hz}$$

$f_{\text{start}}$     start frequency  
 $f_{\max}$         maximum frequency

IEC/IEEE bus command    :`FREQ:STAR 20 MHz`

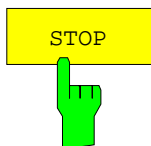

The *STOP* softkey opens a window where the stop frequency of the scan diagram can be entered.

The permissible value range for the stop frequency is:

$$f_{\min} + 10 \text{ Hz} \leq f_{\text{stop}} \leq f_{\max}$$

$f_{\text{stop}}$     stop frequency  
 $f_{\max}$         maximum frequency

IEC/IEEE bus command    :`FREQ:STOP 2000 MHz`

## Level Display and RF Input Configuration – AMPT Key

The *AMPT* key is used to set the input attenuation, the preamplifier (only with option ESPI-B2), the auto range function and the display unit.

In addition, the level display range for the scan can be set.

*AMPT* menu:

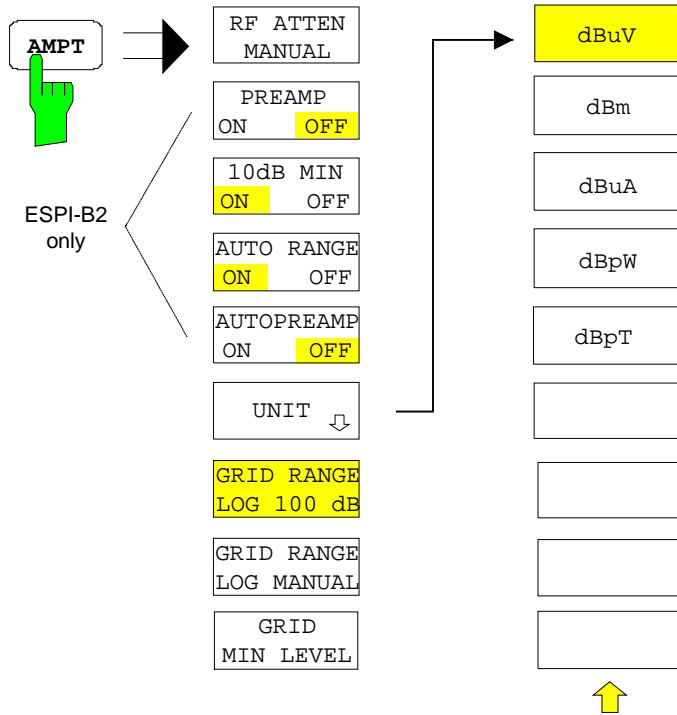

The *RF ATTEN MANUAL* softkey activates the attenuation entry field.

The attenuation can be set between 0 and 70 dB in 10 dB steps. Other entries are rounded to the next higher integer.

**Note:** To protect the input mixer against inadvertent overload, 0 dB can only be switched on when function 10 dB MIN is switched off.

IEC/IEEE-bus command      INP:ATT 40 DB

## Preamplifier

When equipped with option ESPI-B2, Preselector, ESPI is provided with a switchable preamplifier of 20 dB gain in the frequency range up to 3 GHz.

Switching on the preamplifier reduces the total noise figure of ESPI and thus improves the sensitivity. The disadvantage of a poorer large-signal immunity (intermodulation) is reduced by the connected preselector. The signal level of the subsequent mixer is 20 dB higher so that the maximum input level is reduced by the gain of the preamplifier. The total noise figure of ESPI is reduced from approx. 18 dB to approx. 10 dB when a preamplifier is used. The use of the preamplifier is recommended when measurements with a maximum sensitivity are to be performed. On the other hand, if the measurement should be performed at maximum dynamic range, the preamplifier should be switched off.

The gain of the preamplifier is automatically considered in the level display. The preamplifier follows the preselection filters so that the risk of overdriving by strong out-of-band signals is reduced to a minimum.

### CONFIGURATION MODE - RECEIVER menu

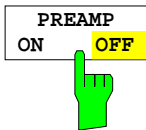

The *PREAMP ON/OFF* softkey switches the preamplifier (9 kHz to 3 GHz) on and off.

Default value is OFF.

The softkey is only available when the ESPI is equipped with option ESPI-B2, Preselector.

IEC/IEEE-bus command : INP : GAIN : STAT ON | OFF

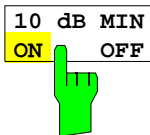

The *10 DB MIN* softkey determines whether the 10 dB setting of the attenuator may be used in the manual or automatic setting of the attenuator.

*10 DB MIN ON* is the default value, i.e. an RF attenuation of at least 10 dB is always set on ESPI to protect the input mixer.

An attenuation of 0 dB cannot be set manually either. This avoids 0 dB being switched on inadvertently particularly when DUTs with high RFI voltage are measured.

IEC/IEEE-bus command : INP : ATT : PROT ON | OFF

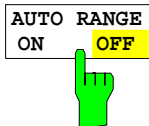

The *AUTO RANGE ON/OFF* softkey switches the autorange function on and off.

ON The attenuation is automatically set so that a good S/N ratio is obtained without the receiver stages being overdriven.

OFF The attenuation is set manually.

IEC/IEEE-bus command : INP : ATT : AUTO ON | OFF

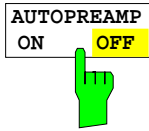

The *AUTOPREAMP ON/OFF* softkey switches the autopreamp function and or off.

**ON** The preamplifier is considered in the autorange procedure. The preamplifier is cut in when the RF attenuation is reduced to the minimum settable value.

**OFF** The preamplifier is not considered in the autorange procedure.

The softkey is only available when the ESPI is equipped with option ESPI-B2, Preselector.

IEC/IEEE-bus command : INP:GAIN:AUTO ON | OFF

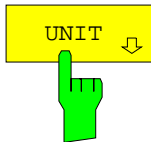

- dBuV
- dBm
- dBuA
- dBpW
- dBpT
- 
- 
- 
- 

The *UNIT* key opens a submenu in which the desired units for the level axis can be selected.

Default setting is dBμV.

In general, a receiver measures the signal voltage at the RF input. The level display is calibrated in rms values of an unmodulated sine wave signal. Via the known input resistance of 50 Ω a conversion can be made to other units. The units dBm, dBμA, dBpW, and dBpT are directly convertible.

IEC/IEEE-bus command CALC:UNIT:POW DBM

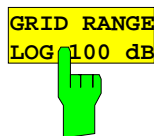

The *GRID RANGE LOG 100 dB* softkey sets the level display range for the scan diagram to 100 dB (= default setting).

IEC/IEEE-bus commands DISP:WIND:TRAC:Y:SPAC LOG  
DISP:WIND:TRAC:Y 100DB



The *GRID RANGE LOG MANUAL* softkey activates the entry of the level display range for the scan diagram.

The display ranges go from 10 to 200 dB in 10-dB steps. Invalid entries are rounded off to the nearest valid value.

IEC/IEEE bus commands DISP:WIND:TRAC:Y:SPAC LOG  
DISP:WIND:TRAC:Y 120DB



The *GRID MIN LEVEL* softkey activates the entry of the minimum level of the display range. Allowed values are:

$$- 200 \leq \text{GRID MIN LEVEL} \leq + 200 \text{ dB - GRID RANGE}$$

IEC/IEEE bus commands DISP:WIND:TRAC:Y:SPAC LOG  
DISP:WIND:TRAC:Y:BOTT 0DBM

## Setting the IF Bandwidth - BW Key

ESPI offers the IF bandwidths (3 dB bandwidths) from 10 Hz to 10 MHz available in steps of 1/3/10 and the IF bandwidths (6 dB bandwidths) 200 Hz, 9 kHz, 120 kHz and 1 MHz.

The resolution bandwidths up to 120 kHz are implemented by digital Gaussian bandpass filters. As far as attenuation characteristic is concerned, they behave like analog filters, but they have a much higher measurement speed than comparable analog filters. This is due to the fact that the transient response can be compensated because the filters have an accurately defined behavior.

Bandwidths of 300 kHz and higher are implemented by decoupled LC filters. These filters contain 4 filter circuits.

BW menu:

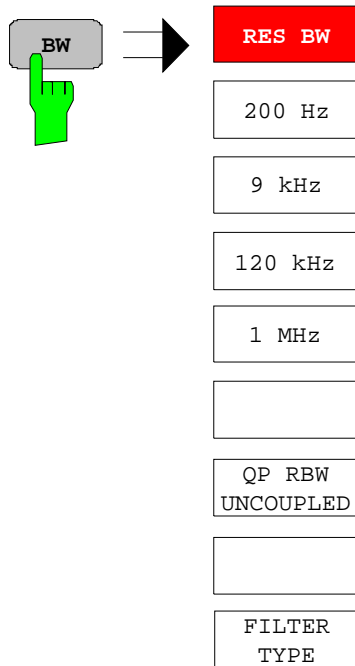

The *BW* opens the menu for setting the resolution bandwidth.



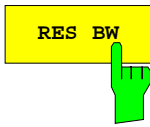

The *RES BW* softkey activates the manual entry mode for the resolution bandwidth.

For filter type NORMAL (3dB), the bandwidth can be set from 10 Hz to 10 MHz in steps of 1/3/10. For filter type NORMAL (6dB), the 6-dB bandwidth 200 Hz, 9 kHz, 120 kHz and 1 MHz can be set.

For numerical inputs, the values are always rounded to the next valid bandwidth. For rollkey or the UP/DOWN key entries, the bandwidth is adjusted in steps either upwards or downwards.

For the CHANNEL and RRC filter types, the bandwidth is selected from a list of available channel filters, which is included at the end of this section. The list can be scrolled with the ↑ and ↓ keys to select a filter (see section "List of Available Channel Filters").

When the quasi-peak detector is switched on, a fixed bandwidth is preset depending on the frequency. The coupling of the IF bandwidth to the frequency range with activated quasi peak detector can be cancelled using the *QP RBW UNCOUPLED* softkey (see below).

The bandwidth is limited by the set receive frequency:

$$\text{RES BW} \leq f_{in} / 2$$

IEC/IEEE-bus command      BAND 1 MHz

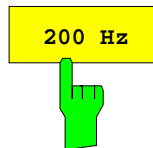

The *200 Hz* softkey sets the CISPR bandwidth 200 Hz.

IEC/IEEE-bus command      BAND 200 Hz

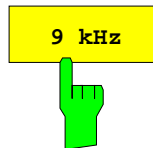

The *9 kHz* softkey sets the CISPR bandwidth 9 kHz.

IEC/IEEE-bus command      BAND 9 kHz

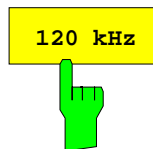

The *120 kHz* softkey sets the CISPR bandwidth 120 kHz.

IEC/IEEE-bus command      BAND 120 kHz

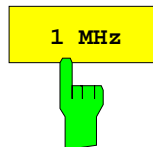

The *1 MHz* softkey sets the 6-dB bandwidth 1 MHz.

IEC/IEEE-bus command      BAND 1 MHz

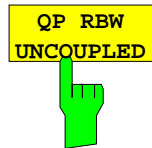

The *QP RBW UNCOUPLED* softkey cancels the coupling of the IF bandwidth to the frequency range with activated quasi peak detector. If the coupling is cancelled, any of the three CISPR bandwidths 200 Hz, 9 kHz, 120 kHz can be selected for a given frequency range.

IEC/IEEE-bus command BAND:AUTO ON

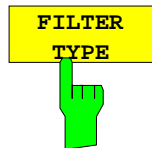

The *FILTER TYPE* softkey opens a list of available filter types. Gaussian bandpass filters of 3 dB and 6 dB bandwidth as well as channel filters are available.

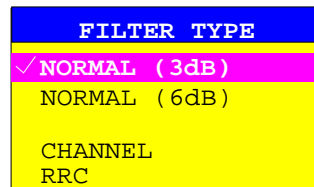

**NORMAL(3dB)** The resolution bandwidths are implemented by Gaussian filters with the set 3 dB bandwidth and correspond approximately to the noise bandwidth. For bandwidths up to 100 kHz, digital bandpass filters are used.

IEC/IEEE-bus command BAND:TYPE NOIS  
BAND:TYPE NORM

**NORMAL(6dB)** The resolution bandwidths are implemented by Gaussian filters with the set 6 dB bandwidth and correspond approximately to the pulse bandwidth. For bandwidths up to 120 kHz, digital bandpass filters are used.

IEC/IEEE-bus command BAND:TYPE PULS

Moreover, several particularly steep-edged channel filters are available for power measurements.

There are two types of filter:

CHANNEL = steep-edged channel filters

IEC/IEEE-bus command: BAND:TYPE CFIL

RRC = Root Raised Cosine filters

IEC/IEEE-bus command: BAND:TYPE RRC

**List of Available Channel Filters**

The channel filters included in the following table are available as resolution filters (softkey *RES BW*) after activation with softkey *FILTER TYPE*. The channel filters  $\geq 2.0$  MHz are only available for instruments equipped with a model  $\geq 3$  of the IF FILTER module (see column *MODEL* in *HARDWARE INFO* table, *SETUP SYSTEM INFO* menu)

**Note:** For filter type *RRC* (Root Raised Cosine) the filter bandwidth indicated describes the sampling rate of the filter.  
For all other filters (*CFILter*), the filter bandwidth is the 3-dB bandwidth.

Filter Bandwidth	Filter Type	Application
100 Hz 200 Hz 300 Hz 500 Hz	CFILter CFILter CFILter CFILter	A0
1 kHz 1.5 kHz 2 kHz 2.4 kHz 2.7 kHz 3 kHz 3.4 kHz 4 kHz 4.5 kHz 5 kHz 6 kHz 8.5 kHz 9 kHz	CFILter CFILter CFILter CFILter CFILter CFILter CFILter CFILter CFILter CFILter CFILter CFILter CFILter	SSB  DAB, Satellite  ETTS300 113 (12.5 kHz channels) AM Radio
10 kHz 12.5 kHz 14 kHz 15 kHz 16 kHz 18 kHz, $\alpha=0.35$ 20 kHz 21 kHz 24.3 kHz, $\alpha=0.35$ 25 kHz 30 kHz 50 kHz	CFILter CFILter CFILter CFILter RRC CFILter CFILter RRC CFILter CFILter CFILter	CDMAone ETTS300 113 (20 kHz channels) ETTS300 113 (25 kHz channels) TETRA PDC IS 136 CDPD, CDMAone
100 kHz 150 kHz 192 kHz 200 kHz 300 kHz 500 kHz	CFILter CFILter CFILter CFILter CFILter CFILter	FM Radio PHS  J.83 (8-VSB DVB, USA )
1.0 MHz 1.2288 MHz 1.5 MHz 2.0 MHz* 3.0 MHz* 3.84 MHz, $\alpha=0.22^*$ 4.096 MHz, $\alpha=0.22^*$ 5.0 MHz*	CFILter CFILter CFILter CFILter RRC RRC CFILter	CDMAone CDMAone DAB  W-CDMA 3GPP W-CDMA NTT DOCMo

\*) requires IF filter model index  $\geq 3$

## Selection of the Measurement Function – MEAS Key

The MEAS key opens the menu to select the detectors and set the measurement time for the receiver and the audio demodulator.

To reduce the amount of data in RFI voltage measurements, a list of subrange maxima (softkey *PEAK SEARCH*) can be generated from the scan results and an acceptance line (softkey *MARGIN*) may be defined in submenu *FINAL MEAS*. A final measurement is performed only for frequencies with high RFI level.

The final measurement may be either automatic (softkey *AUTOMATIC FINAL*) or in interactive mode (softkey *INTERACTIVE*). Automatic control functions for line impedance stabilization networks (softkey *LISM*) are available in the side menu. The final measurement is started with the softkey *RUN FINAL MEAS*.

MEAS menu:

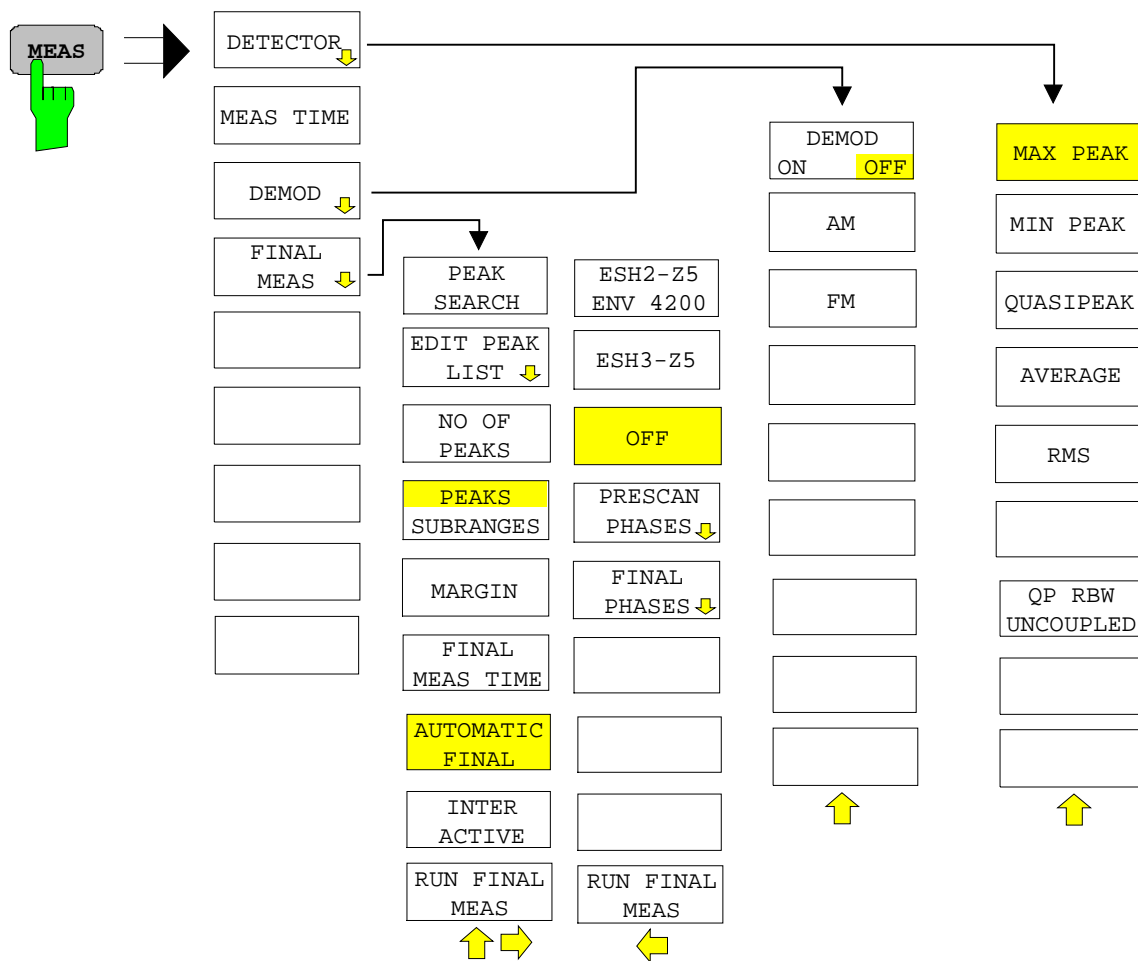

## Selecting the Detector

Five different detectors can be selected for weighting the receive signal.

- The max peak detector yields the largest sample values of the levels measured during the set measurement time.
- The min peak detector yields the smallest sample values of the levels measured during the set measurement time.
- The average detector yields the average level of the samples measured during the set measurement time.
- The rms detector yields the rms level of the samples measured. The integration time corresponds to the set measurement time.
- The quasi-peak detector yields the maximum detected value weighted to CISPR 16. Depending on the set frequency, the ESPI automatically selects the detectors and IF bandwidths defined for bands A, B and C/D listed in the following table:

	Band A	Band B	Band C/D
<b>Frequency range</b>	< 150 kHz	150 kHz to 30 MHz	> 30 MHz
<b>IF bandwidth</b>	200 Hz	9 kHz	120 kHz
<b>Charge time constant</b>	45 ms	1 ms	1 ms
<b>Discharge time constant</b>	150 ms	500 ms	550 ms
<b>Time constant of instrument</b>	160 ms	160 ms	100 ms

For frequencies above 1 GHz, the ESPI uses the 120 kHz bandwidth of band C/D.

The coupling of the IF bandwidth to the frequency range with activated quasi peak detector can be cancelled using the *QP RBW UNCOUPLED* softkey.

- The input signal of ESPI can be displayed weighted by three detectors simultaneously.

Multiple detection is important in EMI measurements since, for example, civil standards specify limits for both the quasi-peak and the average value. Thanks to the multiple use of detectors, only one test run is needed. The peak detector can be combined with any other detector since it is the fastest detector and therefore ideal for overview measurements.

DETECTOR menu:

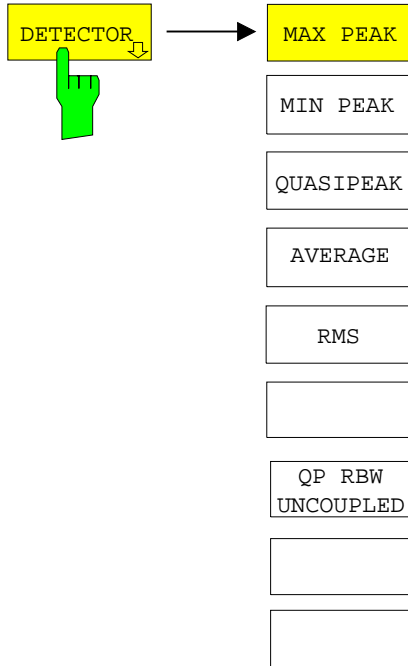

The *DETECTOR* softkey opens a submenu to select the detector and combinations of detectors.

A maximum of three detectors can be switched on simultaneously.

**Note:** This softkey is also available in the Receiver-menu.



The *MAX PEAK* softkey activates the max peak detector.

IEC/IEEE-bus command     DET:REC POS



The *MIN PEAK* softkey activates the min peak detector.

IEC/IEEE-bus command     DET:REC NEG



The *QUASIPeAK* softkey selects the quasi-peak detector.

The IF bandwidth is adapted as a function of the frequency range. The coupling of the IF bandwidth to the frequency range can be cancelled using softkey *QP RBW UNCOUPLED*.

IEC/IEEE-bus command     DET:REC QPE

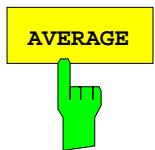

The *AVERAGE* softkey activates the average detector.

IEC/IEEE-bus command     DET:REC AVER

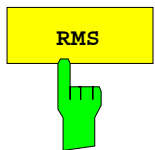

The *RMS* softkey activates the rms detector.

IEC/IEEE-bus command     DET:REC RMS

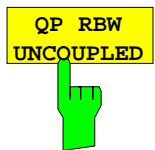

The *QP RBW UNCOUPLED* softkey cancels the coupling of the IF bandwidth to the frequency range with activated quasi peak detector.

IEC/IEEE-bus command     BAND:AUTO OFF

## Setting the Measurement Time

The measurement time can be set in steps of 1-2-5 in the range 100  $\mu$ s to 100 s. A measurement time of 15 s is available in addition.

The measurement time is the time during which ESPI measures the input signal and forms a measurement result weighted by the selected detector. The measurement time does not include settling times of the synthesizer and the IF filter. ESPI automatically waits until transients are over. When the quasi-peak detector is used, the minimum measurement time is 1 ms.

With the average, RMS, AC video or min/max peak detector the smallest settable measurement time depends on the bandwidth.

Bandwidth	Shortest measurement time AV, RMS	Shortest measurement time PK+, PK-
$\leq 10$ Hz	1 sec	10 msec
100 Hz	100 msec	1 msec
200 Hz	50 msec	1 msec
1 kHz	10 msec	0,1 msec
9 kHz	1 msec	0,1 msec
$\geq 100$ kHz	0,1 msec	0,05 msec

RECEIVER menu

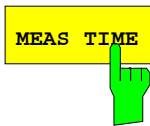

The *MEAS TIME* softkey activates the entry field for the measurement time.

**Note:** This softkey is also available in the Receiver menu.

IEC/IEEE-bus command      SWE:TIME 100ms

### Effect of measurement time with different weighting modes:

MIN/MAX PEAK measurement:

With peak weighting selected, the maximum or minimum level during the selected measurement time is displayed. The peak detector is reset at the beginning of each measurement. At the end of the measurement time the maximum or minimum level occurred during the measurement time is displayed. Since the peak detector of ESPI is a digital detector, discharging is irrelevant even with long measurement times.

Unmodulated signals can be measured with the shortest possible measurement time. When pulses are measured, the selected measurement time must be long enough for at least one pulse to occur during the measurement time.

Average measurement:	With average detection selected, the video voltage (envelope of IF signal) is averaged during the measurement time. Averaging is digital, i.e. the digitized values of the video voltage are summed up and divided by the number of samples at the end of the measurement time. This corresponds to a filtering with a rectangular window in the time domain and a filtering with $\sin x/x$ characteristic in the frequency domain. With unmodulated signals the shortest possible measurement time can be selected. With modulated signals the measurement time is determined by the lowest modulation frequency to be averaged. With pulse signals, the selected measurement time should be long enough for sufficient number of pulses ( $>10$ ) to occur in the measurement window for averaging.
RMS measurement:	With RMS weighting the same applies to the measurement time as with the average measurement.
Quasi-peak measurement:	<p>With quasi-peak measurements, the maximum value of the weighted signal during the measurement time is displayed. The relatively long time constants used with quasi-peak detectors entail long measurement times to obtain correct results. With unknown signals the measurement time should be at least 1 s. This ensures correct weighting of pulses down to a pulse frequency of 5 Hz.</p> <p>After internal switching, ESPI waits until the measurement result has stabilized before it starts the actual measurement. Since the level does not change during a frequency scan, known signals (e.g. broadband RFI) can be correctly measured with a much shorter measurement time.</p>
Measurement with several detectors:	If several detectors are used simultaneously, a measurement time suiting the slowest detector should be selected to obtain correct results for all detectors. It is therefore recommended to set a measurement time that matches the average detector when the peak and average detectors are used.



## AF Demodulators

ESPI provides demodulators for AM and FM signals. With these demodulators selected, a displayed signal can be monitored using the internal loudspeaker or external headphones.

DEMODO menu:

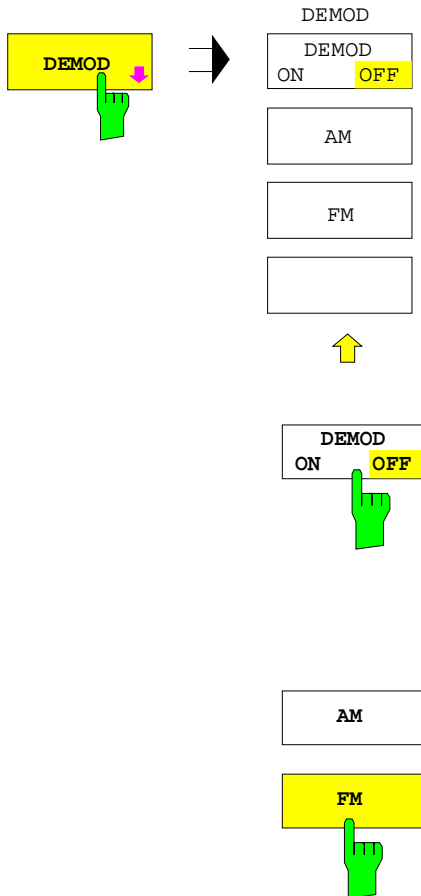

The *DEMODO* softkey calls a submenu in which the desired type of demodulation can be switched on.

The volume for loudspeaker and headphones is set by means of control knob on the front panel. The volume can also be remote-controlled (IEC/IEEE-bus command `SYST:SPE:VOL 0.7`).

**Note:** This softkey is available also in the *RECEIVER* menu.

The *DEMODO ON/OFF* softkey switches demodulation on/off.

IEC/IEEE-bus command `DEM OFF`  
 (DEModulation ON automatically switched on with `DEM AM | FM`)

The *AM* and *FM* softkeys can be activated one at a time. They are used to set the desired demodulation type, FM or AM. .

IEC/IEEE-bus command `DEM AM | FM`

## Data Reduction and Peak List

EMI measurements may involve much time because the time constants prescribed by the standard for the quasi-peak weighting require transients which lead to long measurement times per each value. In addition, the standards stipulate procedures for finding local EMI maxima such as shifting the absorbing clamp, variation of the test antenna height and rotating the DUT. Measuring with quasi-peak weighting at each frequency and for each setting of the test configuration would lead to unacceptably long measurement times. For this reason, R&S has developed a method which reduces the time-consuming measurements to a minimum with an optimum reliability of detection.

The interference spectrum is first pre-analyzed in a fast prescan to optimize the duration of the measurement. Data reduction follows so that the time-consuming final measurement is performed at only some important frequencies:

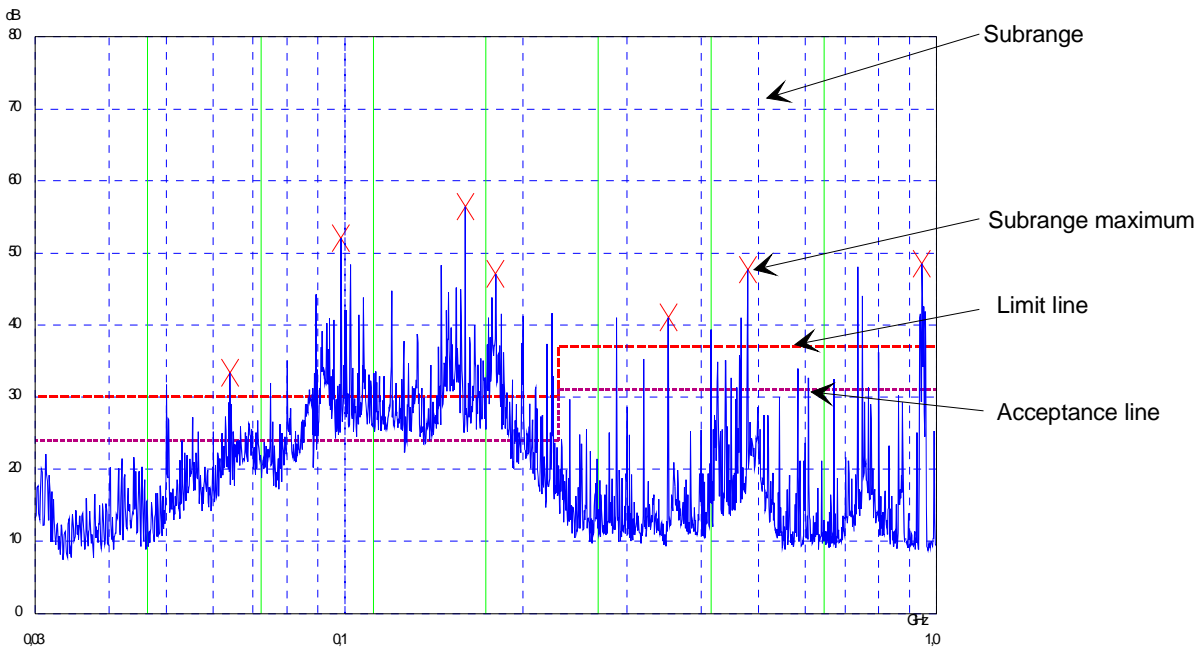

Fig. 4-1 Dividing the spectrum into eight subranges

Data reduction is of crucial importance. It is initiated by the user pressing a key after the prescan and then automatically performed by the receiver. Data reduction is used to select frequencies with a very high interference level. Several data reduction methods are used:

- Acceptance analysis, i.e. the interference spectrum is further analyzed at frequencies with levels above a line parallel to a limit line.
- Generating subrange maxima, i.e. the interference spectrum is further analyzed at frequencies with the highest interference level of a frequency subrange (search method SUBRANGES).
- Determination of a specific number of peak values relative to the limit lines with the level values being independent of their frequency spectral distribution (search method PEAKS).

For generation of subrange maxima, the whole frequency range is divided into equidistant subranges. A subrange maximum is determined for each subrange (search method SUBRANGES).

Determining the level maxima irrespective of their distribution in the frequency spectrum (search mode PEAKS) is suitable for measurement regulations that demand determination of the relatively highest level irrespective of the distribution in the measured frequency range, e.g. FCC.

If the prescan is performed in parallel with several detectors, typically with peak value and average value, the maxima are determined separately for the two detectors so that the distribution of narrowband and wideband sources of interference can be taken into account. For example, the frequency of the maximum determined with the average detector can be used for the final measurement performed with this detector and the frequency found in the prescan carried out with the peak detector is taken for the final measurement using the quasi-peak detector.

Consideration of the limit lines ensures that the final measurement is not performed at frequencies at which the inference level is far below the limit value. The margin between the acceptance line and the limit line can be selected by the user in dB as the *MARGIN*. Each limit line is allocated to a trace, i.e. different limit lines are taken for the different detectors.

Two values should therefore be defined for this purpose:

- the number of subranges or highest level values (*NO OF PEAKS* in the range from 1 to 500; default value: 25)
- the acceptance margin (*MARGIN*; default value: 6 dB). It is valid for all limit lines.

As an alternative method, it is possible to preset a list of frequencies at which the final measurements are performed. A typical application is, for example, the statistical analysis of several units.

The peak list can be either edited manually or can be filled with desired values by adopting the marker values.

If no limit lines are activated, the measurement procedure is as if all measured values would exceed the limit line.

FINAL MEAS menu (left side menu)

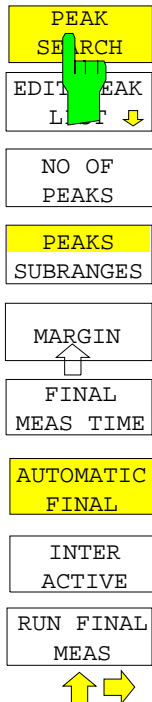

The *PEAK SEARCH* softkey starts the determination of the subrange maxima list from the available scan results. The procedure can be repeated as often as desired to try out different settings of margin and number of subranges.

IEC/IEEE-bus command : CALC : PEAK

The following table shows the peak list which is determined by the peak-search function after the prescan:

EDIT PEAK LIST (Prescan results)			
Trace1: 014QP			
Trace2: 014AV			
TRACE3: ---			
TRACE	FREQUENCY	LEVEL dBpT	DELTA LIMIT dB
1 Average	80.0000 MHz	35.34	-3.91
2 Average	89.4800 MHz	38.83	-0.91
1 Max Peak	98.5200 MHz	47.53	-2.63
2 Average	98.5200 MHz	46.63	6.47
1 Max Peak	100.7200 MHz	54.14	3.88
2 Average	102.3200 MHz	50.89	10.56
1 Max Peak	113.2400 MHz	49.68	-1.08
2 Average	116.9200 MHz	44.81	3.91
1 Max Peak	125.8800 MHz	55.01	3.78
2 Average	125.8800 MHz	53.55	12.33
1 Max Peak	138.4800 MHz	45.68	-5.95
2 Average	138.4800 MHz	42.17	0.53
2 Average	144.0400 MHz	43.72	1.90
2 Average	167.0400 MHz	44.77	2.32
2 Average	176.2400 MHz	45.52	2.83
1 Max Peak	200.4800 MHz	52.49	-0.75
2 Average	200.4800 MHz	48.76	5.51
1 Max Peak	210.2800 MHz	60.55	7.09
2 Average	226.5600 MHz	59.02	15.24
2 Average	239.0000 MHz	48.59	4.75

FINAL MEAS menu (left side menu)

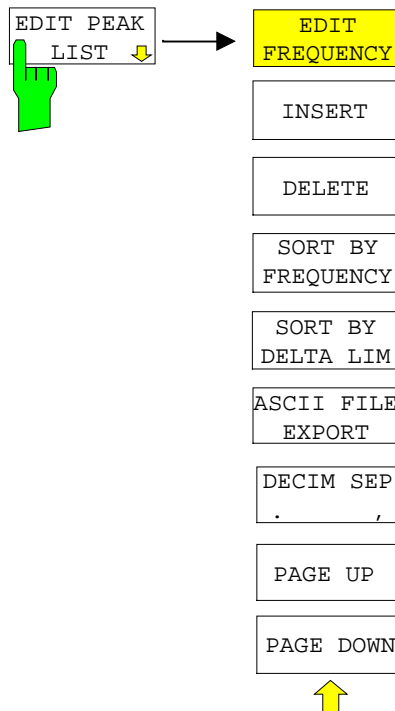

The *EDIT PEAK LIST* softkey calls the *EDIT PEAK LIST* submenu used for editing the peak list. A frequency list can thus be predefined and a final measurement carried out at these frequencies.

A peak list can also be generated by adopting the marker values (see section "Changing the device settings with Markers marker →")

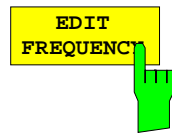

The *EDIT FREQUENCY* softkey activates table *EDIT PEAK LIST*. The cursor marks the upper field of column *FREQUENCY*.

IEC/IEEE-bus command      --

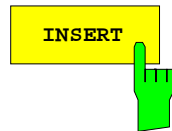

The *INSERT* softkey creates an empty line above the current cursor position

IEC/IEEE-bus command      --

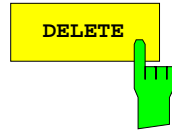

The *DELETE* softkey erases the complete line at the cursor position. Before deletion, a message appears requesting confirmation..

IEC/IEEE-bus command      --

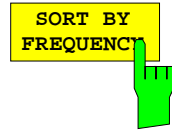

The softkey *SORT BY FREQUENCY* sorts the table in a descending order according to the entries in the *FREQUENCY* column.

IEC/IEEE-bus command      --



The softkey *SORT BY DELTA LIMIT* sorts the table in a descending order according to the entries in the *DELTA LIMIT* column .

IEC/IEEE-bus command      --



The *ASCII FILE EXPORT* softkey stores the final measurement data in a file with ASCII format on a floppy disk.

IEC/IEEE command `FORM ASC;`  
`MMEM:STOR:FIN 1,'FINAL.DAT'`

The file consists of the header containing important scaling parameters, several data sections containing the scan settings and a data section containing the results of the final measurement.

The data of the file header consist of three columns, each separated by a semicolon:  
 parameter name; numeric value; basic unit

The data section for the trace data starts with the keyword "Trace <n> Final" (<n> = number of stored trace), followed by the measured data in one or several columns which are also separated by a semicolon.

This format can be read in from spreadsheet calculation programs, e.g. MS-Excel. It is necessary to define ';' as a separator.

**Note:** *Different language versions of evaluation programs may require a different handling of the decimal point. It is therefore possible to select between separators '.' (decimal point) and ',' (comma) using softkey DECIM SEP.*

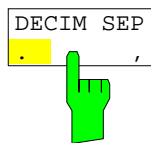

The *DECIM SEP* softkey selects the decimal separator between '.' (decimal point) and ',' (comma) with floating-point numerals for the function ASCII FILE EXPORT.

With the selection of the decimal separator different language versions of evaluation programs (e.g. MS-Excel) can be supported.

IEC/IEEE-bus command `FORM:DEXP:DSEP POIN`

## Structure of the ASCII file:

RECEIVER mode, final measurement data:

	Content of file	Description
<b>File header</b>	Type;ESPI 7;	Instrument model
	Version;1.18;	Firmware version
	Date;02.Aug 2001;	Date record storage date
	Mode;Receiver;	Instrument operating mode
	Start;10000;Hz	Start/stop of the display range.
	Stop;100000;Hz	Unit: Hz
	x-Axis;LIN;	Scaling of x axis linear (LIN) or logarithmic (LOG)
	Scan Count;1;	Number of scans set
	Transducer;TRD1;	Transducer name (if switched on)
	Scan 1:	Loop over all defined scan ranges (1-10)
	Start;150000;Hz	Range - start frequency in Hz
	Stop;1000000;Hz	Range - stop frequency in Hz
	Step;4000;Hz	Range - step width in Hz for linear step width or in % (1-100) for logarithmic step width
	RBW;100000;Hz	Range - resolution bandwidth
	Meas Time;0.01;s	Range - measurement time
	Auto Ranging;ON;	Auto ranging on - or off for current range
	RF Att;20;dB	Range - input attenuation
Auto Preamp;OFF;	Auto Preamp on or off for current range	
Preamp;0;dB	Range - preamplifier on (20dB) or off (0dB)	
<b>Data section of the file</b>	TRACE 1 FINAL:	Selected trace
	Trace Mode;CLR/WRITE;	Trace mode: CLR/WRITE,AVERAGE,MAX HOLD,MIN HOLD,VIEW, BLANK
	Final Detector, QUASI PEAK;	Final detector MAX PEAK, MIN PEAK, RMS, AVERAGE, QUASI PEAK, AC VIDEO
	x-Unit;Hz;	Unit of x values:
	y-Unit;dBuV;	Unit of y values:
	Final Meas Time;1.000000;s	Final measurement time
	Margin;6.000000;s	Margin
	Values;8;	Number of test points
	2;154000.000000;81.638535;	Measured values: <Trace>;<x-value>, <y-value>; <phase>; <ground>
	15.638535;N;GND	
	1;158000.000000;86.563789;	
	7.563789;N;GND	
	2;1018000.000000;58.68987	Phase and protective grounding are output only if a line impedance stabilization has been activated. They specify the setting at which the maximum RFI level at the associated frequency was found.
	3;-1.310127;N;GND	
	...	

**Example :**

```
Type;ESPI-3;
Version;1.18;
Date;02.Aug 01;
Mode;Receiver;
Start;150000.000000;Hz
Stop;30000000.000000;Hz
x-Axis;LOG;
Scan Count;1;
Transducer;;
Scan 1:
Start;150000.000000;Hz
Stop;30000000.000000;Hz
Step;4000.000000;Hz
RBW;9000.000000;Hz
Meas Time;0.001000;s
Auto Ranging;OFF;
RF Att;10.000000;dB
Auto Preamp;OFF;
Preamp;0.000000;dB
TRACE 1 FINAL:
Trace Mode;CLR/WRITE;
Final Detector;MAX PEAK;
TRACE 2 FINAL:
Trace Mode;CLR/WRITE;
Final Detector;AVERAGE;
x-Unit;Hz;
y-Unit;dBuV;
Final Meas Time;1.000000;s
Margin;6.000000;dB
Values;11;
2;154000.000000;81.638535;15.638535;N;GND
1;158000.000000;86.563789;7.563789;N;GND
2;1018000.000000;58.689873;-1.310127;N;GND
2;302000.000000;63.177345;-2.822655;L1;GND
2;3294000.000000;56.523022;-3.476978;N;GND
2;1122000.000000;53.849747;-6.150253;N;GND
2;10002000.000000;47.551216;-12.448784;N;GND
1;3390000.000000;59.762917;-13.237083;N;GND
1;9998000.000000;58.309189;-14.690811;L1;GND
2;20002000.000000;45.142456;-14.857544;L1;GND
2;7502000.000000;36.406967;-23.593033;L1;GND
```



FINAL MEAS menu (left side menu)

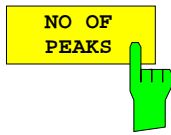

The *NO OF PEAKS* softkey activates the entry field of the number of subranges or peaks for the determination of the peak list. The range of values is 1 to 500.

IEC/IEEE-bus command :CALC:PEAK:SUBR 1 to 500

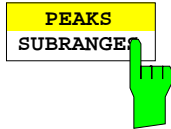

The *PEAKS SUBRANGES* softkey defines the search method with which maxima are searched for within a scan.

**PEAKS** Determination of a specific number of peak values relative to the limit lines with the level values being independent of their frequency spectral distribution.

**SUBRANGES** Generating subrange maxima, i.e. the interference spectrum is further analyzed at frequencies with the highest interference level of a frequency subrange.

IEC/IEEE-bus command :CALC:PEAK:METH SUBR|PEAK

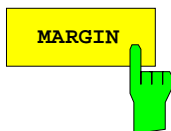

The *MARGIN* softkey activates the entry field of the margin, i.e. of an additional acceptance threshold for the determination of the peak list. The limit line currently used is shifted by this amount for defining the maxima. The range of values is -200 dB to 200 dB.

IEC/IEEE-bus command :CALC:PEAK:MARG -200dB to 200dB



The *FINAL MEAS TIME* softkey activates the entry field of the time of final measurement.

IEC/IEEE-bus command :SWEep:TIME:FME <num\_value>



The *AUTOMATIC FINAL* softkey selects the automatic routine for the final measurement. This routine is run according to the available frequency list without user interaction..

IEC/IEEE-bus command --

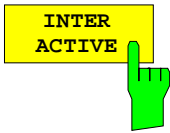

The *INTERACTIVE* softkey selects the following sequence for the final measurement:

- A frequency from the frequency list is set on the receiver together with the associated settings from the corresponding partial scan.
- The marker is set on this frequency in the scan diagram.
- The final measurement sequence switches to the *Interrupted* status.
- The signal can be exactly analyzed by modifying the receiver settings.
- *CONTINUE AT HOLD* starts the actual final measurement, the receiver settings being restored except the frequency.
- The current frequency replaces the original one in the frequency list (drifting interference sources)
- Next frequency of frequency list.....

**Note:** *With the AUTOMATIC FINAL softkey in the CONTINUE FINAL MEAS submenu a switchover can be made to the automatic mode before the measurement is started anew.*

IEC/IEEE-bus command            --

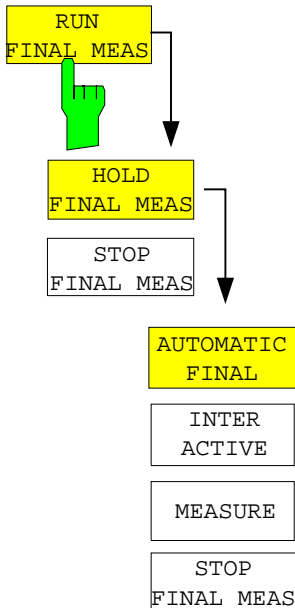

The *RUN FINAL MEAS* softkey starts the final measurement sequence as described above. The *HOLD FINAL MEAS* submenu is called.

The detectors used for the final measurement replace those used in the list or for the prescan.  
 The out-of-limit condition is shown by a plus sign preceding the values in the *DELTA LIMIT* column (see table below).

IEC/IEEE-bus command            --

**Note:** *The final measurement function is only available in the manual mode. For operation under program control it is preferable to read the prescan results and the data-reduced peak list, if any, from the ESPI with the controller and carry out the individual measurements with the controller. This considerably makes the control of the interactive mode easier.*

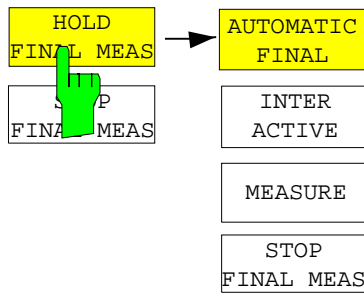

The *HOLD FINAL MEAS* softkey interrupts the automatic run of the final measurement.

The *CONTINUE FINAL MEAS* submenu appears.

With the final measurement halted all receiver settings can be modified for example for examining the signal in detail.

The mode of the measurement (automatic or interactive) can again be selected.

The final measurement can be started with the *MEASURE* softkey.

IEC/IEEE-bus command --

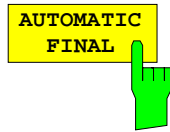

The *AUTOMATIC FINAL* softkey selects the automatic mode for the final measurement (see above).

IEC/IEEE-bus command --

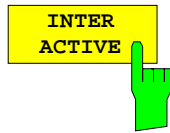

The *INTERACTIVE* softkey selects the interactive mode for the final measurement as described above.

IEC/IEEE-bus command --

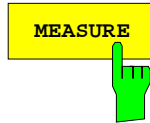

The *MEASURE* softkey continues with the final measurement. The final measurement starts at the next frequency entry on the peak list or at a marked frequency if one or several lines have been skipped with the *SKIP FREQUENCY* softkey.

IEC/IEEE-bus command --



The *STOP FINAL MEAS* softkey halts the final measurement. The final measurement starts from the beginning on a new start. The previously collected data are lost.

IEC/IEEE-bus command --

The peak list available after the final measurement:

The detectors used for the final measurement replace those used in the list or for the prescan.  
 The out-of-limit condition is shown by a plus sign preceding the values in the DELTA LIMIT column.

EDIT PEAK LIST (Final Measurement Results)			
Trace1: 014QP			
Trace2: 014AV			
TRACE3: ---			
TRACE	FREQUENCY	LEVEL dBpT	DELTA LIMIT dB
1 Average	80.0000 MHz	29.99	-9.25
2 Average	89.4800 MHz	35.64	-4.09
1 Quasi Peak	98.5200 MHz	49.94	-0.22
2 Average	98.5200 MHz	48.32	8.15
1 Quasi Peak	100.7200 MHz	55.33	5.07
2 Average	102.3200 MHz	50.86	10.53
1 Quasi Peak	113.2400 MHz	42.50	-8.26
2 Average	116.9200 MHz	44.44	3.53
1 Quasi Peak	125.8800 MHz	54.91	3.68
2 Average	125.8800 MHz	53.86	12.64
1 Quasi Peak	138.4800 MHz	41.83	-9.81
2 Average	138.4800 MHz	39.38	-2.25
2 Average	144.0400 MHz	40.77	-1.04
2 Average	167.0400 MHz	44.82	2.37
2 Average	176.2400 MHz	46.56	3.87
1 Quasi Peak	200.4800 MHz	50.93	-2.31
2 Average	200.4800 MHz	48.27	5.02
1 Quasi Peak	210.2800 MHz	58.71	5.25
2 Average	226.5600 MHz	59.07	15.29
2 Average	230.0000 MHz	46.90	3.05

## Selection of Detectors for Final Measurement

The selection of detectors for the final measurement is made in the right side menu *TRACE DETECTOR* (see section "Selection and setting of traces").

The detectors to be used for the final measurement can be set here for each trace, i.e. any combination of prescan and final measurement is possible. The required flexibility is thus obtained for the diverse test specifications which are covered by means of the ESPI.

The results of prescan and final measurement in a diagram:

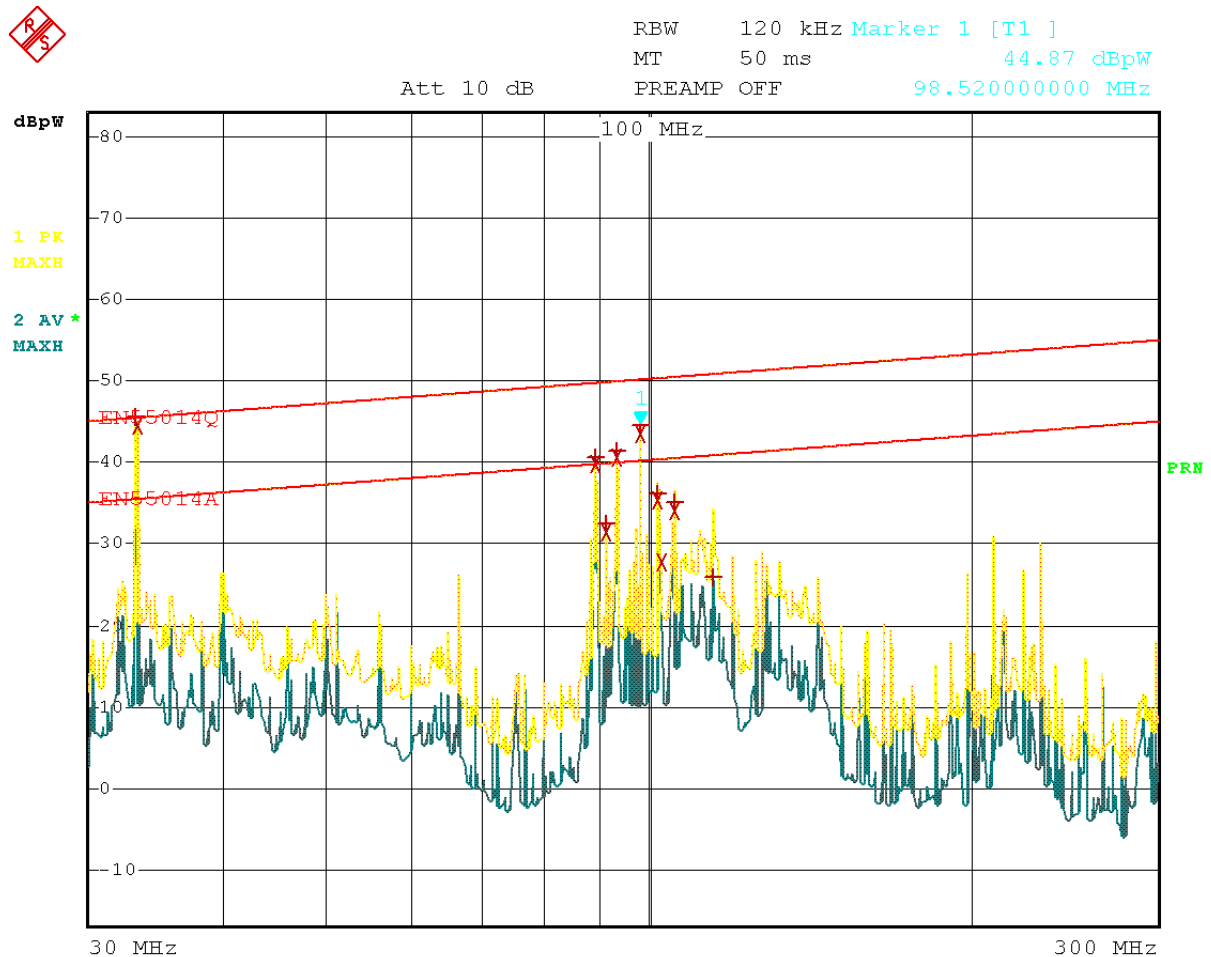

Date: 8.AUG.2001 16:41:37

Fig. 4-2 Results of prescan and final measurement

### Automatic Control of Line Impedance Stabilization Networks

The selected phases are controlled during the prescan and the final measurement via the USERPORT with the LISN switched on.

Only one phase and one PE setting (1 out of n) can be selected for the prescan. Any number of settings can be selected for the final measurement (m out of n).

All selected phase/PE combinations are measured during the final measurement and the maximum value is determined.

FINAL MEAS menu (right side menu)

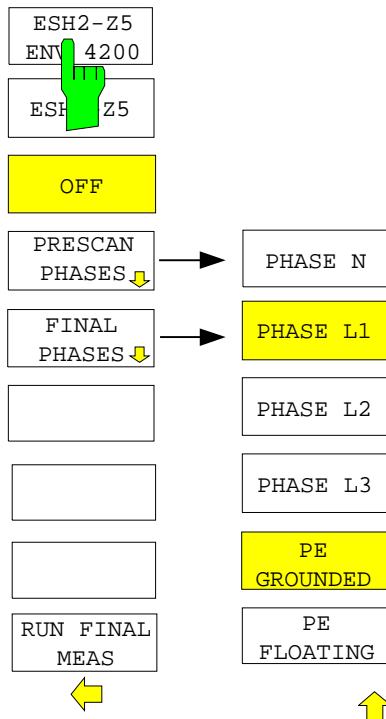

The LISN softkey opens the submenu for automatic control of V-networks (LISNs)

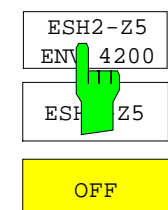

Softkeys *ESH2-Z5/ENV 4200*, *ESH3-Z5* and *OFF* allow to select the V-network to be controlled via the user port.

- ESH2-Z5/ENV 4200*      four-line V-network is controlled,
- ESH3-Z5*                      two-line V-network is controlled,
- OFF*                              remote control is deactivated.

IEC/IEEE-bus command

:INPut:LISN[:TYPE]    TWOPhase | FOURphase | OFF

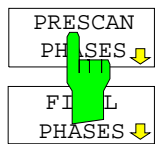

The *PRESCAN PHASES* and *FINAL PHASES* softkeys open the submenu for the selection of phase and protective earth setting.

*PRESCAN PHASES:* Softkeys *ESH2-Z5/ENV 4200*, *ESH3-Z5* and *OFF* or *PHASE N*, *PHASE L1*, *PHASE L2* and *PHASE L3* as well as *PE GROUNDED* and *PE FLOATING* are toggle keys. Only one of them can be activated at a time.

*FINAL PHASES:* All combinations of phases and PE setting are possible.

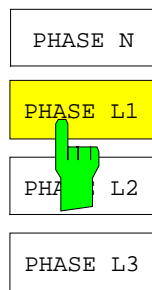

Softkeys *PHASE N*, *PHASE L1*, *PHASE L2* and *PHASE L3* select the phase of the V-network on which the RFI voltage is to be measured.

*PHASE N* RFI on phase N is measured,

*PHASE L1* RFI on phase L1 is measured,

*PHASE L2* RFI on phase L2 is measured (only for *ESH2-Z5/ENV 4200*),

*PHASE L3* RFI on phase L3 is measured (only for *ESH2-Z5/ENV 4200*).

IEC/IEEE-bus command :INP:LISN:PHAS L1 | L2 | L3  
| N

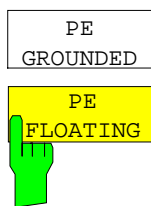

Softkeys *PE GROUNDED* and *PE FLOATING* switch the protective earth conductor chokes on or off.

*PE GROUNDED* protective earth conductor choke switched off,

*PE FLOATING* protective earth conductor choke switched on.

IEC/IEEE-bus command :INP:LISN:PEAR GRO | FLO

Settings made in the *PRESCAN PHASES* menu are immediately output at the user port. This way, the menu can be used to remote control the V-networks during manual measurements.

For automatic phase selection with the V-networks ESH2-Z5 and ESH3-Z5 the ESPI user interface and the V-networks have to be connected via a control line:

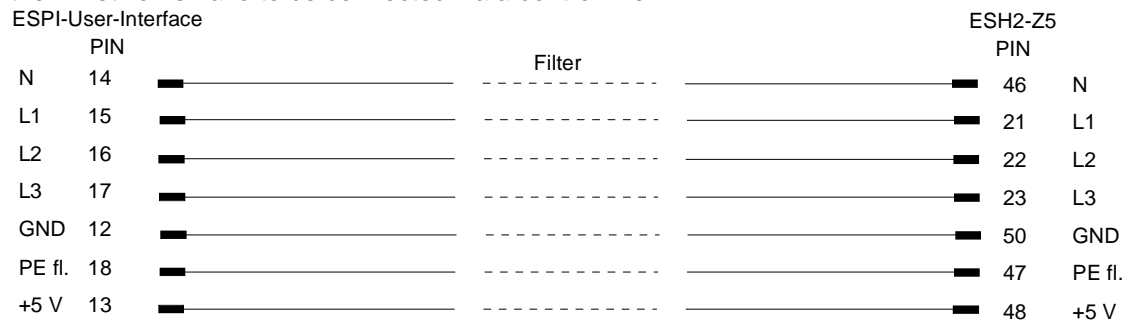

Fig. 4-3 Connection ESPI with ESH2-Z5 (for direct connection without a filter: cable EZ-13)

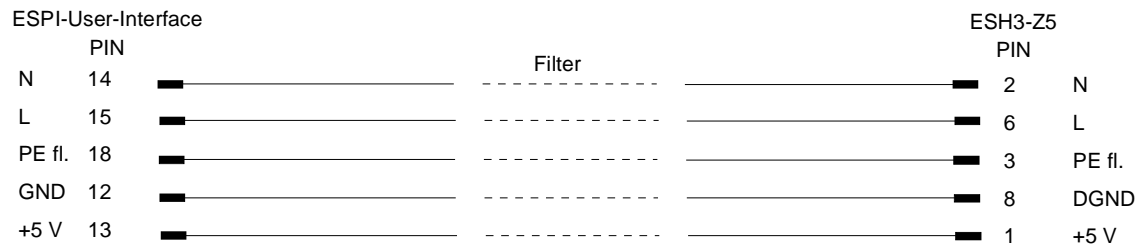

Fig. 4-4 Connection ESPI with ESH2-Z5 (for direct connection without a filter: cable EZ-14, model 02)

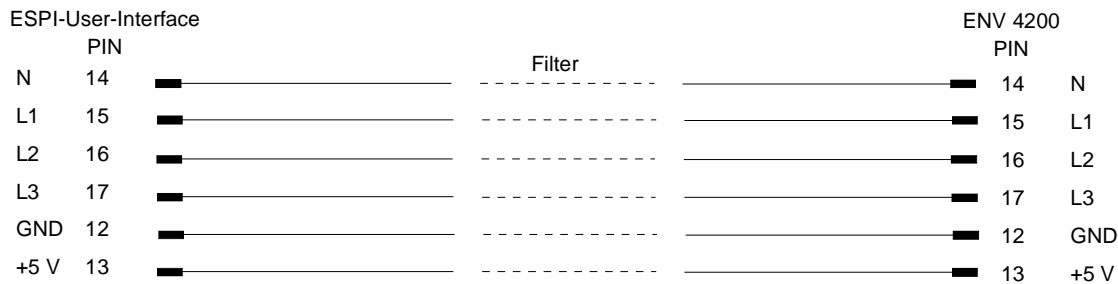

Fig. 4-5 Connection ESPI with ENV4200 (for direct connection without a filter: cable EZ-21)

For controlling the phase selection and the PE simulating network of the V-networks ESH2-Z5, ESH3-Z5 and ENV4200, the +5-V supply voltage and some control lines are to be routed through the wall of the shielded room.

The connection cables EZ-14 and EZ-5 can be provided for the 4-line V-network ESH2-Z5, the connection cable EZ-14 and EZ-6 for the two-line V-network ESH3-Z5 and the connection cables ES-14 and EZ-21 for the 4-line V-network ENV4200.



Suggested configuration of cables EZ-14/EZ-5/EZ-6/EZ-21

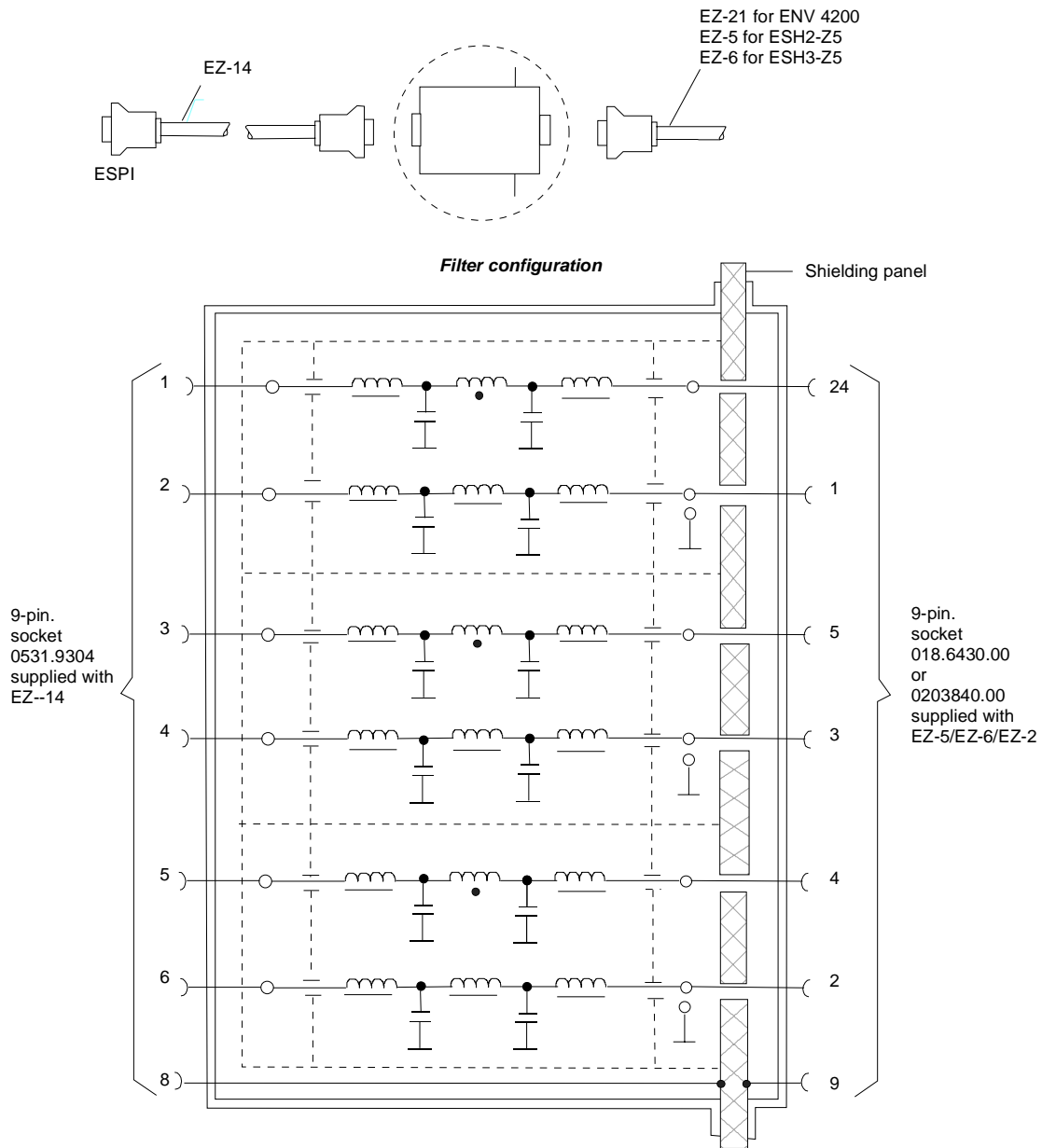

Fig. 4-6 Assignment of connection cables EZ-5, -6, -14 and -21 with AF filters for feeding the 5-V supply and the control information for the V-networks ESH2-Z5, ESH3-Z5 and ENV4200 into a shielded room.

**Note:** When the ESPI is used inside the shielded room, the filter configuration is omitted. The cable EZ-14 is then used for controlling the ESH3-Z5, the cable EZ-13 for controlling the ESH2-Z5, and the cable EZ-21 for controlling the ENV4200.

## Frequency Scan - SWEEP Key

In the scan mode, ESPI measures in a predefined frequency range with selectable step width and measurement time for each frequency.

Either the current receiver settings or the settings defined in the Scan table are used. Up to 10 subranges which need not be next to each other can be defined within one scan. The subranges are then scanned by ESPI one after the other. Measurement ranges should not overlap. The parameters to be measured in each subrange can be selected independently (*SWEEP* menu, *SCAN TABLE* table).

Transducer factors or transducer sets and limit lines can be defined and displayed separately and are not part of the scan data record.

The scanned frequency range is defined by the start and stop frequency set independently of the scan table (*SCAN TABLE* table or *FREQUENCY* menu). A scan table can thus be defined for each measurement task, which can be stored and reloaded. The required frequency range can be defined by means of two parameters which can be set via keys so that no elaborate editing has to be done in the scan table.

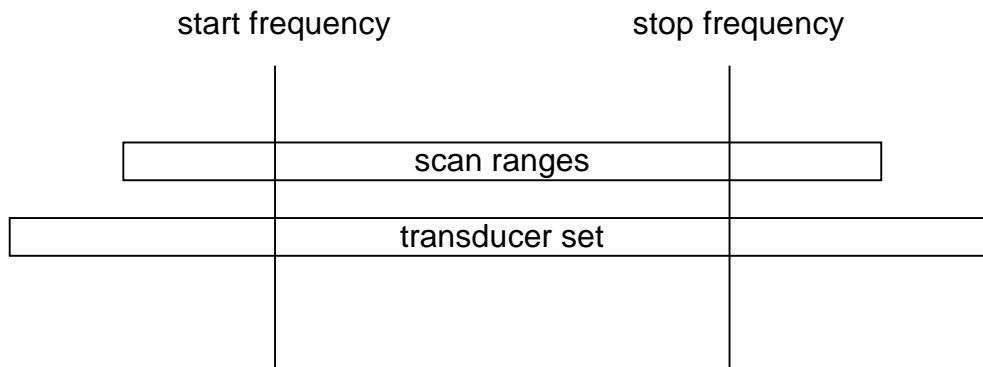

Fig. 4-7 Definition of scan range

Full-screen or split-screen mode can be selected for result display. In the full-screen mode, the result diagram covers the whole screen area.

In split-screen mode, the upper half of the screen displays the frequency and level readout, i.e. a bargraph. The diagram is displayed in the lower half

Up to 3 detectors can be measured simultaneously. They are assigned to traces 1 to 3. Since the detectors are set only once, it is not possible to measure with different detectors in different the subranges.

Scanning is started with the *RUN* softkey. The scan can be performed as a single scan or continuously. In the case of single scan it is stopped when the stop frequency is reached. The continuous scan can be interrupted with the *HOLD SCAN* softkey or terminated with *STOP SCAN*.

The maximal number of measured frequencies is limited to 100.000. A maximum of 3 x 100.000 values (100.000 per detector) can be stored for postprocessing. If the scan subranges are defined so that more than the possible values would be measured, a respective message is output upon the scan start. Afterwards the scan is performed up to the maximum value.

At least one scan is defined in the list. Two subranges are defined in the default setup. All other parameters are shown in the following table:

Table 4-3 Default setup of scan table

	Range 1	Range 2
Start frequency	150 kHz	30 MHz
Stop frequency	30 MHz	1 GHz
Step width	Auto	Auto
IF bandwidth	9 kHz	120 kHz
Measurement time	1 ms	100 $\mu$ s
Auto ranging	OFF	OFF
Attenuation mode	Normal	Normal
RF attenuation	10 dB	10 dB
Preamplification	OFF	OFF

The diagram parameters to be defined are: start frequency 150 kHz, stop frequency 1 GHz, min. level 0 dB $\mu$ V, grid range log 100 dB, log. frequency axis and continuous scan.

The measurement parameters correspond to the settings recommended for overview measurements to CISPR 16.

### Entry of Scan Data

Pressing the *SWEEP* key opens the menu to configure and start the scan.

*SWEEP* menu

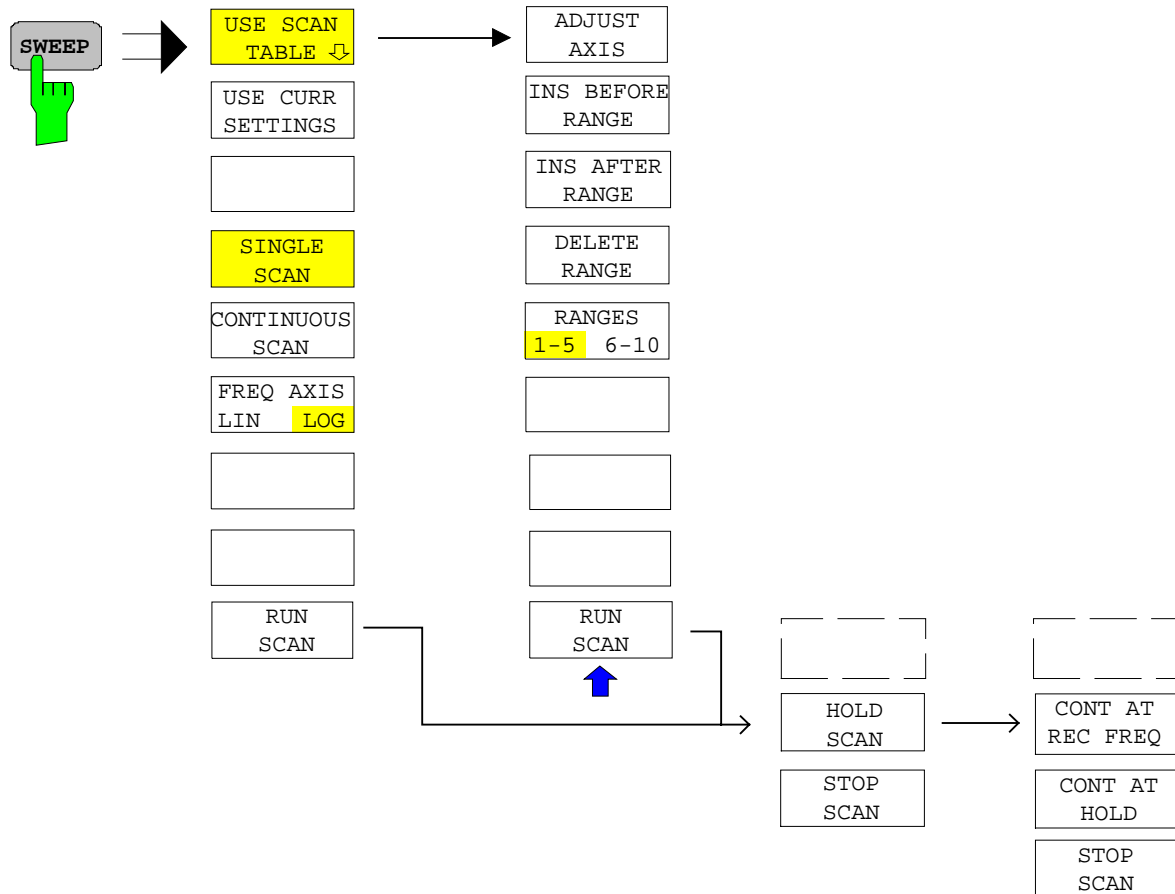

A scan is defined in the form of tables or it is performed using the current setting.

In the *SCAN* table, the scan subranges are defined . Each scan range is specified by start frequency, stop frequency, step width and the measurement parameters that are valid for this range.

The scan can be performed as a single scan or continuously (softkeys *SINGLE SCAN* and *CONTINUOUS SCAN*).

Scanning is started with the *RUN SCAN* softkey. .

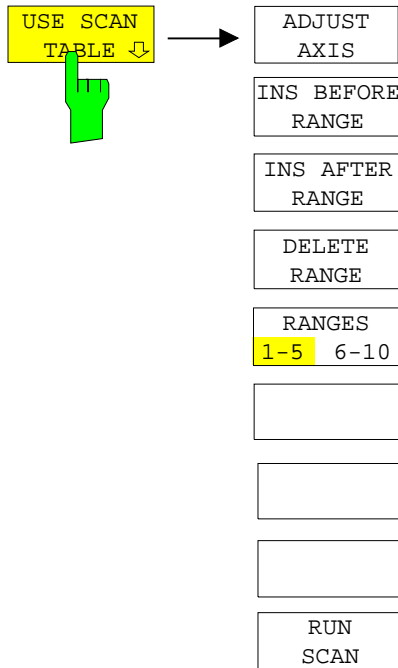

The *DEFINE SCAN* softkey *USE SCAN TABLE* opens a submenu where existing scan tables can be edited or new ones created. Tables with the current scan settings are displayed.

IEC/IEEE-bus command --

In the *SCAN TABLE* the parameters for the individual subranges can be set.

*Scan Start* start frequency of display range  
*Scan Stop* stop frequency of display range  
*Step Mode* step mode ( linear or logarithmic frequency switching)

*Start* start frequency of scan range  
*Stop* stop frequency of scan range  
*Step Size* step size  
*RES BW* resolution bandwidth  
*Meas Time* measurement time  
*Auto Ranging* automatic selection of attenuation  
*RF Attn* RF attenuation  
*Preamp* 20 dB preamplification  
*Auto Preamp* auto range with preamplification

SCAN TABLE					
Scan Start	20.000 MHz				
Scan Stop	1.250 GHz				
Step Mode	LIN				
	RANGE1	RANGE2	RANGE3	RANGE4	RANGE5
Start	150.000 kHz	30.000 MHz	1.000 GHz		
Stop	30.000 MHz	1.000 GHz	2.000 GHz		
Step Size	4 kHz	40 kHz	400 kHz		
Res BW	9 kHz	120 kHz	1 MHz		
Meas Time	1 ms	100 us	100 us		
Auto Ranging	OFF	OFF	OFF		
RF Attn	10 dB	10 dB	10 dB		
Preamp	OFF	OFF	OFF		
Auto Preamp	OFF	OFF	OFF		

**Scan Start - start frequency of display range**

Range is  $f_{min}$  to  $f_{max} - 10$  Hz

This value can also be set in the *FREQ* menu (*START* softkey).

IEC/IEEE-bus command `FREQ:STAR 20 MHz`

**Scan Stop - stop frequency of display range**

Range is  $f_{min}$  to  $f_{max}$ .

his value can also be set in the *FREQ* menu (*STOP* softkey).

IEC/IEEE-bus command `FREQ:STOP 1250 MHz`

**Step Mode - selection of frequency switching mode**

Linear or logarithmic frequency switching can be selected. The selected setting is valid for all scan ranges.

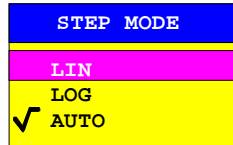

LIN linear frequency switching.

AUTO linear frequency switching.  
The step width is selected automatically depending on the set resolution bandwidth so that all signals occurring in the scan range are reliably detected without any significant measurement error (about one third of resolution bandwidth)

LOG logarithmic frequency switching.  
The frequency is incremented in % of the current frequency..

IEC/IEEE-bus command `SWE:SPAC LIN`

**Start - Entry of start frequency**

The start frequency of a subrange must be equal to or greater than the stop frequency of the previous subrange.

On entering the start frequency, the preceding scan range is – if necessary – adapted automatically to avoid overlapping of scan ranges.

IEC/IEEE-bus command `SCAN1:STAR 150 kHz`

**Stop - Entry of stop frequency**

The stop frequency of a subrange must be equal to or greater than the start frequency of the subrange.

On entering the stop frequency, the preceding scan range is – if necessary – adapted automatically to avoid overlapping of scan ranges.

IEC/IEEE-bus command `SCAN1:STOP 30 MHz`

**Step Size - Entry of step size**

In the case of linear frequency increments, step widths between 1 Hz and the maximum ESPI frequency can be set. When a step size greater than the scan range is entered (from start to stop), ESPI performs a measurement at the start and stop frequency.

With logarithmic frequency increments, values between 0.1% and 100% can be set with steps of 1/2/3/5.

With *STEP AUTO* selected, the step size cannot be changed because it is automatically set with respect to the IF bandwidth.

IEC/IEEE-bus command `SCAN1:STEP 4 kHz`

**RES BW - Entry of IF bandwidth**

In the case of quasi-peak weighting, usually a fixed bandwidth is set which cannot be changed (CISPR).

However, the coupling of the IF bandwidth to the frequency range can be cancelled using softkey *QP RBW UNCOUPLED* in the *MEAS DETECTOR* menu.

IEC/IEEE-bus command `SCAN1:BAND:RES 9 kHz`

**Meas Time - Entry of measurement time**

The measurement time can be set between 100  $\mu$ s and 100 s separately for each subrange. In the case of quasi-peak weighting, the minimum is 1 ms. The measurement time can be set independently for each scan range.

IEC/IEEE-bus command `SCAN1:TIME 1ms`

**Auto Ranging - Activates the autorange function**

ON ESPI automatically sets the input attenuation as a function of the signal level.

**Caution:**

*If 0 dB RF attenuation is used with autoranging, care must be taken that the permissible signal level at the RF input is not exceeded.*

*Exceeding this level would damage the input mixer.*

*The 0 dB attenuation should under no circumstances be used when RFI voltage measurements are performed with the aid of artificial networks as in this case very high pulses occur during phase switching.*

OFF The input attenuation setting of the scan table is used.

IEC/IEEE-bus command `SCAN1:INP:ATT:AUTO OFF`

**RF Atten - Entry of a fixed RF attenuation**

The RF attenuation can be set separately for each subrange

IEC/IEEE-bus command `SCAN1:INP:ATT:AUTO OFF`

**Preamp - Switching the preamplifier on and off**

The preamplifier can be switched on/off separately for each subrange

IEC/IEEE-bus command `SCAN1:INP:GAIN:STAT OFF`

**Auto Preamp - Activates the auto preamp function**

ON The preamplifier is considered in autoranging. It is only cut in after the attenuation has been reduced to the minimum settable value.

ON Auto ranging without preamplification

IEC/IEEE-bus command `SCAN1:INP:GAIN:AUTO OFF`

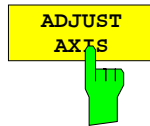

The *ADJUST AXIS* softkey automatically sets the limits of the diagram so that the lower limit frequency corresponds to the start frequency of range 1 and the upper limit frequency to the stop frequency of the last range.

IEC/IEEE-bus command --

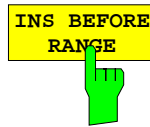

The *INS BEFORE RANGE* softkey shifts the active scan range in the table to the left by one column. A new column with identical settings is created. The limit frequencies can be changed accordingly.

IEC/IEEE-bus command --



The *INS AFTER RANGE* softkey shifts the active scan range in the table to the right by one column. A new column with identical settings is created. The limit frequencies can be changed accordingly.

IEC/IEEE-bus command --



The *DELETE RANGE* softkey clears the activated scan range. All other ranges are shifted to the left by one column.

IEC/IEEE-bus command --

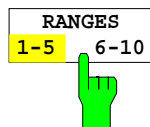

With the *RANGES 1-5/6-10* softkey a switchover can be made between ranges 1-5 and 6-10.

IEC/IEEE-bus command --



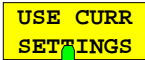

The *USE CURR SETTINGS* softkey activates a scan which is performed using the current receiver settings. The step size is automatically set with respect to the IF bandwidth (Step Mode Auto). The start and stop frequency is set via the *FREQ* menu.

IEC/IEEE-bus command --



Pressing the *SINGLE SCAN* softkey triggers a frequency scan. ESPI stops at the end frequency.

The enhancement label *SGL* displayed at the screen edge indicates that the single-scan mode is set.

IEC/IEEE-bus command :INIT2:CONT OFF



The *CONTINUOUS SCAN* softkey selects the continuous scan mode. ESPI scans continuously until the scan is stopped.

IEC/IEEE-bus command :INIT2:CONT ON





The *FREQ AXIS LIN/LOG* switches between linear and logarithmic frequency axis.

Default is LOG.

IEC/IEEE-bus command DISP:TRAC:X:SPAC LOG

## Running a Scan

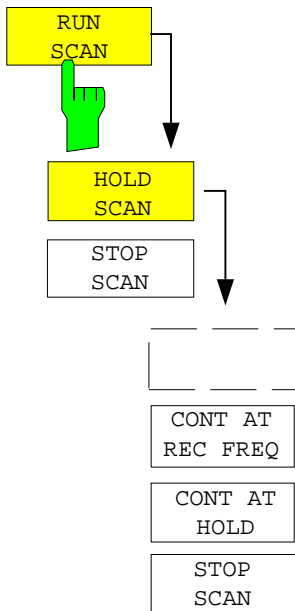
CONFIGURATION MODE - RECEIVER menu



The *RUN SCAN* softkey starts the frequency scan with the selected settings. The *HOLD SCAN* submenu is displayed instead of the menu shown before the scan is started.

At the beginning of the scan, ESPI sets up the diagram as specified in the scan table and starts the scan in the selected mode (*SINGLE* or *CONTINUOUS*). With *SINGLE* selected, ESPI performs a single scan and stops at the end frequency. With *CONTINUOUS* selected, the scan is performed continuously until it is deliberately stopped.

The measurement can be interrupted with *HOLD SCAN* or stopped with *STOP SCAN*. The two softkeys are displayed instead of the menu shown before the scan is started.

If a transducer set is defined with points of changeover, the scan automatically stops at the frequencies of the new subrange of the transducer set and the user may exchange the transducer.

The following message informs the user that the limit has been reached:

*TDS Range # reached, CONTINUE / BREAK*

He can continue the scan at the point of change over by confirming the message (*CONTINUE*) or he can switch off the transducer (*BREAK*).

IEC/IEEE-bus command      `INITiate2`

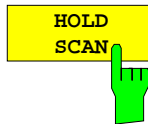

The *HOLD SCAN* softkey interrupts the scan.

The scan stops at the frequency at which it was interrupted until it is continued with the *CONT AT REC FREQ* or *CONTINUE AT HOLD* softkeys.

While the scan is stopped, the receiver settings can be changed, e.g. for a detailed analysis of the recorded trace.

IEC/IEEE-bus command      `:HOLD`

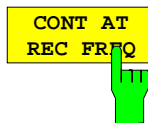

With the *CONT AT REC FREQ* softkey the scan is continued at the current receiver frequency when the receiver frequency is lower than the frequency at which the scan was interrupted.

Otherwise the scan continues at the frequency at which it was interrupted.

The scan is always continued with the settings in the scan table.

IEC/IEEE-bus command      `:INITiate2:CONMeasure`

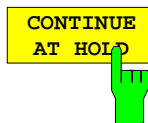

With the *CONT AT HOLD* softkey the scan is continued where it was interrupted. The scan is always continued with the settings in the scan table.

IEC/IEEE-bus command      `--`

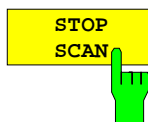

The *STOP SCAN* softkey stops the scan. Upon restart, scanning starts at the beginning. The results of the performed measurements are lost.

IEC/IEEE-bus command      `:ABORt`

## Triggering the Scan– TRIG Key

The *TRIG* key opens a menu for selection of the trigger sources and the trigger polarity. The active trigger mode is indicated by highlighting the corresponding softkey.

To indicate that a trigger mode other than *FREE RUN* has been set, the enhancement label **TRG** is displayed on the screen. If two windows are displayed, TRG appears next to the appropriate window.

TRIGGER menu

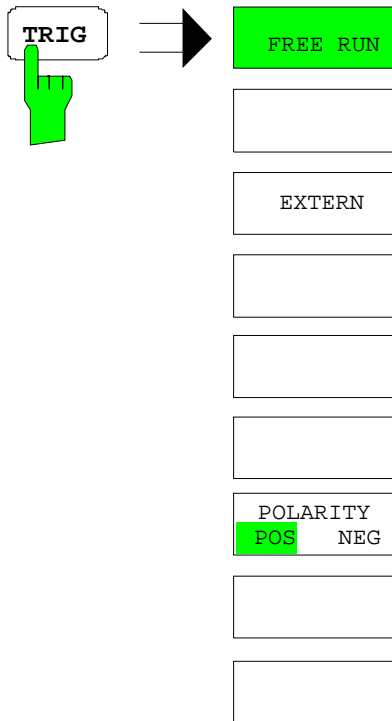

The *FREE RUN* softkey activates the free-run sweep mode, i.e. start of a scan is not triggered. Once a measurement is completed, another is started immediately.

*FREE RUN* is the default setting of ESPI.

IEC/IEEE-bus command: TRIG:SOUR IMM

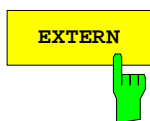

The *EXTERN* softkey activates triggering via a TTL signal at the input connector *EXT TRIGGER/GATE* on the rear panel.

IEC/IEEE-bus command: TRIG:SOUR EXT  
SWE:EGAT:SOUR EXT



The *POLARITY POS/NEG* softkey selects the polarity of the trigger source.

The scan starts after a positive or negative edge of the trigger signal. The selected setting is highlighted.

The selection is valid for all trigger modes with the exception of *FREE RUN*.

The default setting is *POLARITY POS*.

IEC/IEEE-bus command: TRIG:SLOP POS

## Marker Functions – MKR Key

MKR menu:

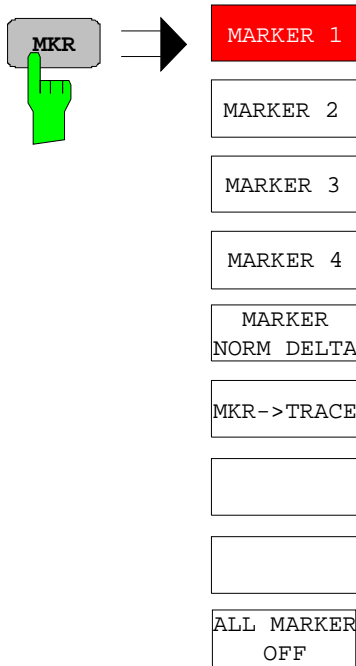

The *MARKER 1/2/3/4* .softkey selects the corresponding marker and activates it.

*MARKER 1* is always the normal marker. After they have been switched on, *MARKERS 2 to 4* are delta markers that refer to *MARKER 1*. These markers can be converted into markers with absolute value display by means of the *MARKER NORM DELTA* softkey. When *MARKER 1* is the active marker, pressing the *MARKER NORM DELTA* softkey switches on an additional delta marker.

Pressing the *MARKER 1 to 4* softkey again switches off the selected marker.

IEC/IEEE bus commands           :CALC:MARK ON;  
   :CALC:MARK:X 10.7MHz;  
   :CALC:MARK:Y?

When several traces are being displayed, the marker is set to the maximum value (peak) of the active trace which has the lowest number (1 to 3). In case a marker is already located there, it will be set to the frequency of the next lowest level (next peak).

A marker can only be enabled when at least one trace in the corresponding window is visible.

If a trace is turned off, the corresponding markers and marker functions are also deactivated. If the trace is switched on again (*VIEW, CLR/WRITE;..*), the markers along with coupled functions will be restored to their original positions provided the markers have not been used on another trace.

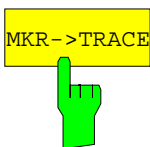

The *MKR→TRACE* softkey places the marker on a new trace. The trace is selected via a data entry field. Only those traces can be selected which are visible on the screen in the same window.

**Example:**

Three traces are presented on the screen. The marker is always on Trace 1 on switching on.

[MKR ->TRACE]  
 "2"<ENTER>           The marker jumps to Trace 2 but remains on the previous frequency or time.

[MKR ->TRACE]  
 "3"<ENTER>           The marker jumps to Trace 3. '

IEC/IEEE-bus command:   CALC:MARK1:TRAC 1  
                                   CALC:DELT:TRAC 1

## Change of Settings via Markers – MKR ⇒ Key

The MKR → menu offers functions through which instrument parameters can be changed with the aid of the currently active marker. The functions can be used on markers and delta markers.

On opening the menu, the entry for the last active marker is activated; if no marker was enabled, MARKER 1 is activated and a peak search is performed.

MKR → menu

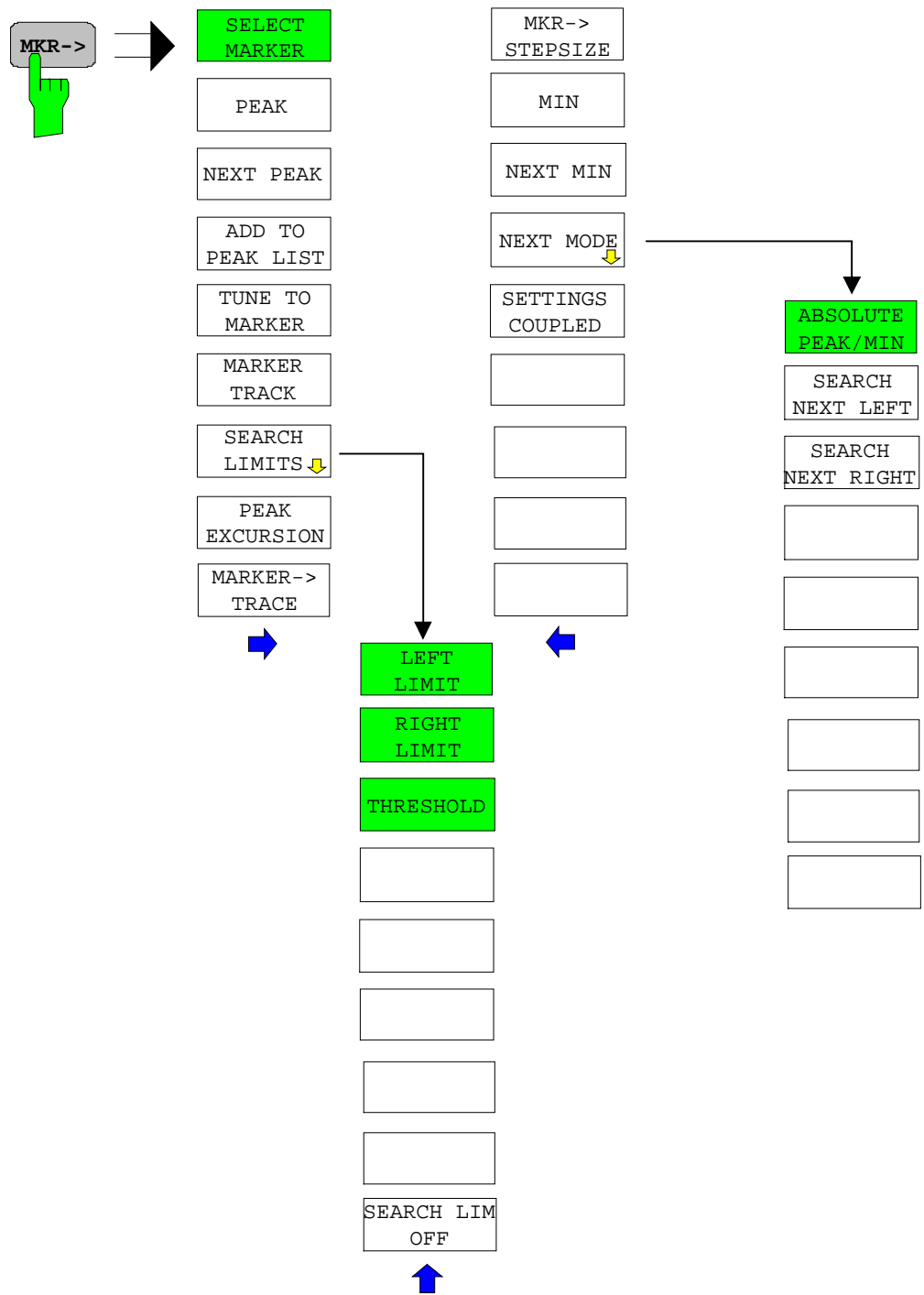



The *SELECT MARKER* softkey activates the numerical selection of the marker in the data entry field. If no marker is active when **MKR->** menu is called, *MARKER 1* is automatically switched on. Delta marker 1 is selected by input of '0'.

IEC/IEEE-bus command:    CALC:MARK1 ON;  
                               CALC:MARK1:X <value>;  
                               CALC:MARK1:Y?

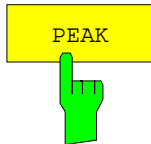

The *PEAK* softkey sets the active marker or delta marker to the peak of the trace.

If no marker is active when **MKR->** menu is called, *MARKER 1* is automatically switched on and the peak search is performed.

IEC/IEEE-bus command:        CALC:MARK:MAX  
                                   CALC:DELT:MAX



The *NEXT PEAK* softkey sets the active marker/delta marker to the next lower peak value on the trace. The search direction is defined in the *NEXT MODE* submenu (see analyzer mode).

IEC/IEEE-bus command:        CALC:MARK:MAX:NEXT  
                                   CALC:DELT:MAX:NEXT



The *ADD TO PEAK LIST* softkey adds the receiver frequency of the current marker to the peak list (see also Section "Data Reduction and Peak List").

IEC/IEEE bus command        --



The *TUNE TO MARKER* softkey sets the receiver frequency to the marker frequency.

IEC/IEEE bus command    :CALC:MARK:FUNC:CENT



The *MARKER TRACK* softkey couples the current receive frequency to the marker frequency.

IEC/IEEE bus command    :CALC:MARK:COUP ON

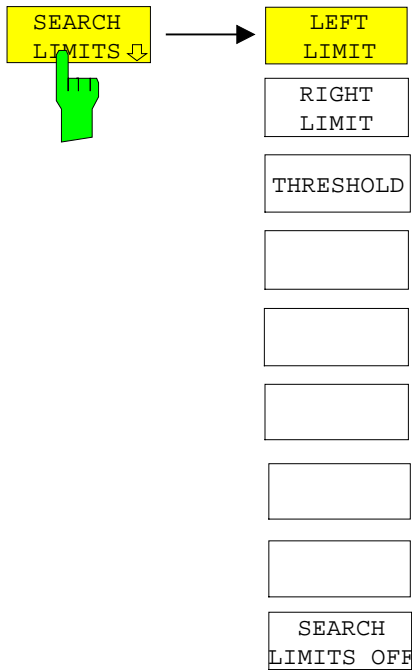

The *SEARCH LIMITS* softkey limits the search range for maximum or minimum search. The softkey switches to a submenu in which the search range limits can be set in the x and y direction.

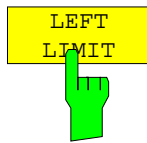

The *LEFT LIMIT* and *RIGHT LIMIT* softkeys define the two vertical lines SL1 and SL2. The search is performed between these lines in the frequency and time domain. If only one line is enabled, line SL1 is the lower limit and the upper limit corresponds to the stop frequency. If SL2 is also enabled, it determines the upper limit.

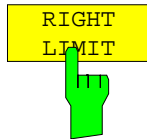

IEC/IEEE-bus command: `CALC:MARK:X:SLIM:LEFT 1MHZ`  
`CALC:MARK:X:SLIM:RIGH 10MHZ`  
`CALC:MARK:X:SLIM ON`

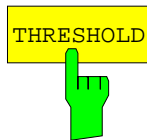

The *THRESHOLD* softkey defines the threshold line. The threshold line represents a limit for the level range of the max. search at the lower end and that of the min. search at the upper end.

IEC/IEEE-bus command: `CALC:THR -20dBm`  
`CALC:THR ON`



The *SEARCH LIMIT OFF* softkey disables all limits of the search range.

IEC/IEEE-bus command: `CALC:MARK:X:SLIM OFF`  
`CALC:THR OFF`



The *PEAK EXCURSION* softkey activates an entry box for selecting the minimum amount by which a signal level must decrease/increase before it is recognized by the *NEXT PEAK* and *NEXT MIN* search functions as a maximum or minimum.

Input values from 0 to 80 dB are allowed, the resolution being 0.1 dB.

IEC/IEEE-bus command: `CALC:MARK:PEXC 10dB`

For detailed explanation see softkey *PEAK EXCURSION* in *ANALYZER* mode

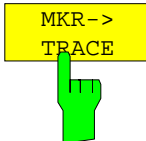

The *MKR->TRACE* softkey sets the active marker to a new trace. Please note that only a trace visible in the measurement window can be selected.

This softkey is also available in the *MKR* menu.

IEC/IEEE-bus command: `CALC:MARK:TRAC 2`

#### Example:

Three traces are displayed on the screen. The marker is always on Trace 1 after switching on.

`[MKR ->TRACE ] "2" <ENTER>` The marker jumps to Trace 2 but remains at the previous frequency or time.

`[MKR ->TRACE] "3" <ENTER>` The marker jumps to Trace 3.

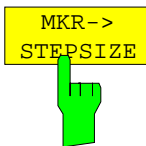

The *MKR->CF STEPSIZE* softkey sets the step size for the receiver frequency variation to the current marker frequency, and also sets step size adaptation to *MANUAL*. *STEPSIZE* remains at this value until the receiver frequency entry mode in the *STEP* menu is switched from *MANUAL* to *AUTO* again.

The *MKR->CF STEPSIZE* function is, above all, useful in the measurement of harmonics.

IEC/IEEE-bus command: `CALC:MARK:FUNC:CST`

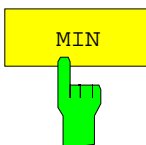

The *MIN* softkey sets the active marker to the minimum value on the corresponding trace.

IEC/IEEE-bus command: `CALC:MARK:MIN`  
`CALC:DELT:MIN`

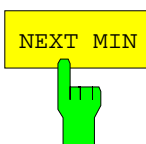

The *NEXT MIN* softkey sets the active marker to the next higher minimum value on the corresponding trace. The search direction is defined in the *NEXT MODE* submenu (see below).

IEC/IEEE-bus command: `CALC:MARK:MIN:NEXT`  
`CALC:DELT:MIN:NEXT`



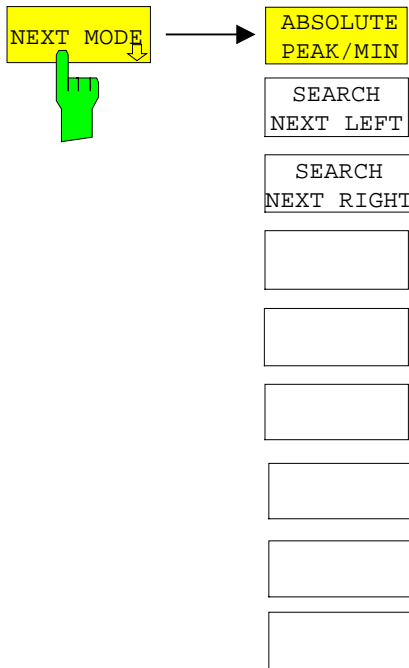

The *NEXT MODE* softkey opens a sub menu for definition of the search direction for *NEXT PEAK* and *NEXT MIN*.

The softkeys are selection switches, i.e. only one of them can be active at any one time.



The *ABSOLUTE PEAK/MIN* softkey defines that the next higher maximum or minimum is searched for on the whole trace.

IEC/IEEE bus commands: `CALC:MARK:MAX:NEXT`  
`CALC:DELT:MAX:NEXT`  
`CALC:MARK:MIN:NEXT`  
`CALC:DELT:MIN:NEXT`



The *SEARCH NEXT LEFT* softkey defines that the next higher maximum or minimum on the left of the active marker is searched for, i.e. only frequencies or time values smaller than the current marker frequency or time are taken into account.

IEC/IEEE bus commands: `CALC:MARK:MAX:LEFT`  
`CALC:DELT:MAX:LEFT`  
`CALC:MARK:MIN:LEFT`  
`CALC:DELT:MIN:LEFT`



The *SEARCH NEXT RIGHT* softkey defines that the next higher maximum or minimum on the right of the active marker is searched for, i.e. only frequencies or time values higher than the current marker frequency or time are taken into account.

IEC/IEEE bus commands: `CALC:MARK:MAX:RIGH`  
`CALC:DELT:MAX:RIGH`  
`CALC:MARK:MIN:RIGH`  
`CALC:DELT:MIN:RIGH`

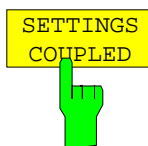

The *SETTINGS COUPLED* softkey couples the receiver frequency settings from the corresponding subscans to the marker frequency for functions *TUNE TO MARKER* and *MARKER TRACK*.

IEC/IEEE bus command : `CALC:MARK:SCO ON`

## Marker Functions – MKR FCTN Key

MKR FCTN Menu:

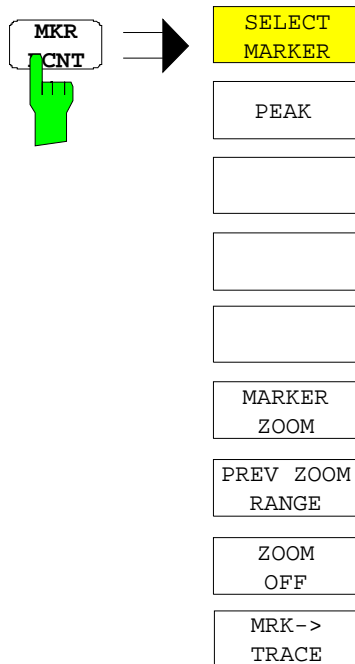

On calling the menu, the entry for the last active marker is activated (*SELECT MARKER* softkey); if no marker is activated, marker 1 is activated and a maximum search (*PEAK* softkey) is performed. The marker can be set to the desired trace by means of *MKR -> TRACE* softkey.



The *MARKER ZOOM* softkey zooms 10% of the diagram around the current marker. It opens at the same time a data entry field which allows to enter any frequency range which is then displayed. Pressing the softkey again expands the diagram such that only 3 measured values are represented.

IEC/IEEE bus command :CALC:MARK:FUNC:ZOOM <num\_value>

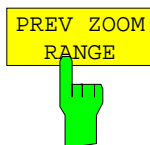

The *PREVIOUS ZOOM* softkey sets again the previous frequency range

IEC/IEEE bus command --

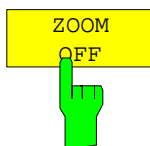

The *ZOOM OFF* softkey switches off the zoomed representation.

IEC/IEEE bus command :DISP:TRAC:X:ZOOM OFF

## Selection and Setting of Traces –TRACE Key

The ESPI is capable of displaying up to three different traces at a time in a diagram. A trace consists of a maximum of 501 pixels on the horizontal axis (frequency or time). If more measured values than pixels are available, several measured values are combined in one pixel.

The traces are selected using the *SELECT TRACE* softkey in the menu of the *TRACE* key.

The traces can individually be activated for a measurement or frozen after completion of a measurement. Traces that are not activated are blanked.

The display mode can be selected for each trace. Traces can be overwritten in each measurement (CLEAR/WRITE mode), averaged over several measurements (AVERAGE mode), or a maximum or minimum value can be determined from several measurements and displayed (MAX HOLD or MIN HOLD).

Individual detectors can be selected for the various traces. The max peak detector and min peak detector display the maximum and minimum value of the level within a pixel. The rms detector displays the power (rms value) of the measured values within a pixel, the average detector the average value.

The quasi-peak detector yields the level weighted to CISPR 16.

### Selection of Trace Function

The trace functions are subdivided as follows:

- Display mode of trace (CLEAR/WRITE, VIEW and BLANK)
- Evaluation of the trace as a whole (AVERAGE, MAX HOLD and MIN HOLD)
- Evaluation of individual pixels of a trace (MAX PEAK, MIN PEAK, QUASIPeAK, AVERAGE and RMS).

TRACE menu

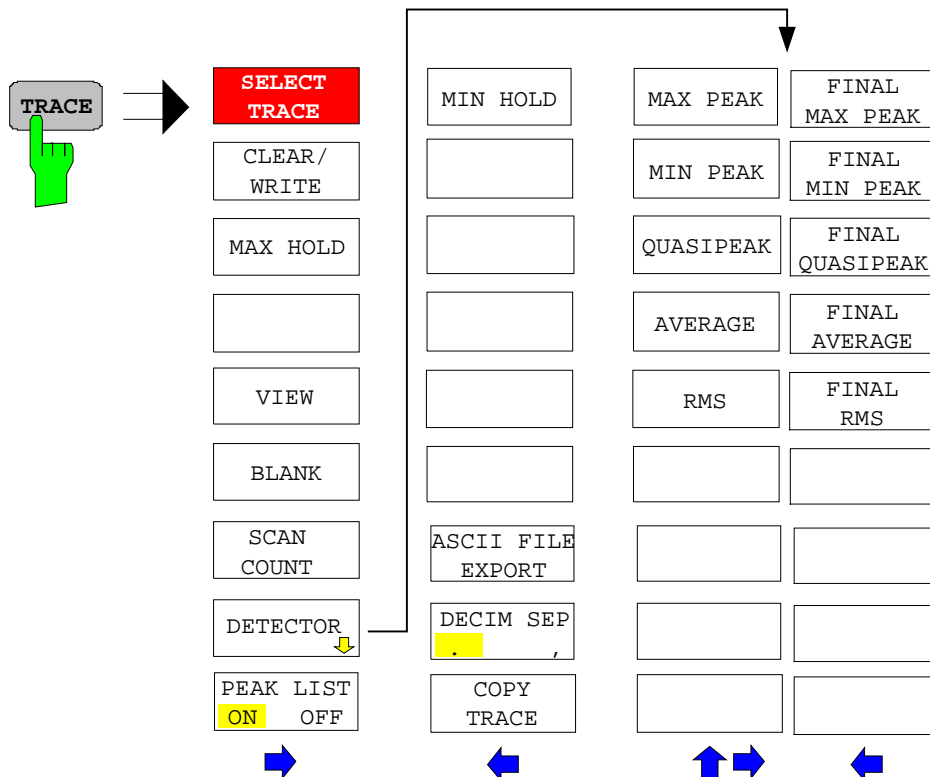

The *TRACE* key opens a menu offering the setting options for the selected trace.

In this menu, the mode of representing the measured data in the frequency or time domain in the 501 pixels of the display is determined. Upon start of the measurement, each trace can be displayed either completely new or based on the previous results.

Traces can be displayed, blanked and copied.

The measurement detector for the individual display modes can be selected directly by the user.

The default setting is trace 1 in the overwrite mode (*CLEAR / WRITE*) and detector *MAX PEAK* is selected, trace 2 is also in the overwrite mode (*CLEAR / WRITE*) and detector *AVERAGE* is selected, trace 3 is switched off (*BLANK*).

The *CLEAR/WRITE*, *MAX HOLD*, *MIN HOLD*, *AVERAGE*, *VIEW* and *BLANK* softkeys are mutually exclusive selection keys.



The *SELECT TRACE* softkey activates the entry for the active trace (1, 2, 3).

IEC/IEEE-bus command -- (selected via numeric suffix of :TRACe)



The *CLEAR/WRITE* softkey activates the overwrite mode for the collected measured values, i.e. the trace is overwritten by each sweep.

Each time the *CLEAR/WRITE* softkey is actuated, ESPI clears the selected trace memory and starts the measurement anew.

IEC/IEEE-bus command            DISP:WIND:TRAC:MODE WRIT

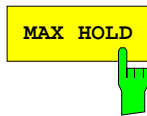

The *MAX HOLD* softkey activates the max peak detector.

ESPI saves the sweep result in the trace memory only if the new value is greater than the previous one.

This is especially useful with modulated or impulsive signals. The signal spectrum is filled up upon each scan until all signal components are detected in a kind of envelope.

Pressing the *MAX HOLD* softkey again clears the trace memory and restarts the max hold mode.

IEC/IEEE-bus command            DISP:WIND:TRAC:MODE MAXH

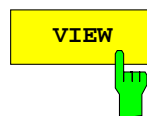

The *VIEW* softkey freezes the current contents of the trace memory and displays it.

If in the *VIEW* display mode the level display range (*GRID RANGE*) or the reference level (*GRID MIN LEVEL*) are changed, ESPI automatically adapts the measured data to the changed display range. This allows an amplitude zoom to be made after the measurement in order to show details of the trace.

IEC/IEEE-bus command            DISP:WIND:TRAC:MODE VIEW

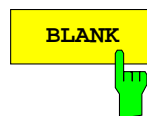

The *BLANK* softkey activates the blanking of the trace on the screen.

IEC/IEEE-bus command            DISP:WIND:TRAC OFF

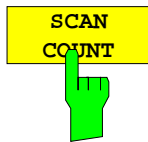

The *SCAN COUNT* softkey activates the entry of the number of scan used in the *SINGLE SCAN* mode.

The allowed range of values is 0 to 30000. The default setting is 1.

IEC/IEEE-bus command            SWE:COUN 10



The *DETECTOR* softkey opens a submenu to select the detector.

The detector type may be indecently selected for each trace.

For description of detector types see Section "Detector Selection" in Analyzer Mode.

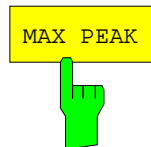

The *MAX PEAK* softkey activates the max peak detector.

IEC\IEEE bus command            DET POS

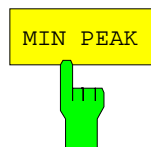

The *MIN PEAK* softkey activates the min peak detector.

IEC\IEEE bus command            DET NEG

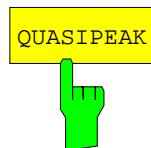

The *QUASIPeAK* softkey selects the quasi-peak detector. The IF bandwidth is adapted as a function of the frequency range. The coupling of the IF bandwidth to the frequency range can be cancelled using softkey *QP RBW UNCOUPLED*.

IEC/IEEE-bus command            DET QPE

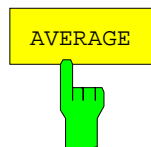

The *AVERAGE* softkey activates the average detector.

IEC\IEEE bus command            DET AVER

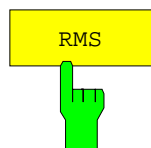

The *RMS* softkey activates the rms detector.

IEC\IEEE bus command            :DET RMS



The *FINAL MAX PEAK* selects the max peak detector for the final measurement.

IEC\IEEE bus command            :DET:FME POS

FINAL  
MIN PEAK



The *FINAL MIN PEAK* selects the min peak detector for the final measurement.

IEC\IEEE bus command :DET:FME NEG

FINAL  
QUASIPeAK



The *FINAL QUASIPeAK* selects the quasi peak detector for the final measurement.

IEC\IEEE bus command :DET:FME QPE

FINAL  
AVERAGE



The *FINAL AVERAGE* selects the average detector for the final measurement.

IEC\IEEE bus command :DET:FME AVER

FINAL  
RMS



The *FINAL RMS* selects the rms detector for the final measurement.

IEC\IEEE bus command :DET:FME RMS

PEAK LIST  
ON OFF



The *PEAK LIST ON / OFF* softkey switches on and off the indication of the peak list or of the final measurement results. The single value is indicated as + or x. The assignment of symbol to trace is fixed.

*RUN SCAN* automatically switches *PEAK LIST* to *OFF* in order to prevent the indication of preceding final measurement results. *PEAK SEARCH* automatically sets *PEAK LIST* to *ON* (see Data Reduction and Peak List)

IEC\IEEE bus command DISP:TRAC:SYMB CROS | OFF

TRACE side menu:

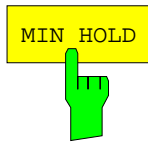

The *MIN HOLD softkey* activates the min peak detector. ESPI saves for each scan the smallest of the previously stored/currently measured values in the trace memory.

This function is useful e.g. for making an unmodulated carrier in a composite signal visible. Noise, interference signals or modulated signals are suppressed by the min hold function whereas a CW signal is recognized by its constant level.

Pressing the *MIN HOLD* softkey again clears the trace memory and restarts the min hold function.

IEC/IEEE-bus command            `DISP:WIND:TRAC:MODE MINH`



The *ASCII FILE EXPORT* softkey stores the active trace in ASCII format on a floppy disk.

IEC/IEEE command    `FORM ASC;`  
                          `MMEM:STOR:TRAC 1, 'TRACE.DAT'`

The file consists of the header containing important scaling parameters, several data sections containing the scan settings and a data section containing the trace data.

The data of the file header consist of three columns, each separated by a semicolon:  
 parameter name; numeric value; basic unit

The data section for the scan ranges starts with the keyword "Scan <n>:", (<n> = number of scan range), followed by the scan data in one or several columns which are also separated by a semicolon.

The data section for the trace data starts with the keyword " Trace <n> " (<n> = number of stored trace), followed by the measured data in one or several columns which are also separated by a semicolon.

This format can be read in from spreadsheet calculation programs, e.g. MS-Excel. It is necessary to define ';' as a separator.

**Note:** *Different language versions of evaluation programs may require a different handling of the decimal point. It is therefore possible to select between separators '.' (decimal point) and ',' (comma) using softkey DECIM SEP.*

Example:

	File contents	Description
<b>File header</b>	Type;ESPI3; Version;1.00; Date;10.Nov 00; Mode;Receiver; Start;150000.000000;Hz Stop;1000000000.000000;Hz x-Axis;LOG;  Detector;AVERAGE; Scan Count;1; Transducer;;	Instrument model Firmware version Date of data set storage Instrument mode Start/stop of the display range. Unit: Hz Scaling of x-axis linear (LIN) or logarithmic (LOG) Selected detector MAXPEAK, MINPEAK, AVERAGE, RMS, QUASIPeAK Scan count Transducer name (if switched on)
<b>Data section of the file Scan ranges</b>	Scan 1: Start;150000.000000;Hz Stop;30000000.000000;Hz Step; 4000.000000;Hz RBW;9000.000000;Hz Meas Time;0.001000;s Auto Ranging;OFF; RF Att;10.000000;dB Auto Preamp;OFF; Preamp;0.000000;dB Scan 2: Start;30000000.000000;Hz Stop;1000000000.000000;Hz Step; 50000.000000;Hz RBW;120000.000000;Hz Meas Time;0.000100;s Auto Ranging;OFF; RF Att;10.000000;dB Auto Preamp;OFF; Preamp;0.000000;dB	Settings for scan range 1 Range 1 - start frequency in Hz Range 1 – stop frequency in Hz Range 1 - step width Range 1 - resolution bandwidth Range 1 - measurement time Range 1 - Auto ranging on - or off Range 1 - input attenuation Range 1 - Auto Preamp on or off Range 1 - preamplifier on (20dB) or off (0dB) Settings for scan range 2 Range 2 - start frequency in Hz Range 2 – stop frequency in Hz Range 2 - step width Range 2 - resolution bandwidth Range 2 - measurement time Range 2 - Auto ranging on - or off Range 2 - input attenuation Range 2 - Auto Preamp on or off Range 2 - preamplifier on (20dB) or off (0dB)
<b>Data section of the file trace</b>	Trace 1: Trace Mode;CLR/WRITE; x-Unit;Hz; y-Unit;dBμV;  Values;26863;  150000.000000;15.604355; 154000.000000;13.236252; 158000.000000;11.907021; ...;...	Selected trace Trace mode: CLR/WRITE, MAXHOLD Unit of x values: Hz for span > 0 Unit of y values: dB*/V/A/W depending on the selected unit Number of test points Measured values: <x value>, <y value>;



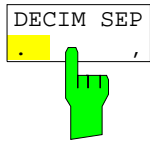

The *DECIM SEP* softkey selects the decimal separator between '.' (decimal point) and ',' (comma) with floating-point numerals for the function ASCII FILE EXPORT.

With the selection of the decimal separator different language versions of evaluation programs (e.g. MS-Excel) can be supported.

IEC/IEEE-bus command `FORM:DEXP:DSEP POIN`

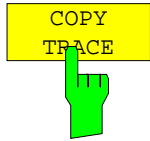

The *COPY TRACE* softkey copies the screen contents of the current trace into another trace memory. The desired memory is selected by entering the number 1, 2 or 3.

Upon copying, the contents of the selected memory is overwritten and the new contents displayed in view mode.

IEC/IEEE-bus command `TRAC:COPY TRACE1,TRACE2`

## Spectrum Analyzer Mode

The analyzer mode is activated by pressing hotkey *SPECTRUM* (see also Section 'Mode Selection')

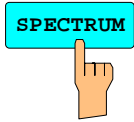

The *SPECTRUM* hotkey selects the *ANALYZER* mode.

This mode is the default setting of the ESPI.

The functions provided correspond to those of a conventional spectrum analyzer. The analyzer measures the frequency spectrum of the test signal over the selected frequency range with the selected resolution and sweep time, or, for a fixed frequency, displays the waveform of the video signal.

**Note:** If two displays (screen A and screen B) are opened after switch-on of signal analysis, the analyzer mode is only set for the display activated for entry (marked at the top right corner of diagram). For the other display, the previous settings remain valid. Data acquisition and display of measured values is sequential: first in the upper and then in the lower display.

### Frequency and Span Selection – *FREQ* Key

The *FREQ* key is used to specify the frequency axis of the active display window. The frequency axis can be defined either by the start and stop frequency or by the center frequency and the span (*SPAN* key). With two windows (*SPLIT SCREEN*) displayed at the same time, the input data always refer to the window selected in the *SYSTEM-DISPLAY* menu.

After pressing one of the *CENTER*, *START* or *STOP* softkeys, the value of the corresponding parameter can be defined in an input window.

*FREQ* menu:

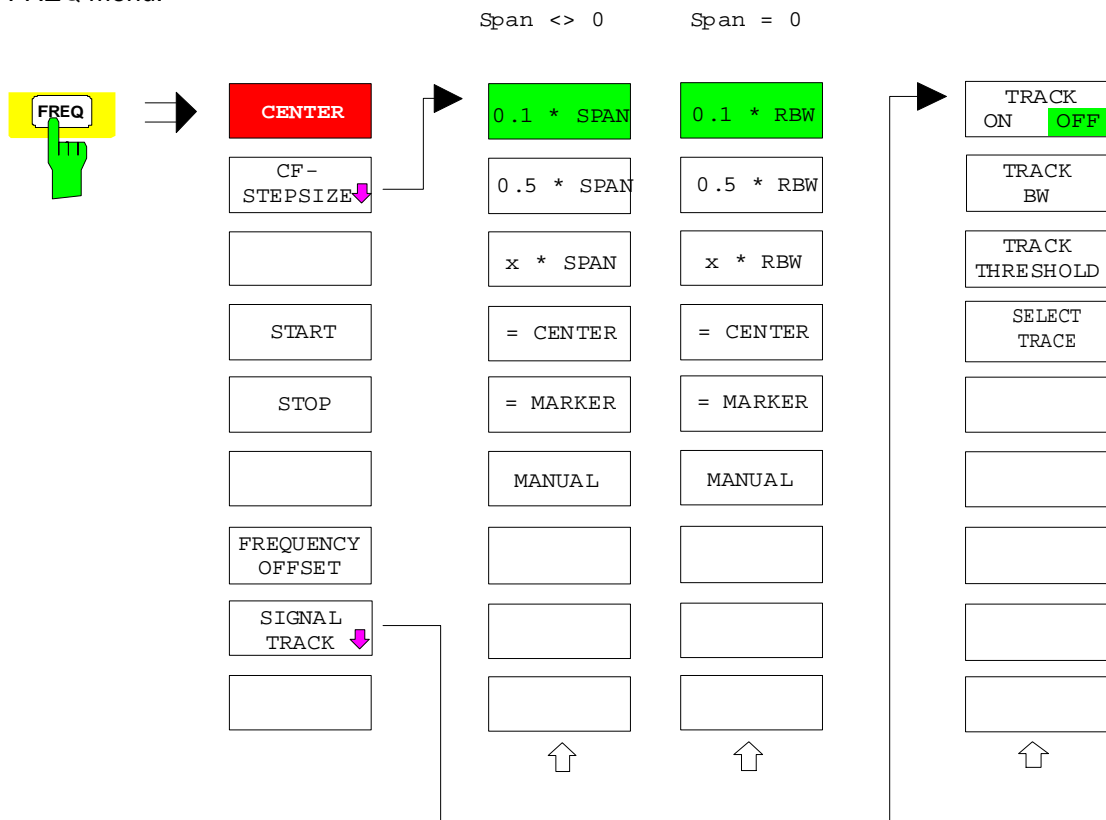



The *CENTER* softkey opens the window for manually entering the center frequency.

The allowed range of values for the center frequency is:

for the frequency domain (span >0):

$$\text{minspan} / 2 \leq f_{\text{center}} \leq f_{\text{max}} - \text{minspan} / 2$$

and for the time domain (span = 0):

$$0 \text{ Hz} \leq f_{\text{center}} \leq f_{\text{max}}$$

$f_{\text{center}}$	center frequency
minspan	smallest selectable span > 0 Hz (10 Hz)
$f_{\text{max}}$	max. frequency

IEC/IEEE-bus command:      `FREQ:CENT 100MHZ`



The *CF STEPSIZE* softkey opens a submenu for setting the step size of the center frequency. The step size can be coupled to the span (frequency domain) or the resolution bandwidth (time domain) or it can be manually set to a fixed value. The softkeys are mutually exclusive selection keys.

The softkeys are presented according to the selected domain (frequency or time).

**Softkeys in frequency domain:**

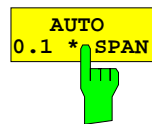

The *0.1 \* SPAN* softkey sets the step size for the center frequency entry to 10% of the span.

IEC/IEEE-bus command:  
`FREQ:CENT:STEP:LINK SPAN`  
`FREQ:CENT:STEP:LINK:FACT 10PCT`

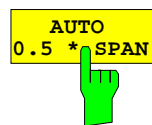

The *0.5 \* SPAN* softkey sets the step size for the center frequency entry to 50% of the span.

IEC/IEEE-bus command:  
`FREQ:CENT:STEP:LINK SPAN`  
`FREQ:CENT:STEP:LINK:FACT 50PCT`

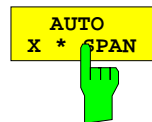

The *X \* SPAN* softkey allows the factor defining the center frequency step size to be entered as % of the span.

IEC/IEEE-bus command:  
`FREQ:CENT:STEP:LINK SPAN`  
`FREQ:CENT:STEP:LINK:FACT 20PCT`

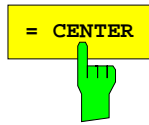

The = *CENTER* softkey sets the step size coupling to *MANUAL* and the step size to the value of the center frequency. This function is especially useful during measurements of the signal harmonic content because by entering the center frequency each stroke of the *STEP* key selects the center frequency of another harmonic.

IEC/IEEE-bus command: --



The = *MARKER* softkey sets the step size coupling to *MANUAL* and the step size to the value of the marker. This function is especially useful during measurements of the signal harmonic content at the marker position because by entering the center frequency each stroke of the *STEP* key selects the center frequency of another harmonic.

IEC/IEEE-bus command: --



The *MANUAL* softkey activates the window for entering a fixed step size.

IEC/IEEE-bus command: `FREQ:CENT:STEP 120MHz`

#### Softkeys in time domain:

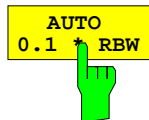

The *0.1 \* RBW* softkey sets the step size for the center frequency entry to 10% of the resolution bandwidth.

*AUTO 0.1 \* RBW* corresponds to the default setting.

IEC/IEEE-bus command:

```
FREQ:CENT:STEP:LINK RBW
FREQ:CENT:STEP:LINK:FACT 10PCT
```

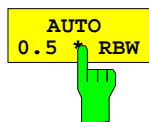

The *0.5 \* RBW* softkey sets the step size for the center frequency entry to 50% of the resolution bandwidth.

IEC/IEEE-bus command:

```
FREQ:CENT:STEP:LINK RBW
FREQ:CENT:STEP:LINK:FACT 50PCT
```

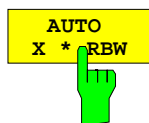

The *X \* RBW* softkey allows the factor defining the center frequency step size to be entered as % of the resolution bandwidth.

Values between 1 and 100% in steps of 1% are allowed. The default setting is 10%.

IEC/IEEE-bus command:

```
FREQ:CENT:STEP:LINK RBW
FREQ:CENT:STEP:LINK:FACT 20PCT
```

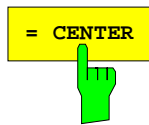

The = *CENTER* softkey sets the step size coupling to *MANUAL* and the step size to the value of the center frequency. This function is especially useful during measurements of the signal harmonic content because by entering the center frequency each stroke of the *STEP* key selects the center frequency of another harmonic.

IEC/IEEE-bus command: --



The = *MARKER* softkey sets the step size coupling to *MANUAL* and the step size to the value of the marker. This function is especially useful during measurements of the signal harmonic content at the marker position because by entering the center frequency each stroke of the *STEP* key selects the center frequency of another harmonic.

IEC/IEEE-bus command: --

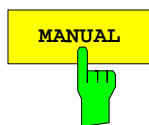

The *MANUAL* softkey activates the window for entering a fixed step size.

IEC/IEEE-bus command:  
FREQ:CENT:STEP 120MHz

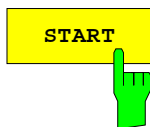

The *START* softkey activates the window for manually entering the start frequency.

The allowed range of values for the start frequency is:

$$0 \text{ Hz} \leq f_{\text{start}} \leq f_{\text{max}} - \text{minspan}$$

$f_{\text{start}}$  start frequency  
 $\text{minspan}$  smallest selectable span (10 Hz)  
 $f_{\text{max}}$  max. frequency

IEC/IEEE-bus command: FREQ:STAR 20MHz

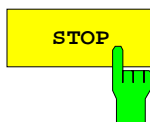

The *STOP* softkey activates the window for entering the .

The allowed range of values for the stop frequency is:

$$\text{minspan} \leq f_{\text{stop}} \leq f_{\text{max}}$$

$f_{\text{stop}}$  stop frequency  
 $\text{minspan}$  smallest selectable span (10 Hz)  
 $f_{\text{max}}$  max. frequency

IEC/IEEE-bus command: FREQ:STOP 2000MHz

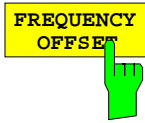

The *FREQUENCY OFFSET* softkey activates the window for entering an arithmetical frequency offset which is added to the frequency axis labelling. The allowed range of values for the offset is -100 GHz to 100 GHz. The default setting is 0 Hz.

IEC/IEEE-bus command: `FREQ:OFFS 10 MHz`



The *SIGNAL TRACK* softkey switches on the tracking of a signal near the center frequency. The signal is tracked as long it is in the search bandwidth around the center frequency defined with *TRACK BW* and above the level threshold defined with *TRACK THRESHOLD*.

For that purpose, the maximum signal is searched (*PEAK SEARCH*) on the screen and the center frequency set to this signal (*MARKER ->CENTER*) after each frequency sweep within the search bandwidth.

If the signal falls below the level threshold or jumps out of the search bandwidth around the center frequency, the center frequency is not varied until a signal is in the search bandwidth above the level threshold. This can be achieved by manually modifying the center frequency, for example.

On switching on, the softkey is highlighted and the search bandwidth and the threshold value are marked on the diagram by two vertical lines and one horizontal line. All these lines are allocated the designation TRK.

At the same time a submenu is opened in which the search bandwidth, the threshold value and the trace can be modified for the maximum search.

The softkey is only available in the frequency domain (span >0).

IEC/IEEE-bus command: `CALC:MARK:FUNC:STR OFF`



The *TRACK ON/OFF* softkey switches on and off signal tracking.

IEC/IEEE-bus command: `CALC:MARK:FUNC:STR OFF`

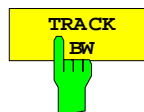

The *TRACK BW* softkey defines the search bandwidth for signal tracking. The frequency range is symmetrical with respect to the center frequency.

IEC/IEEE-bus command:

`CALC:MARK:FUNC:STR:BAND 10KHZ`



The *TRACK THRESHOLD* softkey defines the threshold value for signal detection. The value is always entered as an absolute level value.

IEC/IEEE-bus command:

`CALC:MARK:FUNC:STR:THR -70DBM`

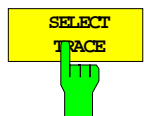

The *SELECT TRACE* softkey selects the trace on which signal tracking is to be performed.

IEC/IEEE-bus command:

`CALC:MARK:FUNC:STR:TRAC 1`

## Setting the Frequency Span – SPAN Key

SPAN menu

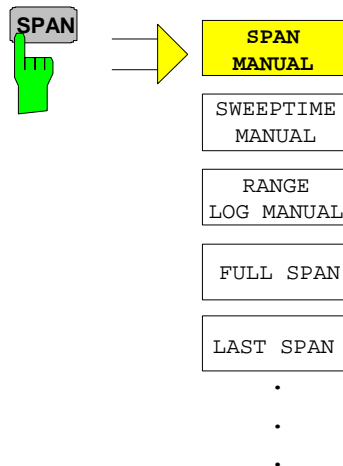

The *SPAN* key opens a menu which offers various options for setting the span.

The entry of the span (*SPAN MANUAL* softkey) is automatically active for span > 0 Hz.

For span = 0 Hz the entry for sweep time (*SWEEPTIME MANUAL*) is automatically active.

With two windows (*SPLIT SCREEN*) displayed at the same time, the input data always refer to the window selected with hotkey *SCREEN A/B*.

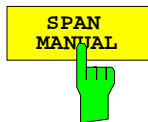

The *SPAN MANUAL* softkey activates the window for manually entering the frequency span. The center frequency is kept constant.

The allowed range of span values is for the time domain (span = 0): 0 Hz and for the frequency domain (span >0):  $minspan \leq f_{span} \leq f_{max}$

$f_{span}$	frequency span
$minspan$	smallest selectable span (10 Hz)
$f_{max}$	max. frequency

IEC/IEEE-bus command      `FREQ:SPAN 2GHz`

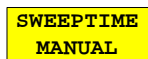

The *SWEEPTIME MANUAL* softkey activates the window for entering the sweep time manually with Span = 0 Hz. The softkey is not available for Span > 0 Hz.

IEC/IEEE-bus command:      `SWE:TIME 10s`

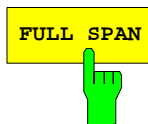

The *FULL SPAN* softkey sets the span to the full frequency range of ESPI.

IEC/IEEE-bus command      `FREQ:SPAN:FULL`

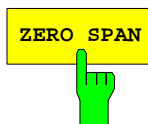

The *ZERO SPAN* softkey sets the span to 0 Hz. The x axis becomes the time axis with the grid lines corresponding to 1/10 of the current sweep time (SWT).

IEC/IEEE-bus command      `FREQ:SPAN 0Hz`



After changing the span setting the *LAST SPAN* softkey activates the previous setting. With this function a fast change between overview measurement (*FULL SPAN*) and detailed measurement (manually set center frequency and span) is possible.

**Note:** Only values > 0 Hz are restored, i.e. a transition between time and frequency domain is not possible.

IEC/IEEE-bus command      `---`

### Level Display Setting and RF Input Configuration – AMPT Key

The *AMPT* key is used to set the reference level, the maximum level and the display range of the active window as well as the input impedance and the input attenuation of the RF input.

The *AMPT* key opens a menu for setting the reference level and the input attenuation of the active window. The data entry for the reference level (*REF LEVEL* softkey) is opened automatically.

Further settings regarding level display and attenuation can be made in this menu.

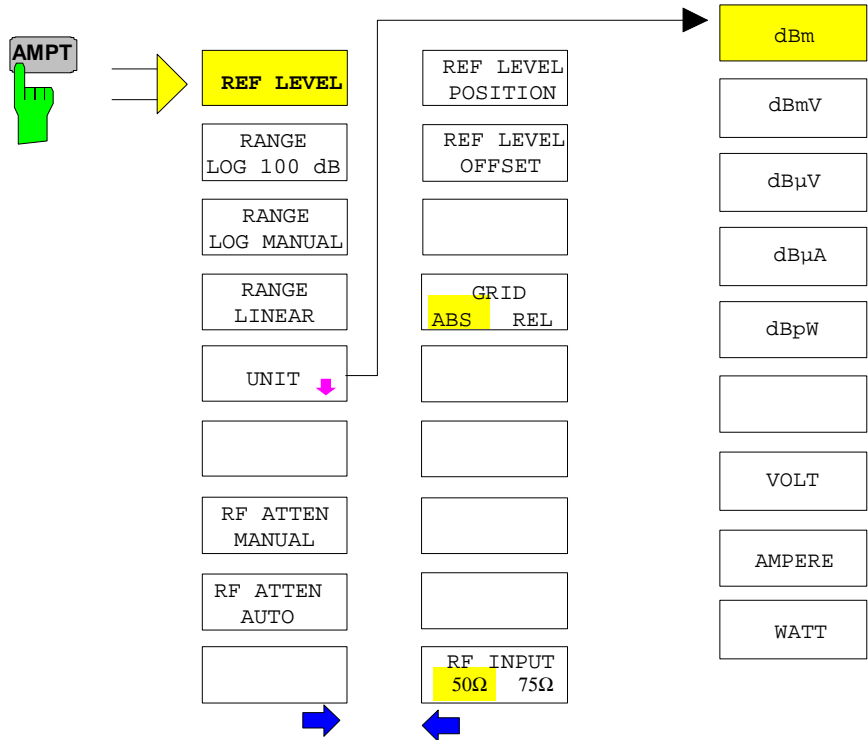

The *REF LEVEL* softkey allows the reference level to be input in the currently active unit (dBm, dBµV, etc).

IEC/IEEE-bus command: `DISP:WIND:TRAC:Y:RLEV -60dBm`

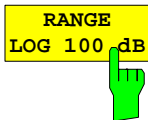

The *RANGE LOG 100 dB* softkey sets the level display range to 100 dB.

IEC/IEEE-bus command: `DISP:WIND:TRAC:Y:SPAC LOG`  
`DISP:WIND:TRAC:Y 100DB`



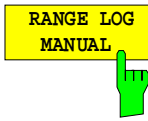

The *RANGE LOG MANUAL* softkey activates the manual entry of the level display range. Display ranges from 10 to 200 dB are allowed in 10 dB steps. Inputs which are not allowed are rounded to the next valid value.

The default setting is 100 dB.

IEC/IEEE-bus command:        `DISP:WIND:TRAC:Y:SPAC LOG`  
                                       `DISP:WIND:TRAC:Y 120DB`

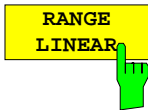

The *RANGE LINEAR* softkey switches the display range of the analyzer to linear scaling. The horizontal lines are labelled in %. The grid has a decadic scaling.

IEC/IEEE-bus command:        `DISP:WIND:TRAC:Y:SPAC LIN`

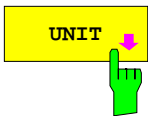

- dBm
- dBmV
- dBμV
- dBμA
- dBpW
- 
- VOLT
- AMPERE
- WATT

The *UNIT* softkey opens a sub menu allowing to select the unit for the level axis.

The default setting is dBm.

In general, the spectrum analyzer measures the signal voltage at the RF input. The level display is calibrated in rms values of an unmodulated sinewave signal. In the default state, the level is displayed at a power of 1 mW (= dBm). Via the known input resistance of 50 Ω or 75Ω , conversion to other units is possible. The units dBm, dBmV, dBμV, dBμA, dBpW, V, A and W are directly convertible.

IEC/IEEE-bus command:        `CALC:UNIT:POW DBM`

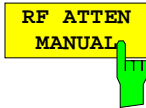

The *RF ATTEN MANUAL* softkey allows the attenuation to be entered irrespective of the reference level.

The attenuation can be set in 10 dB steps between 0 and 70 dB. Other entries will be rounded to the next lower integer value.

If the defined reference level cannot be set for the given RF attenuation, the reference level will be adjusted accordingly and the warning "Limit reached" will be output.

**Note:** *The 0-dB value can be entered only via the numeric keypad in order to protect the input mixer against occasional overload.*

IEC/IEEE-bus command:        INP:ATT 40 DB



The *RF ATTEN AUTO* softkey sets the RF attenuation automatically as a function of the selected reference level.

This ensures that the optimum RF attenuation desired by the user is always used.

*RF ATTEN AUTO* is the default setting.

IEC/IEEE-bus command:        INP:ATT:AUTO ON

AMPT – NEXT menu:



The *REF LEVEL POSITION* softkey allows the reference level position to be entered.

The setting range is from -200 to +200%, 0% corresponding to the lower and 100% to the upper limit of the diagram.

IEC/IEEE-bus command:        DISP:WIND:TRAC:Y:RPOS 100PCT



The *REF LEVEL OFFSET* softkey allows the arithmetic level offset to be entered. This offset is added to the measured level irrespective of the selected unit. The scaling of the Y axis is changed accordingly.

The setting range is  $\pm 200$  dB in 0.1 dB steps.

IEC/IEEE-bus command:        DISP:WIND:TRAC:Y:RLEV:OFFS -10dB

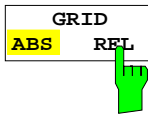

The *GRID ABS/REL* softkey switches between absolute and relative scaling of the level axis.

*GRID ABS* is the default setting.

*ABS* The labelling of the level lines refers to the absolute value of the reference level.

*REL* The upper line of the grid is always at 0 dB.  
The scaling is in dB whereas the reference level is always in the set unit (dBm, dB $\mu$ V,..).

For setting *RANGE LINEAR* (linear scaling, labelling of axes in %) the softkey is not displayed since the unit % itself implies a relative scale.

IEC/IEEE-bus command:        `DISP:WIND:TRAC:Y:MODE ABS`

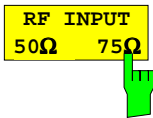

The *RF INPUT 50  $\Omega$  / 75  $\Omega$*  softkey switches the input impedance of the instrument between 50  $\Omega$  (= default setting) and 75  $\Omega$ .

The setting 75  $\Omega$  should be used if the input impedance (50  $\Omega$ ) is transformed to 75  $\Omega$  using the corresponding adapter unit of type RAZ (= 25  $\Omega$  in series to the input impedance of the analyzer). The correction value used for the adaption is 1.76 dB = 10 log ( 75 $\Omega$  / 50 $\Omega$ ).

All levels specified in this operating manual refer to the default setting of the instrument (50  $\Omega$ ).

IEC/IEEE-bus command:        `INP:IMP 50OHM`

## Setting the Bandwidths and Sweep Time – BW Key

The *BW* key calls a menu for setting the resolution bandwidth (*RBW*), video bandwidth (*VBW*) and sweep time (*SWT*) for the frequency sweep. The parameters may be coupled dependent on the span (stop minus start frequency) or freely set by the user. When working with a split screen display, the settings always refer to the active window.

The ESPI offers resolution bandwidths from 10 Hz to 10 MHz in 1, 3, 10 steps:

Resolution bandwidths up to 100 kHz are realized using digital bandpasses with Gaussian characteristics. As far as the attenuation characteristic is concerned they behave like analog filters but have a much higher measurement speed than comparable analog filters. This is due to the fact that the transient response can be compensated as a result of an accurately defined filter behaviour.

Bandwidths above 100 kHz are realized using decoupled 4-circuit LC filters.

As an alternative to the analog filters, FFT filters are available for the bandwidths between 1 Hz and 30 kHz. When working with bandwidths up to 30 kHz, the FFT algorithm offers considerably higher measurement speeds with all the other settings remaining the same. The reason is that with analog filters the sweep time required for a particular span is proportional to  $(\text{Span}/\text{RBW}^2)$ . When using the FFT algorithm, however, the sweep time is proportional to  $(\text{Span}/\text{RBW})$ .

The video bandwidths are available in 1, 3, 10 steps between 1 Hz and 10 MHz. They can be set in accordance with the resolution bandwidth.

The video filters serve for smoothing the displayed trace. Video bandwidths that are small compared to the resolution bandwidth average out noise peaks and pulsed signals, so that only the signal average is displayed. If pulsed signals are to be measured, it is recommended to use a video bandwidth that is large compared to the resolution bandwidth ( $\text{VBW} \geq 10 \times \text{RBW}$ ) for the amplitudes of pulses to be measured correctly.

**Note:** *For analog and digital filters, the ESPI has overload reserves of different magnitude above the reference level. Due to the LO breakthrough the overload display OVLD responds with digital filters with  $\text{RBW} < 100 \text{ kHz}$ , as soon as the start frequency is selected  $< 6 \times$  resolution bandwidth, for  $\text{RBW} = 100 \text{ kHz}$ , as soon as the start frequency is below 3 MHz.*

BW menu:

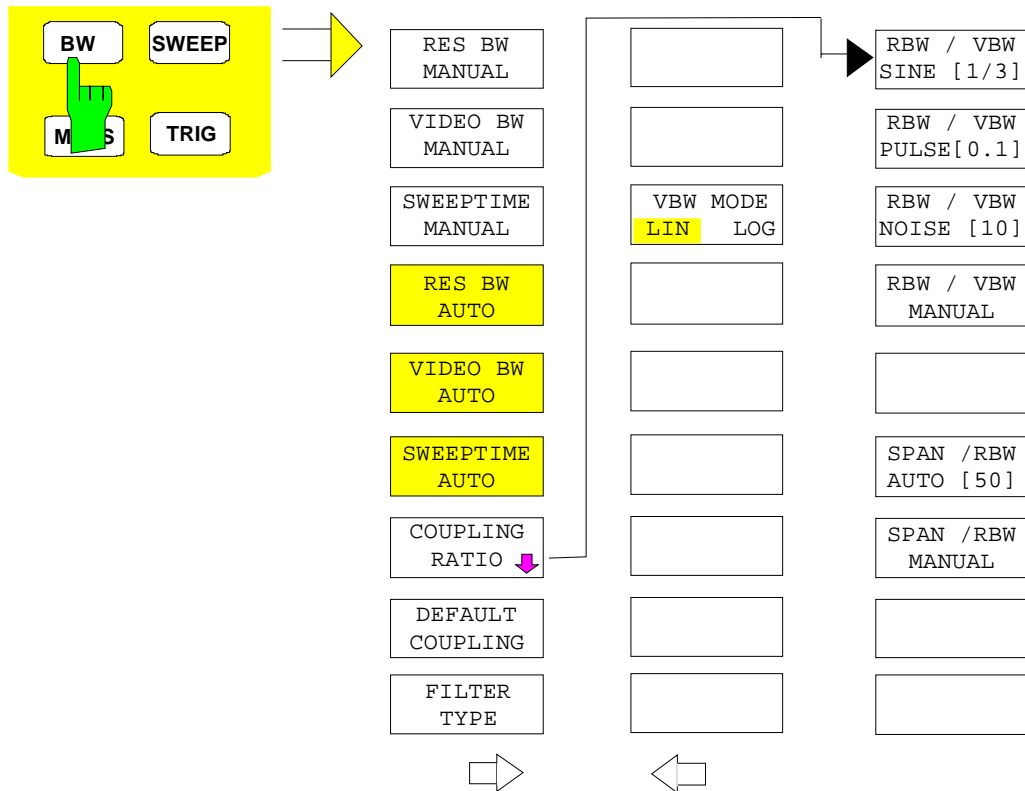

The *BW* key calls a menu for setting the resolution bandwidth, video bandwidth, sweep time and their couplings.

The various .. *BW AUTO* softkeys are used to couple the functions. The coupling ratios are selected by the *COUPLING RATIO* softkey. The .. *BW MANUAL* softkeys enable the entry of the parameter concerned. This parameter is not coupled to the other parameters.

**Note:** *With the ... BW AUTO softkeys the resolution bandwidth, the video bandwidth and the sweep time can be entered separately for the frequency domain (span > 0 Hz) and the time domain (span = 0 Hz). But with ...BW MANUAL softkeys the selected values apply to both the frequency and time domain.*

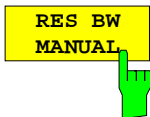

The *RES BW MANUAL* softkey activates the manual data entry for the resolution bandwidth.

The resolution bandwidth can be selected in 1/3/10 steps in the range between 10 Hz and 10 MHz. The nominal resolution bandwidth is the 3 dB bandwidth.

When FFT filters are used, the lower limit of the bandwidth is 1 Hz. FFT filters may be used with bandwidths up to 30 kHz.

For numeric inputs, the values are always rounded to the nearest possible bandwidth. For rollkey or UP/DOWN key inputs, the bandwidth is adjusted in steps either upwards or downwards.

For filter type CHANNEL or RRC the bandwidth is selected from the list of available channel filters given at the end of this chapter. For data entry, the cursor keys ↑ and ↓ scroll through this list.

The manual input mode of the resolution bandwidth is indicated by a green terisk (\*) on the display.

IEC/IEEE-bus command: BAND:AUTO OFF;BAND 1MHz



VIDEO BW  
MANUAL

The *VIDEO BW MANUAL* softkey activates the manual data entry for the video bandwidth.

The video bandwidth can be selected in 1/3/10 steps in the range between 1 Hz and 10 MHz. For numeric inputs, the values are always rounded to the nearest possible allowed bandwidth. For rollkey or UP/DOWN key inputs, the bandwidth is adjusted in steps either downwards or upwards.

The manual input mode of the video bandwidth is indicated by a green terisk (\*) on the display.

IEC/IEEE-bus command:      BAND:VID:AUTO OFF;  
                                      BAND:VID 10 kHz

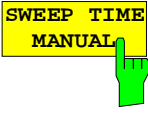

SWEEP TIME  
MANUAL

The *SWEEP TIME MANUAL* softkey activates the manual data entry for the sweep time. At the same time, the coupling of the sweep time is cancelled. Other couplings (*VIDEO BW*, *RES BW*) remain effective.

In the frequency domain (span > 0 Hz) and for resolution bandwidths above 1 kHz, the allowed sweep times for spans > 3.2 kHz range from 2.5 ms through to 16000 s. With spans below 3.2 kHz, the maximum allowed sweep time is reduced to 5 s \* span/Hz.

If FFT filters are used, the sweep time is fixed by the span and the bandwidth and therefore cannot be set.

In time domain (span = 0 Hz), the range of sweep times is 1 µs to 16000 s is selectable in steps of max. 5% of the sweep time. For numeric inputs, rounding is made to the nearest possible sweep time. For rollkey or UP/DOWN key inputs, the sweep time is adjusted in steps either downwards or upwards.

The manual input mode of the sweep time is indicated by a green asterisk (\*) on the display. If the selected sweep time is too short for the selected bandwidth and span, level measurement errors will occur. This happens because the available settling time for the resolution or video filters is too short. In this case, the ESPI outputs *UNCAL* on the display and marks the indicated sweep time with a red asterisk (\*).

IEC/IEEE-bus command:      SWE:TIME:AUTO OFF;  
                                      SWE:TIME 10s



RES BW  
AUTO

The *RES BW AUTO* softkey couples the resolution bandwidth to the selected span. Changing the span causes automatic adjustment of the resolution bandwidth.

Automatic coupling of resolution bandwidth to span is always recommended when a favourable setting of the resolution bandwidth in relation to the selected span is desired for the measurement under request.

The coupling ratio is set in the *COUPLING RATIO* submenu.

The *RES BW AUTO* softkey is only available in the frequency domain (span > 0 Hz). The softkey is blanked in the time domain.

IEC/IEEE-bus command:      BAND:AUTO ON

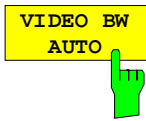

The *VIDEO BW AUTO* softkey couples the video bandwidth to the resolution bandwidth. If the resolution bandwidth is changed, the video bandwidth is automatically adjusted.

The coupling of the video bandwidth is always recommended when the minimum sweep time is required for a selected resolution bandwidth. Narrower video bandwidths require longer sweep times due to the longer settling time. Wider bandwidths reduce the signal/noise ratio.

The coupling ratio is set in the *COUPLING RATIO* submenu.

The coupling of the video bandwidth to the resolution filter is also permitted for the time domain display (span = 0).

IEC/IEEE-bus command: `BAND:VID:AUTO ON`

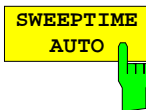

The *SWEPTIME AUTO* softkey couples the sweep time to the span, video bandwidth (VBW) and resolution bandwidth (RBW). The sweep time is automatically adjusted on any change in span, resolution bandwidth or video bandwidth.

The softkey is only available in the frequency domain (span >0 Hz). It is blanked in the time domain.

The ESPI always selects the shortest sweep time possible without falsifying the signal. The maximum level error compared to using a longer sweep time is < 0.1 dB. If additional bandwidth and level errors are to be avoided, the sweep time is to be set to three times the time offered in coupled mode.

IEC/IEEE-bus command: `SWE:TIME:AUTO ON`

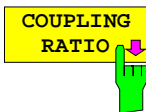

RBW / VBW  
SINE [1/3]

RBW / VBW  
PULSE [.1]

RBW / VBW  
NOISE [10]

RBW / VBW  
MANUAL

[ ]

SPAN / RBW  
AUTO [50]

SPAN / RBW  
MANUAL

[ ]

[ ]

The *COUPLING RATIO* softkey opens a sub menu for selection of the coupling ratios.

When the default setting is active, ie the *COUPLING RATIO* softkey is deactivated (not highlighted), the ratio span/resolution bandwidth (SPAN/RBW) is 50 (this corresponds to SPAN / RBW AUTO [50]) and the ratio resolution bandwidth/video bandwidth (RBW/VBW) is 0.33 (this corresponds to RBW / VBW SINE [1/3]).

If the ratio RBW/VBW or SPAN/RBW is different from the default setting, the *COUPLING RATIO* softkey is highlighted.

The softkeys RBW/VBW... are selection keys. Only one softkey can be enabled at any one time. The softkeys are only effective for the *VBW AUTO* selection in the main menu.

The softkeys SPAN/RBW... are also selection keys. They are only effective for the *RBW AUTO* selection in the main menu.

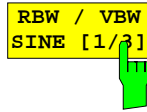

The *RBW/VBW SINE [1/3]* softkey sets the following coupling ratio:

video bandwidth = 3 x resolution bandwidth.

This is the default setting for the coupling ratio resolution bandwidth/video bandwidth. It is the coupling ratio recommended if sinusoidal signals are to be measured.

IEC/IEEE-bus command `BAND:VID:RAT 3`

This setting is only effective for the *VBW AUTO* selection in the main menu.

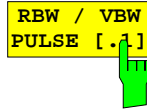

The *RBW/VBW PULSE [.1]* softkey sets the following coupling ratio:

video bandwidth = 10 x resolution bandwidth or  
video bandwidth = 10 MHz (= max. VBW).

This coupling ratio is recommended whenever the amplitudes of pulsed signals are to be measured correctly. The IF filter is exclusively responsible for pulse shaping. No additional evaluation is performed by the video filter.

IEC/IEEE-bus command `BAND:VID:RAT 10`

This setting is only effective for the *VBW AUTO* selection in the main menu.

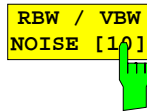

The *RBW/VBW NOISE [10]* softkey sets the following coupling ratio:

video bandwidth = resolution bandwidth/10

At this coupling ratio, noise and pulsed signals are suppressed in the video domain. For noise signals, the average value is displayed.

IEC/IEEE-bus command `BAND:VID:RAT 0.1`

This setting is only effective for the *VBW AUTO* selection in the main menu.

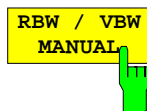

The *RBW/VBW MANUAL* softkey activates the manual input of the coupling ratio.

The resolution bandwidth/video bandwidth ratio can be set in the range 0.001 to 1000.

IEC/IEEE-bus command `BAND:VID:RAT 10`

This setting is only effective for the *VBW AUTO* selection in the main menu.

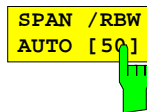

The *SPAN/RBW AUTO [50]* softkey sets the following coupling ratio:

resolution bandwidth = span/50

This coupling ratio is the default setting of the ESPI

IEC/IEEE-bus command `BAND:RAT 0.02`

This setting is only effective for the *RBW AUTO* selection in the main menu.



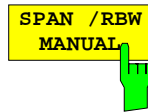

The *SPAN/RBW MANUAL* softkey activates the manual input of the coupling ratio.

The span / resolution bandwidth ratio can be set in the range 1 to 10000.

IEC/IEEE-bus command `BAND:RAT 0.1`

This setting is only effective for the *RBW AUTO* selection in the main menu.

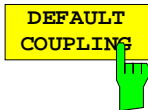

The *DEFAULT COUPLING* softkey sets all coupled functions to the default state (*AUTO*). In addition, the ratio *RBW/VBW* is set to *SINE [1/3]* and the ratio *SPAN/RBW* to 50 in the *COUPLING RATIO* submenu (default setting, *COUPLING RATIO* softkey not highlighted).

IEC/IEEE-bus command `BAND:AUTO ON`  
`BAND:VID:AUTO ON`  
`SWE:TIME:AUTO ON`

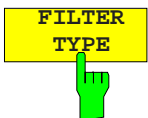

The *FILTER TYPE* softkey opens the selection list for different filter types. In the range up to 30 kHz digital band filters with Gaussian characteristic and filtering with FFT algorithm can be selected.

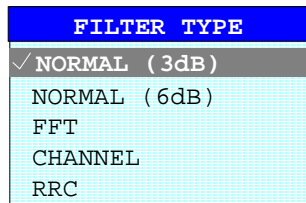

**NORMAL(3dB)** The resolution bandwidths are implemented by Gaussian filters with the set 3 dB bandwidth and correspond approximately to the noise bandwidth. For bandwidths up to 100 kHz, digital bandpass filters are used.

**NORMAL(6dB)** The resolution bandwidths are implemented by Gaussian filters with the set 6 dB bandwidth and correspond approximately to the pulse bandwidth. For bandwidths up to 120 kHz, digital bandpass filters are used.

**FFT** An FFT is performed. For that purpose, the filtered IF signal is digitized and then transformed into the spectral domain via FFT. The transformation range depends on the selected filter bandwidths and can be set between 4 kHz to 50 kHz. If the span is larger than the transformation range, several transformations are performed and the results are appended to each other in the spectral domain. If the span is smaller than the transformation range, the measurement results are interpolated when the number of measurement points provided by the FFT is smaller than the number of display points in x-direction (501). A flattop window serves as a window in the time domain so that high amplitude precision with good selection is achieved. A flattop window serves as a window in the time domain so that high amplitude accuracy as well as good selection are achieved.

Sweep time	Defined by the selected bandwidth and span (reason: FFT filtering is a block transformation). It cannot be changed (softkey deactivated).
Detector	Sample detector and peak detector are available. Peak detector is active when AUTO SELECT is selected.
Video bandwidth	Not defined in case of FFT; therefore cannot be set (softkeys deactivated).

Compared to bandpasses, FFT filters lead to significantly reduced sweep times. For a span of 50 kHz and a bandwidth of 100 Hz, for instance, the sweep time is reduced from 5 s to 40 ms. FFT filters are particularly suitable for stationary signals (sinusoidal signals or signals that are continuously modulated in time). For burst signals (TDMA) or pulsed signals, normal filters are preferable.

**Note:**

*As soon as the FFT filters are active ( $RBW \leq 30$  kHz) the sweep time display field (SWT) is replaced by the acquisition time (AQT) display field.*

*FFT is a block transformation so the result depends on the time relation between the dataset to be transformed and the burst or pulsed signal. A gated sweep measurement for TDMA signals is therefore not provided if FFT filters are used.*

*When the tracking generator (option FSP-B9) is used as signal source for the DUT, filtering with the FFT algorithm is not useful. The selection FFT is thus not available if the tracking generator is switched on.*

Additionally, a number of especially steep-edged channel filters are available for power measurement since firmware version 1.10.

A distinction is made between the following filter types:

CHANNEL = general, steep-edged channel filters  
 RRC = filters with root-raised cosine characteristic  
 (RRC = Root Raised Cosine)

When selecting these filter types, the automatic coupling of the resolution bandwidth to the span is not available. The filters are selected via the *RES BW* softkey.

A list of all available channel filters with their associated applications can be found at the end of this chapter.

IEC/IEEE-bus command: BAND:TYPE NORM

**List of available channel filters**

The channel filters included in the following table are can be activated via the *FILTER TYPE* softkey and are then available as resolution filters (softkey *RES* available for firmware version 1.10 or higher. They *BW*).

**Note:**

For filters of type *RRC* (Root Raised Cosine), the filter bandwidth indicated describes the sampling rate of the filter.

For all other filters (*CFILter*) the filter bandwidth is the 3 dB bandwidth.

Filter Bandwidth	Filter Type	Application
100 Hz 200 Hz 300 Hz 500 Hz	CFILter CFILter CFILter CFILter	A0
1 kHz 1.5 kHz 2 kHz 2.4 kHz 2.7 kHz 3 kHz 3.4 kHz 4 kHz 4.5 kHz 5 kHz 6 kHz 8.5 kHz 9 kHz	CFILter CFILter CFILter CFILter CFILter CFILter CFILter CFILter CFILter CFILter CFILter CFILter CFILter	SSB  DAB, Satellite  ETTS300 113 (12.5 kHz channels) AM Radio
10 kHz 12.5 kHz 14 kHz 15 kHz 16 kHz 18 kHz, $\alpha=0.35$ 20 kHz 21 kHz 24.3 kHz, $\alpha=0.35$ 25 kHz 30 kHz 50 kHz	CFILter CFILter CFILter CFILter RRC CFILter CFILter RRC CFILter CFILter CFILter	CDMAone ETTS300 113 (20 kHz channels) ETTS300 113 (25 kHz channels) TETRA PDC IS 136 CDPD, CDMAone
100 kHz 150 kHz 192 kHz 200 kHz 300 kHz 500 kHz	CFILter CFILter CFILter CFILter CFILter	FM Radio PHS  J.83 (8-VSB DVB, USA )
1.0 MHz 1.2288 MHz 1.5 MHz 2.0 MHz *) 3.0 MHz *) 3.84 MHz, $\alpha=0.22$ *) 4.096 MHz, $\alpha=0.22$ *) 5.0 MHz*)	CFILter CFILter CFILter CFILter CFILter RRC RRC CFILter	CDMAone CDMAone DAB  W-CDMA 3GPP W-CDMA NTT DOCoMo

\*) requires IF filter model index  $\geq 3$

BW – NEXT menu:

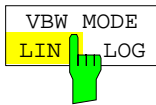

The *VBW MODE LIN/LOG* softkey selects the position of the video filter in the signal path for resolution bandwidths  $\leq 100$  kHz:

**LINear** The video filter is situated in front of the logarithmic amplifier (default)

**LOGarithmic** The video filter is situated behind the logarithmic amplifier

The major difference between the two operating modes is related to the settling behaviour in case of falling signal edges:

With **LINear**, the falling signal edge will be "flatter" than with **LOGarithmic**. This is due to the conversion of linear power to logarithmic level units: a reduction of the linear power by 50% reduces the logarithmic signal level by only 3 dB.

IEC/IEEE-bus command: `BAND:VID:TYPE LIN`

## Sweep Settings – SWEEP Key

The SWEEP key serves for configuring the sweep mode.

SWEEP menu

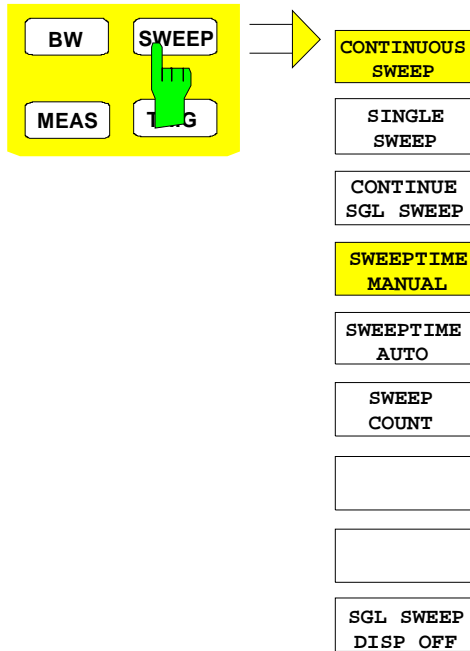

The SWEEP key calls a menu in which the sweep mode is defined. In split-screen mode, the entries made are valid for the active window only.

The CONTINUOUS SWEEP, SINGLE SWEEP and SGL SWEEP DISP OFF softkeys are mutually exclusive selection keys.

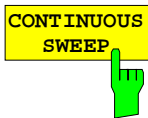

The CONTINUOUS SWEEP softkey activates the continuous sweep mode, which means that the sweep takes place continuously according to the trigger mode set.

When working in the split-screen mode and with different settings in the two windows, screen A is swept first, followed by screen B. When the softkey is pressed, the sweep is restarted.

CONTINUOUS SWEEP is the default setting of ESPI.

IEC/IEEE-bus command: INIT:CONT ON

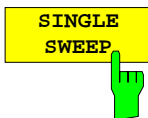

The SINGLE SWEEP softkey starts n sweeps after triggering. The number of sweeps is determined by the SWEEP COUNT softkey.

When working in the split-screen mode, the frequency ranges of the two windows are swept one after the other.

If a trace is swept using TRACE AVERAGE or MAXHOLD, the value set via the SWEEP COUNT softkey determines the number of sweeps. If 0 has been entered, one sweep is performed.

IEC/IEEE-bus command: INIT:CONT OFF

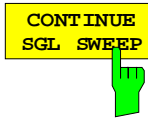

The *CONTINUE SGL SWEEP* softkey repeats the number of sweeps set under *SWEEP COUNT*, however without first deleting the trace.

This is particularly of interest when using the functions *TRACE AVERAGE* and *MAXHOLD*, if previously recorded measurement results are to be taken into consideration for averaging / maximum search.

If *SGL SWEEP DISP OFF* is active, the screen is switched off also during repeated sweeps.

IEC/IEEE-bus command:        `INIT:CONM`



The *SWEPTIME MANUAL* softkey activates the window for entering the sweep time manually (see also BW menu).

IEC/IEEE-bus command:        `SWE:TIME 10s`



The *SWEPTIME AUTO* softkey activates the automatic selection of the sweep time as a function of the bandwidth of the resolution and video filters (see also BW menu).

IEC/IEEE-bus command:        `SWE:TIME:AUTO ON`



The *SWEEP COUNT* softkey activates the window for the entry of the number of sweeps to be performed by ESPI after a single sweep has been started. If Trace Average, Max Hold or Min Hold is activated, this also determines the number of averaging or maximum search procedures.

Example:

`[TRACE1: MAX HOLD]`

`[SWEEP: SWEEP COUNT: {10} ENTER]`

`[SINGLE SWEEP]`

ESPI performs the Max Hold function over 10 sweeps.

The permissible range for the sweep count is 0 to 32767. For sweep count = 0 or 1, one sweep is performed. For trace averaging in the continuous-sweep mode, ESPI performs running averaging over 10 sweeps if sweep count = 0; if sweep count = 1, no averaging is performed.

The sweep count is valid for all the traces in a diagram.

**Note:**        *The number of sweeps set in the TRACE menu is the same as that in the SWEEP menu.*

*If SINGLE SWEEP is selected, the measurement stops after the selected number of sweeps has been performed.*

IEC/IEEE-bus command:        `SWE:COUN 64`



The *SGL SWEEP DISP OFF* softkey deactivates the display while a single sweep is being performed. Once the sweep has been completed, the trace is shown.

IEC/IEEE-bus command:        `INIT:DISP OFF;:INIT`

## Triggering the Sweep– TRIG Key

The *TRIG* key opens a menu for selection of the various trigger sources, trigger polarity and external gate function. The active trigger mode is indicated by highlighting the corresponding softkey.

For video trigger, a trigger threshold can be entered, which is represented in the diagram as a horizontal line.

To indicate that a trigger mode other than *FREE RUN* has been set, the enhancement label **TRG** is displayed on the screen. If two windows are displayed, TRG appears next to the appropriate window.

Option *TV- and RF-Trigger* (FSP-B6) adds a number of trigger functions for the analysis of TV signals to this menu (see section Option FSP-B6 - TV- and RF-Trigger, page 4.90).

### TRIGGER menu

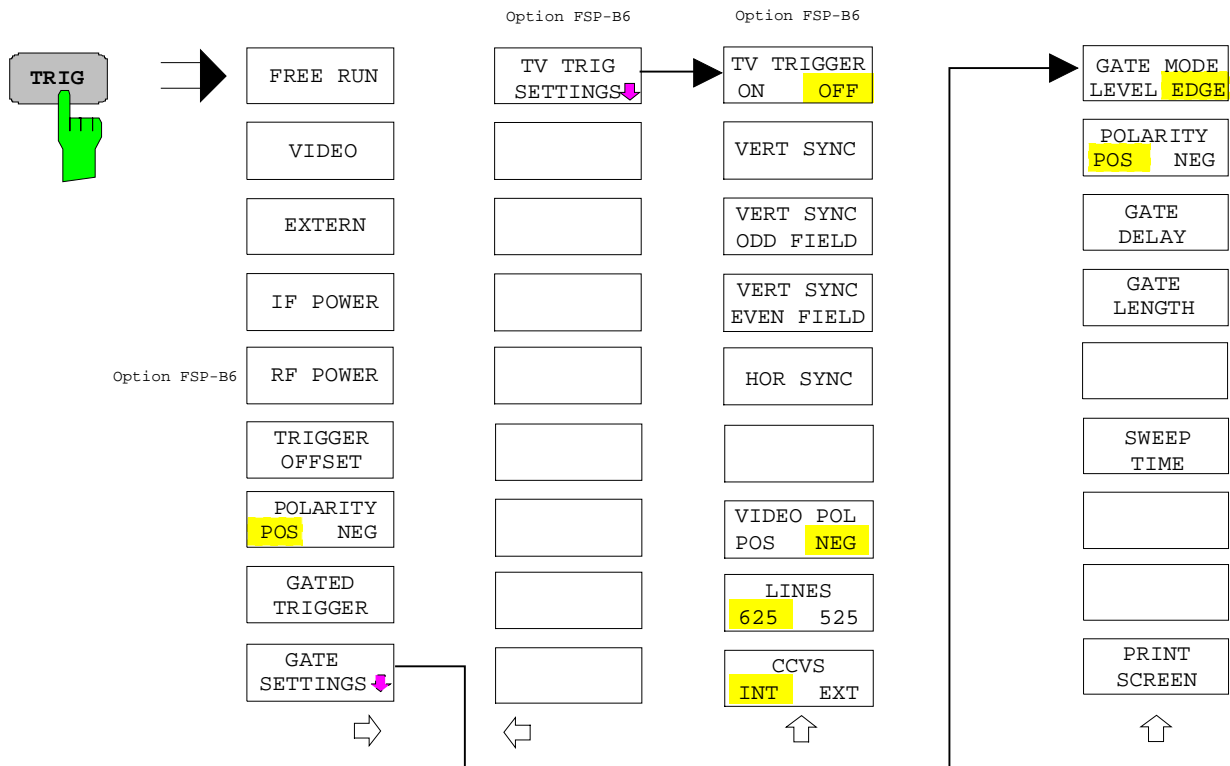

The *FREE RUN* softkey activates the free-run sweep mode, ie start of a sweep is not triggered. Once a measurement is completed, another is started immediately.

*FREE RUN* is the default setting of ESPI.

IEC/IEEE-bus command: TRIG:SOUR IMM

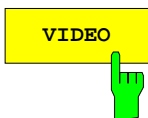

The *VIDEO* softkey activates triggering through the displayed voltage.

For the video triggering mode, a horizontal trigger line is shown in the diagram. It may be used to set the trigger threshold between 0% and 100% of the overall diagram height.

IEC/IEEE-bus command: TRIG:SOUR VID  
TRIG:LEV:VID 50 PCT



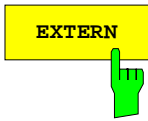

The *EXTERN* softkey activates triggering via a TTL signal at the input connector *EXT TRIGGER/GATE* on the rear panel.

IEC/IEEE-bus command:      TRIG:SOUR EXT  
    SWE:EGAT:SOUR EXT

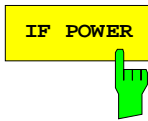

The *IF POWER* softkey activates triggering of the measurement via signals which are outside the measurement channel.

For this purpose, the ESPI uses a level detector at the second intermediate frequency. can be selected in a range between -30 dBm and -10 dBm at the input mixer. The resulting trigger level at the RF input is calculated via the following formula:

$$Mixerlevel_{min} + RFAtt - PreampGain \leq Input\ Signal \leq Mixerlevel_{max} + RFAtt - PreampGain$$

The bandwidth at the intermediate frequency is 10 MHz. The ESPI is triggered as soon as the trigger threshold is exceeded within a 5 MHz range around the selected frequency (= start frequency in the frequency sweep).. Thus, the measurement of spurious emissions, eg for pulsed carriers, is possible even when the carrier lies outside the selected frequency span.

IEC/IEEE-bus command:      TRIG:SOUR IFP  
    SWE:EGAT:SOUR IFP

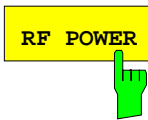

See following section Option FSP-B6 - TV- and RF-Trigger, page 4.90.

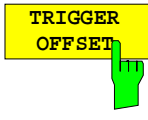

The *TRIGGER OFFSET* softkey activates the window for entering the time offset between the trigger signal and the start of the sweep.

Triggering is delayed by the entered time with respect to the trigger signal (time entered > 0) or is started earlier (time entered < 0). The time may be entered in multiples of 125 ns in the range -100 s to 100 s (default 0 s).

**Note:** A negative offset (pretrigger) can be set in the time domain only (SPAN = 0 Hz) provided GATED TRIGGER is not active in that domain.

The maximum allowed range and the maximum resolution of the pretrigger is limited by the set sweep time:

$$max.\ range = - 499/500 \times sweep\ time$$

$$max.\ resolution = sweep\ time/500.$$

Pretriggering is not possible when the rms or the average detector is activated

As a common input signal is used for both trigger and gate when selecting *EXTERN* and *IF POWER*, changes to the gate delay will affect the trigger delay (*TRIGGER OFFSET*) as well.

IEC/IEEE-bus command:      TRIG:HOLD 10US

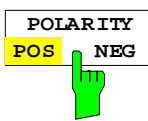

The *POLARITY POS/NEG* softkey selects the polarity of the trigger source.

The sweep starts after a positive or negative edge of the trigger signal. The selected setting is highlighted.

The selection is valid for all trigger modes with the exception of *FREE RUN*; in the gate mode, it also applies to the gate polarity.

The default setting is *POLARITY POS*.

IEC/IEEE-bus command:      TRIG:SLOP POS

By using a gate in sweep mode and stopping the measurement while the gate signal is inactive, the spectrum for pulsed RF carriers can be displayed without the superposition of frequency components generated during switching. Similarly, the spectrum can also be examined for an inactive carrier. The sweep can be controlled by an external gate or by the internal power trigger.

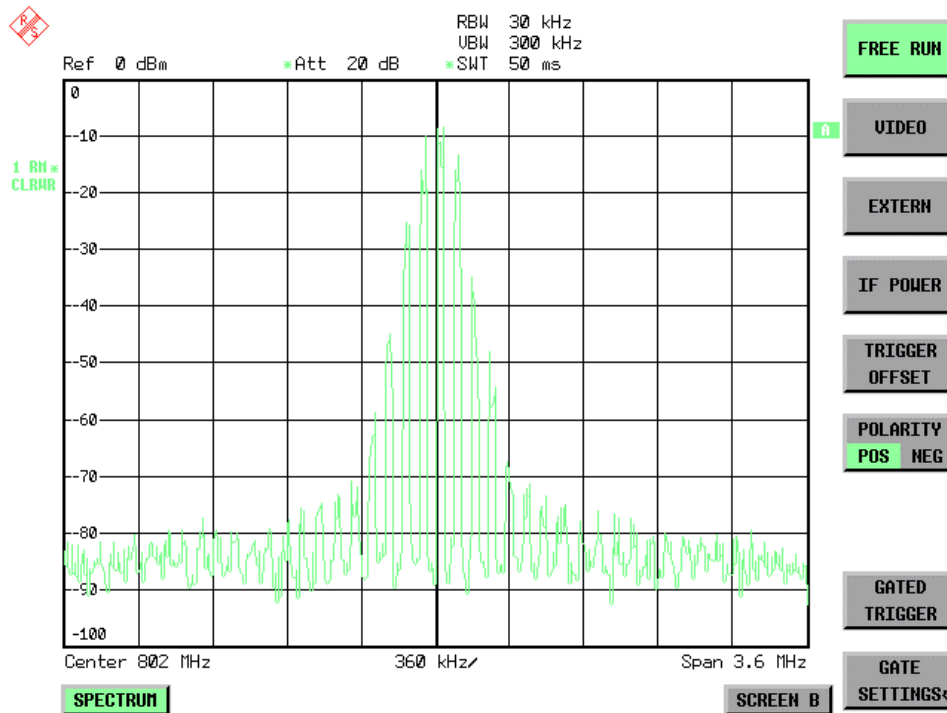

Fig. 4-8 Pulsed signal GATE OFF

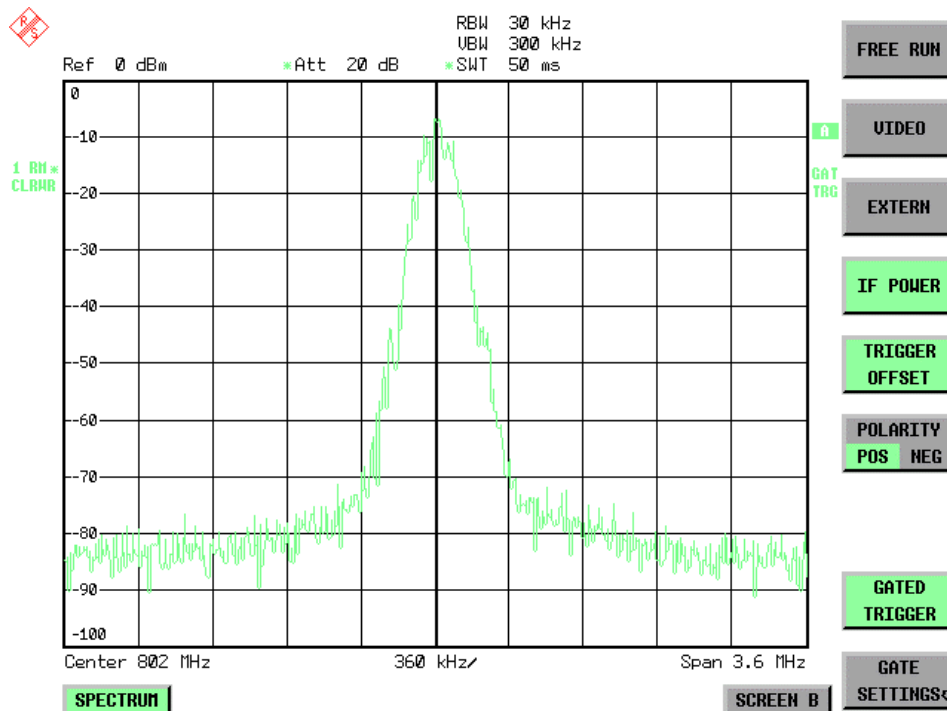
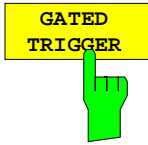

Fig. 4-9 TDMA signal with GATE ON

The gated-sweep mode is activated by the *GATED TRIGGER* softkey. The setting of the mode takes place in the *GATE SETTINGS* submenu.



The *GATED TRIGGER* softkey switches the sweep mode with gate on and off.

When gate is switched on, a gate signal applied to the rear panel connector *EXT TRIGGER/GATE* or the internal IF power detector controls the sweep of the analyzer. This selection is made via the *EXTERN* and *IF POWER* softkeys for trigger and gate.

The length of the gate signal defines when the sweep is to be interrupted. Here a differentiation is made between edge-triggered and level-triggered modes: in case of edge triggering the gate length can be set via the *GATE LENGTH* softkey, while in case of level triggering the gate length depends on the length of the gate signal.

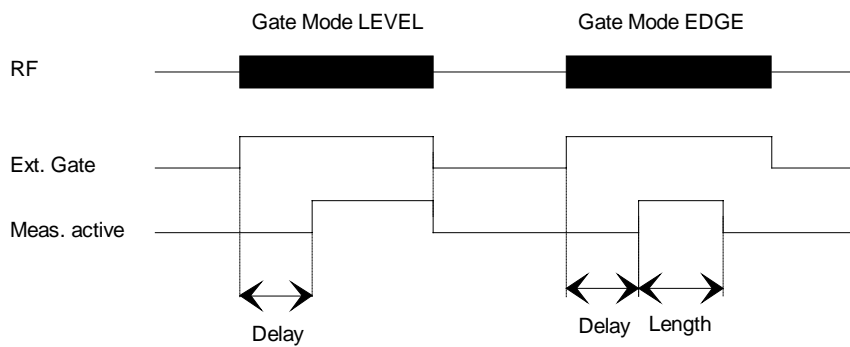

Fig.4-10 Timing diagram for GATE, GATE DELAY and GATE LENGTH

This softkey requires the *EXTERN* or *IF POWER* trigger mode. If a different mode is active, *IF POWER* is automatically selected.

Gated-sweep operation is also possible in the time domain. This enables - eg in burst signals - level variations of individual slots to be displayed versus time.

To indicate that a gate is used for the sweep, the enhancement label **GAT** is displayed on the screen. This label appears to the right of the window for which the gate is configured.

```
IEC/IEEE-bus command:  SWE:EGAT  ON
                        SWE:EGAT:SOUR  IFP
                        or :
                        SWE:EGAT:SOUR  EXT
```

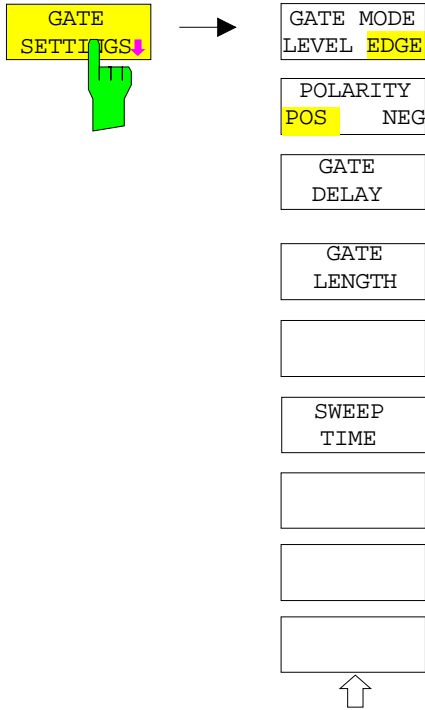

The *GATE SETTINGS* softkey calls a submenu for making all the settings required for gated-sweep operation.

At the same time, a transition is made to the time domain (span = 0) and the time parameters *GATE DELAY* and *GATE LENGTH* are represented as vertical lines. This allows the required gate time parameters to be set easily.

For highly accurate setting of gate delay and gate length, the x axis can be altered using the *ZOOM x-AXIS* softkey in a way that the signal range concerned (eg one full burst) is displayed.

Then the sampling time and duration can be set by *GATE DELAY* and *GATE LENGTH* in a way that the desired portion of the signal is shown.

When quitting the submenu, the program will return to the frequency domain provided it was active before. The original span is restored so the desired measurement can now be performed with the accurately set gate.

IEC/IEEE-bus command:        --

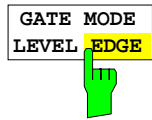

The *GATE MODE LEVEL/EDGE* softkey selects the trigger mode. Gated sweep is possible in the level-triggered as well as in the edge-triggered mode.

If level triggering is selected, the *GATE LENGTH* softkey becomes inactive and cannot be operated.

IEC/IEEE-bus command:        SWE:EGAT:TYPE  EDGE

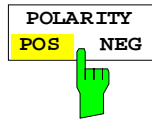

The *POLARITY POS/NEG* softkey controls the polarity of the *EXT TRIGGER/GATE* control line.

In case of level triggering the sweep is stopped by *POLARITY POS* and a logic '0' signal; the signal '1' will restart the sweep after the *GATE DELAY* time has elapsed.

In case of edge triggering the sweep is continued on a '0' to '1' transition for the duration of *GATE LENGTH* after a delay (*GATE DELAY*) has elapsed.

Changing the polarity automatically implies a transition of the trigger-edge polarity (*POLARITY* softkey in the higher menu).

IEC/IEEE-bus command:        SWE:EGAT:POL  POS

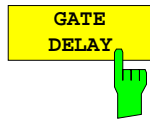

The *GATE DELAY* softkey activates the window for setting the delay time between the gate signal and the continuation of the sweep.

This may be useful for taking into account a delay between the gate signal and the stabilization of an RF carrier for example.

As gate delay, values between 125 ns and 100 s may be set. The position of the delay on the time axis in relation to the sweep is indicated by the line labelled **GD**.

As there is a common input signal for trigger and gate if *EXTERN* or *IF POWER* is selected, changes to the gate delay will affect the trigger delay (*TRIGGER OFFSET*) as well.

IEC/IEEE-bus command:       SWE:EGAT:HOLD 1US

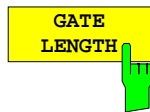

The *GATE LENGTH* softkey activates the window for setting the sweep duration of ESPI in the edge-triggered mode.

Values between 125 ns and 100 s may be set for the gate length. The length of the gate in relation to the sweep is indicated by the line labelled **GL**.

This softkey is only available if *GATE MODE EDGE* (edge triggering) has been selected.

IEC/IEEE-bus command:       SWE:EGAT:LENG 100US



The *SWEEP TIME* softkey enables the user to change the time axis to obtain a higher resolution for positioning gate delay and gate length.

When this is to be done, the sweep time temporarily changes; the original value is restored when the menu is quit.

IEC/IEEE-bus command:       --

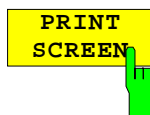

The *PRINT SCREEN* starts the printout of the gate settings.

IEC/IEEE-bus command:       --

**Measurement example:**

The modulation spectrum of a GSM or PCS1900 signal is to be measured using the gated-sweep function. The signal is generated by a Signal Generator SME03 whose RF output is directly connected to the RF input of ESPI.

**Settings on SME03:**

FREQ:                   802 MHz  
 Level:                 0 dBm: Return  
 Digital Mod:         Select: GMSK: Select  
 Source:               Select: PRBS: Select: Return  
 Level Attenuation:   Select: 60 dB: Return

The SME03 supplies a GMSK-modulated TDMA signal (GSM).

Settings on ESPI:

Conventions:     **[KEY]**       Menu called by this key. All information between the brackets refers to this menu.  
                   {Number}    Numeric value to be entered for the parameter on hand.  
                   SOFTKEY    Softkey to be used for making a selection or entering a value.

**[PRESET]**  
**[FREQ:**            *CENTER {802} MHz]*  
**[SPAN**             *{3.6} MHz]*  
**[AMPT:**            *REF LEVEL {0} dBm: RF ATTEN MANUAL: {10} dB]*  
**[BW:**              *RES BW MANUAL: {30} kHz]*  
**[TRACE :**          *TRACE 1        DETECTOR: RMS]*  
**[SWEEP:**          *SWEEPTIME MANUAL: {50} ms]*  
**[TRIG:**            *EXTERN*  
                       *GATED TRIGGER;*  
                       *GATE SETTINGS: GATE MODE EDGE; POLARITY POS*  
                       *SWEEPTIME MANUAL {1} ms: GATE DELAY {300} μs;*  
                       *GATE LENGTH: {250} μs]*

The following figure shows the screen display for setting gate parameters. The vertical lines for gate delay (GD) and gate length (GL) can be adjusted to the burst signal by entering numeric values or by means of the rollkey.

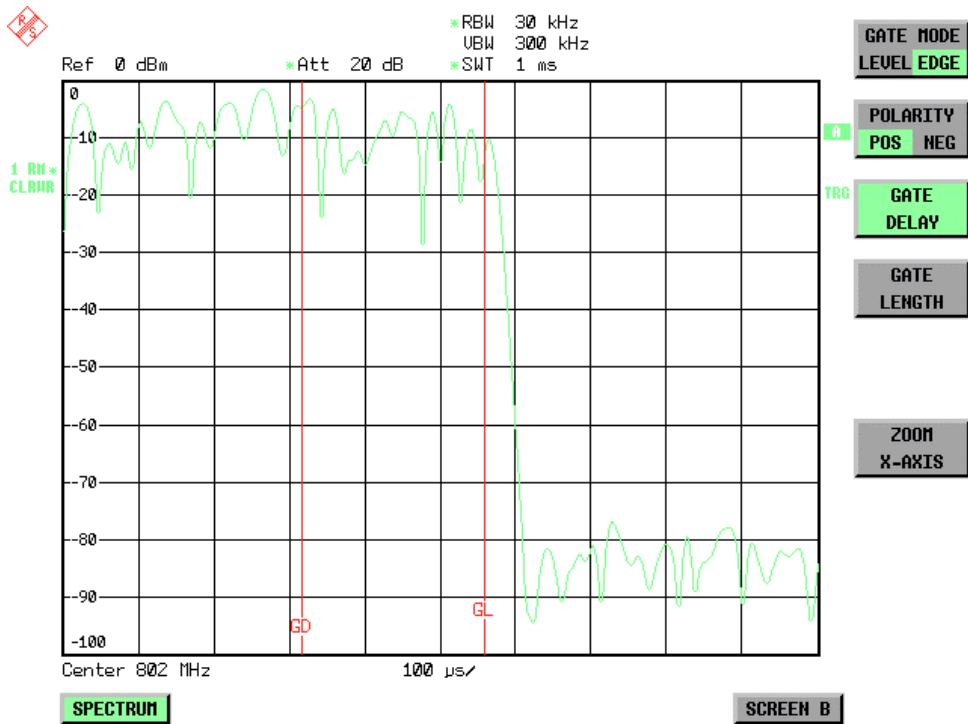

Fig.4-11     Setting GATE DELAY and GATE LENGTH in time domain by means of lines GD and GL

On quitting the *GATE SETTINGS* menu, ESPI returns to the previous screen.

### Option FSP-B6 - TV- and RF-Trigger

Option TV- and RF-Trigger, FSP-B6, supplies the ESPI with the capability of triggering on TV signals or on the presence of a RF carrier outside the resolution bandwidth.

For this purpose the hardware board is equipped with a TV demodulator, which produces the trigger signals necessary for analysis of TV signals. In addition to the pure trigger function the board also creates a demodulated CCVS video signal for operation of external TV monitors. Apart from using the internal IF for creating the trigger signals the ESPI can also make use of an externally supplied CCVS signal; the corresponding connector is placed at the rear panel of the instrument.

In order to display different sections of a TV video signal, the ESPI derives several trigger signals from the video signals. This allows triggering as well on the frame repetition as on each line of the TV video signal.

Additionally the option includes a broadband RF detector (bandwidth = 80 MHz), which allows triggering within a 40 MHz range around the selected frequency (= start frequency in the frequency sweep). Thus, the measurement of spurious emissions, eg for pulsed carriers, is possible even when the carrier lies outside the selected frequency span. This RF power trigger can be used as long as the RF signal at the input mixer is in the range of -10 dBm to -50 dBm. The resulting range for the input signal at the RF input connector can be calculated using the following formula:

$$Mixerlevel_{min} + RFAtt - PreampGain \leq Input\ Signal \leq Mixerlevel_{max} + RFAtt - PreampGain$$

The RF Power Trigger can be selected and configured in the trigger menu (TRIG):

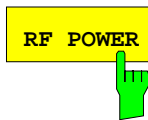

The *RF POWER* softkey activates triggering of the measurement via signals which are outside the measurement channel.

For this purpose the instrument uses a level detector at the first intermediate frequency. The detector threshold can be selected in a range between -50 dBm and -10 dBm at the input mixer. The resulting trigger level at the RF input is calculated via the following formula:

$$Mixerlevel_{min} + RFAtt - PreampGain \leq Input\ Signal \leq Mixerlevel_{max} + RFAtt - PreampGain$$

The bandwidth at the intermediate frequency is 80 MHz. The instrument is triggered as soon as the trigger threshold is exceeded within a 40 MHz range around the selected frequency (= start frequency in the frequency sweep). Thus, the measurement of spurious emissions, eg for pulsed carriers, is possible even when the carrier lies outside the selected frequency span.

IEC/IEEE-bus command:      TRIG:SOUR RFP  
    SWE:EGAT:SOUR RFP

The configuration menu for TV trigger settings can be reached with key sequence *TRIG - NEXT - TV TRIG SETTINGS*:



The *TV TRIG SETTINGS* softkey switches the TV trigger on and opens a submenu for configuration of the TV signal parameters.

**Note:** *Triggering on TV signals is only possible in time domain (span = 0 Hz). Therefore the softkey TV TRIG SETTINGS is without function in frequency domain.*

IEC/IEEE-bus command:      TRIG:SOUR TV

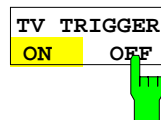

The *TV TRIGGER ON/OFF* softkey switches the TV Trigger on or off. When switching off the TV trigger the selected trigger source will be *FREE RUN*.

IEC/IEEE-bus command:      SENS:TV ON | OFF

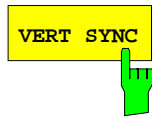

The *VERT SYNC* softkey configures the trigger for the vertical sync signal. The ESPI triggers on the frame repetition without distinction between the two fields.

IEC/IEEE-bus command: `TRIG:VID:FIEL:SEL ALL`



The softkeys *VERT SYNC ODD FIELD* and *VERT SYNC EVEN FIELD* configure the trigger for the vertical sync signal of the first or second field.



IEC/IEEE-bus command:  
`TRIG:VID:FIEL:SEL EVEN | ODD`

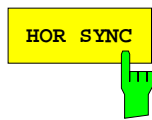

The *HOR SYNC* softkey configures the trigger for the horizontal sync signal and opens the data entry field for selection of the corresponding line.

The trigger can be set on any line number, which can be in the range of 1 to 525 or 1 to 625, depending on the line system. The maximum possible line number will be selected if the active range is exceeded.

In order to trigger on test line 17 according to CCIR 473-4, for example, the line value has to be set to 17. This is the default setting after switching on the TV trigger.

IEC/IEEE-bus command: `TRIG:VID:LINE:NUM 17`

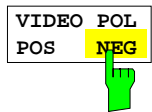

The *VIDEO POL POS / NEG* softkey selects the polarity of the video signal.

Positive video polarity is to be selected e.g. for standard L signals, negative video polarity for signals according to the standards B/G/I/M (color standard PAL or NTSC). Default setting is *VIDEO POL NEG*.

IEC/IEEE-bus command: `TRIG:VID:SSIG:POL NEG`

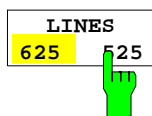

The *LINES 625 / 525* softkey selects the line system currently in use.

Default setting is *625 LINES*.

IEC/IEEE-bus command: `TRIG:VID:FORM:LPFR 625`

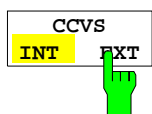

The *CCVS INT / EXT* softkey selects the input channel for the TV trigger input signal. An external CCVS signal can be supplied via the corresponding connector at the rear panel of the instrument.

IEC/IEEE-bus command: `SENS:TV:CCVS INT`



## Selection and Setting of Traces – TRACE Key

The ESPI is capable of displaying up to three different traces at a time in a diagram. A trace consists of a maximum of 501 pixels on the horizontal axis (frequency or time). If more measured values than pixels are available, several measured values are combined in one pixel.

The traces can individually be activated for a measurement or frozen after completion of a measurement. Traces that are not activated are blanked.

The display mode can be selected for each trace. Traces can be overwritten in each measurement (CLEAR/WRITE mode), averaged over several measurements (AVERAGE mode), or a maximum or minimum value can be determined from several measurements and displayed (MAX HOLD or MIN HOLD).

Individual detectors can be selected for the various traces. The autopeak detector displays maximum and minimum values connected by a vertical line. The max peak detector and min peak detector display the maximum and minimum value of the level within a pixel. The sample detector displays the instantaneous value of the level at a pixel. The rms detector displays the power (rms value) of the measured values within a pixel, the average detector the average value.

### Selection of Trace Function

The trace functions are subdivided as follows:

- Display mode of trace (CLEAR/WRITE, VIEW and BLANK)
- Evaluation of the trace as a whole (AVERAGE, MAX HOLD and MIN HOLD)
- Evaluation of individual pixels of a trace (AUTOPEAK, MAX PEAK, MIN PEAK, SAMPLE, RMS, AVERAGE and QUASIPEAK)

TRACE menu

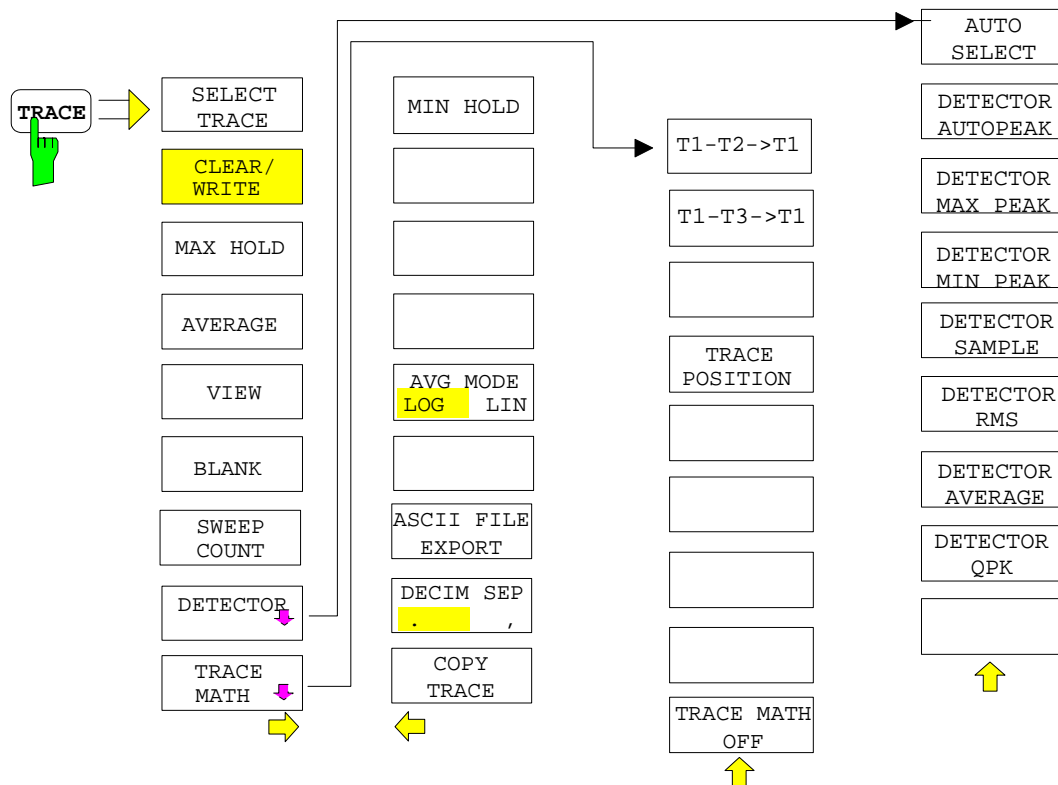

The *TRACE* key opens a menu offering the setting options for the selected trace.

In this menu, the mode of representing the measured data in the frequency or time domain in the 501 pixels of the display is determined. Upon start of the measurement, each trace can be displayed either completely new or based on the previous results.

In this menu, the mode of representing the measured data in the frequency or time domain in the 501 pixels of the display is determined. Upon start of the measurement, each trace can be displayed either completely new or based on the previous results. Traces can be displayed, blanked and copied. Traces can also be corrected with the aid of mathematical functions.

The measurement detector for the individual display modes can be selected directly by the user or set automatically by ESPI.

The default setting is trace 1 in the overwrite mode (*CLEAR / WRITE*), the other traces 2 and 3 are switched off (*BLANK*).

The *CLEAR/WRITE*, *MAX HOLD*, *MIN HOLD*, *AVERAGE*, *VIEW* and *BLANK* softkeys are mutually exclusive selection keys.



The *SELECT TRACE* softkey activates the entry for the active trace (1, 2, 3).

IEC/IEEE-bus command -- (selected via numeric suffix of :TRACe)



The *CLEAR/WRITE* softkey activates the overwrite mode for the collected measured values, ie the trace is overwritten by each sweep.

In the *CLEAR/WRITE* display mode all the available detectors can be selected. In the default mode the autopeak detector (setting *AUTO*) is selected.

Each time the *CLEAR/WRITE* softkey is actuated, ESPI clears the selected trace memory and starts the measurement anew.

IEC/IEEE-bus command          DISP:WIND:TRAC:MODE WRIT

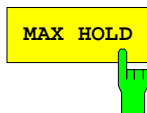

The *MAX HOLD* softkey activates the max peak detector.

ESPI saves the sweep result in the trace memory only if the new value is greater than the previous one.

The detector is automatically set to *MAX PEAK*. The maximum value of a signal can thus be determined over several sweeps.

This is especially useful with modulated or impulsive signals. The signal spectrum is filled up upon each sweep until all signal components are detected in a kind of envelope.

Pressing the *MAX HOLD* softkey again clears the trace memory and restarts the max hold mode.

IEC/IEEE-bus command          DISP:WIND:TRAC:MODE MAXH

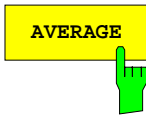

The *AVERAGE* softkey activates the trace averaging function. The average is formed over several sweeps. Averaging can be performed with any of the detectors available. If the detector is automatically selected by ESPI, the sample detector is used.

Depending on the setting of AVG MODE LOG / LIN, the logarithmic level values or the measured power/voltage values are averaged.

Averaging is restarted every time the *AVERAGE* softkey is pressed. The trace memory is always cleared.

IEC/IEEE-bus command      DISP:WIND:TRAC:MODE AVER

### Description of averaging

Averaging is carried out over the pixels derived from the measurement samples. Several measured values may be combined in a pixel. This means that with linear level display the average is formed over linear amplitude values and with logarithmic level display over levels. For this reason the trace must be measured again when changing between *LIN* and *LOG* display mode. The settings *CONT/SINGLE SWEEP* and running averaging apply to the average display analogously.

There are two methods for calculating the average. For a sweep count = 0, a running average is calculated according to the following formula:

$$\text{TRACE} = \frac{9 * \text{TRACE} + \text{meas. value}}{10}$$

Due to the weighting between the new measured value and the trace average, past values have practically no influence on the displayed trace after about ten sweeps. With this setting, signal noise is effectively reduced without need for restarting the averaging process after a change of the signal.

If the sweep count is >1, averaging takes place over the selected number of sweeps. In this case the displayed trace is determined during averaging according to the following formula:

$$\text{Trace}_n = \frac{1}{n} \left| \sum_{i=1}^{n-1} (T_i) + \text{meas. value}_n \right|$$

where *n* is the number of the current sweep (*n* = 2 ... SWEEP COUNT). No averaging is carried out for the first sweep but the measured value is stored in the trace memory. With increasing *n*, the displayed trace is increasingly smoothed since there are more single sweeps for averaging.

After the selected number of sweeps the average trace is saved in the trace memory. Until this number of sweeps is reached, a preliminary average is displayed.

After completion of averaging, ie when the averaging length defined by *SWEEP COUNT* is attained, a running averaging is continued with *CONTINUOUS SWEEP* according to the following formula:

$$\text{Trace} = \frac{(N-1) \cdot \text{Trace}_{\text{old}} + \text{meas. value}}{N} \quad \text{where} \quad \begin{array}{l} \text{Trace} = \text{new trace} \\ \text{Trace}_{\text{old}} = \text{old trace} \\ N = \text{SWEEP COUNT} \end{array}$$

The display "Sweep N of N" does not change any more until a new start is triggered.

In the *SINGLE SWEEP* mode, the number of sweeps is triggered with *SWEEP START*. The sweeps are stopped when the selected number of sweeps is attained. The number of the current sweep and the total number of sweeps are shown on the display: "Sweep 3 of 200".

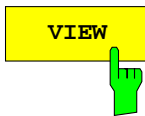

The *VIEW* softkey freezes the current contents of the trace memory and displays it.

If a trace is frozen by *VIEW*, the instrument settings can be changed without the displayed trace being modified (exception: level display range and reference level, see below). The fact that the trace and the current instrument setting do not agree any more is indicated by an enhancement label "\*" at the right edge of the grid.

If in the *VIEW* display mode the level display range (*RANGE*) or the reference level (*REF LEVEL*) are changed, ESPI automatically adapts the measured data to the changed display range. This allows an amplitude zoom to be made after the measurement in order to show details of the trace.

IEC/IEEE-bus command      `DISP:WIND:TRAC:MODE VIEW`

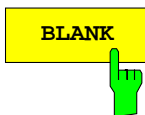

The *BLANK* softkey activates the blanking of the trace on the screen.

IEC/IEEE-bus command      `DISP:WIND:TRAC OFF`



The *SWEEP COUNT* softkey activates the entry of the number of sweeps used for averaging. The allowed range of values is 0 to 30000 and the following should be observed:

- Sweep Count = 0 means running averaging
- Sweep Count = 1 means no averaging being carried out
- Sweep Count > 1 means averaging over the selected number of sweeps; in the continuous sweep mode averaging is performed until the set number of sweeps is attained and is then continued as running averaging.

The default setting is running averaging (Sweep Count = 0). The number of sweeps used for averaging is the same for all active traces in the selected diagram.

**Note:**      *The setting of the sweep count in the trace menu is equivalent to the setting in the sweep menu.*

IEC/IEEE-bus command      `SWE:COUN 64`



See following Section "Selection of Detector"



See following Section "Mathematical Functions for Traces"

## TRACE - NEXT menu

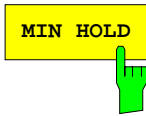

The *MIN HOLD* softkey activates the min peak detector. ESPI saves for each sweep the smallest of the previously stored/currently measured values in the trace memory. The detector is automatically set to *MIN PEAK*. In this way, the minimum value of a signal can be determined over several sweeps.

This function is useful eg for making an unmodulated carrier in a composite signal visible. Noise, interference signals or modulated signals are suppressed by the min hold function whereas a CW signal is recognized by its constant level.

Pressing the *MIN HOLD* softkey again clears the trace memory and restarts the min hold function.

IEC/IEEE-bus command      `DISP:WIND:TRAC:MODE MINH`



The *AVG MODE LOG/LIN* softkey selects logarithmic or linear averaging for the logarithmic level display mode.

At the same time the difference calculation is switched between linear and logarithmic in submenu *TRACE MATH*.

IEC/IEEE-bus command      `CALC:MATH:AVER:MODE LIN`

With logarithmic averaging, the dB values of the display voltage are averaged or subtracted from each other with trace mathematical functions. With linear averaging the level values in dB are converted into linear voltages or powers prior to averaging. Voltage or power values are averaged or offset against each other and reconverted into level values.

For stationary signals the two methods yield the same result.

Logarithmic averaging or difference calculation is recommended if sinewave signals are to be clearly visible against noise since with this type of averaging noise suppression is improved while the sinewave signals remain unchanged.

For noise or pseudo-noise signals the positive peak amplitudes are decreased in logarithmic averaging due the characteristic involved and the negative peak values are increased relative to the average value. If the distorted amplitude distribution is averaged, a value is obtained that is smaller than the actual average value. The difference is -2.5 dB.

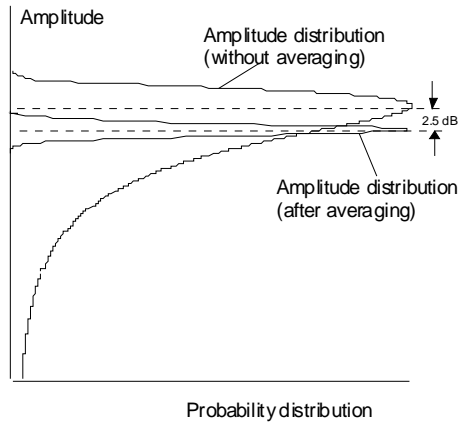

This low average value is usually corrected in noise power measurements by a 2.5 dB factor. Therefore the ESPI offers the selection of linear averaging. The trace data are delogarithmized prior to averaging, then averaged and logarithmized again for display on the screen. The average value is always correctly displayed irrespective of the signal characteristic.

ASCII FILE  
EXPORT



The *ASCII FILE EXPORT* softkey stores the active trace in ASCII format on a floppy disk.

```
IEC/IEEE command  FORM ASC;
                   MMEM:STOR:TRAC 1, 'TRACE.DAT'
```

The file consists of the header containing important scaling parameters and a data section containing the trace data.

The data of the file header consist of three columns, each separated by a semicolon:

parameter name; numeric value; basic unit

The data section starts with the keyword " Trace <n> " (<n> = number of stored trace), followed by the measured data in one or several columns (depending on measurement) which are also separated by a semicolon.

This format can be read in from spreadsheet calculation programs, eg MS-Excel. It is necessary to define ';' as a separator.

**Note:** *Different language versions of evaluation programs may require a different handling of the decimal point. It is therefore possible to select between separators '.' (decimal point) and ',' (comma) using softkey DECIM SEP.*

Example:

	File contents	Description
<b>File header</b>	Type;ESPI3;	Instrument model
	Version;1.00;	Firmware version
	Date;01.Jul 1999;	Date of data set storage
	Mode;Spectrum;	Instrument mode
	Center Freq;55000;Hz	Center frequency
	Freq Offset;0;Hz	Frequency offset
	Span;90000;Hz	Frequency range (0 Hz with zero span and statistics measurements)
	x-Axis;LIN;	Scaling of x axis linear (LIN) or logarithmic (LOG)
	Start;10000;Hz	Start/stop of the display range.
	Stop;100000;Hz	Unit: Hz for span > 0, s for span = 0, dBm/dB for statistics measurements
	Ref.Level;-30;dBm	Reference level
	Level Offset;0;dB	Level offset
	Ref Position;75;%	Position of reference level referred to diagram limits (0% = lower edge)
	y-Axis;LOG;	Scaling of y axis linear (LIN) or logarithmic (LOG)
	Level Range;100;dB	Display range in in y direction. Unit: dB with x axis LOG, % with x axis LIN
	RF Att;20;dB	Input attenuation
	RBW;100000;Hz	Resolution bandwidth
VBW;30000;Hz	Video bandwidth	
SWT;0.005;s	Sweep time	
Trace Mode;AVERAGE;	Display mode of trace: CLR/WRITE,AVERAGE,MAXHOLD,MINHOLD	
Detector;SAMPLE;	Detector set: AUTOPEAK,MAXPEAK,MINPEAK,AVERAGE, RMS,SAMPLE,QUASISPEAK	
Sweep Count;20;	Number of sweeps set	
<b>Data section of the file</b>	Trace 1;;;	Selected trace
	x-Unit;Hz;	Unit of x values: Hz with span > 0; s with span = 0; dBm/dB with statistics measurements
	y-Unit;dBm;	Unit of y values: dB*/V/A/W depending on the selected unit with y axis LOG or % with y axis LIN
	Values;501;	Number of test points
	10000;-10.3;-15.7	Measured values: <x value>, <y1>, <y2>
	10180;-11.5;-16.9	<y2> being available only with detector AUTOPEAK and containing in this case the smallest of the two measured values for a test point.
10360;-12.0;-17.4		
...;...;		

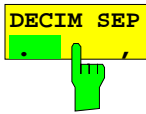

The *DECIM SEP* softkey selects the decimal separator between '.' (decimal point) and ',' (comma) with floating-point numerals for the function ASCII FILE EXPORT.

With the selection of the decimal separator different language versions of evaluation programs (eg MS-Excel) can be supported.

IEC/IEEE-bus command `FORM:DEXP:DSEP POIN`

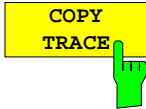

The *COPY TRACE* softkey copies the screen contents of the current trace into another trace memory. The desired memory is selected by entering the number 1, 2 or 3.

Upon copying, the contents of the selected memory is overwritten and the new contents displayed in view mode.

IEC/IEEE-bus command `TRAC:COPY TRACE1,TRACE2`



## Selection of Detector

The detectors of the ESPI are implemented as pure digital devices. The detectors available are the peak detectors which determine the maximum and/or the minimum value from a number of samples, the rms detector which measures the power within a pixel, the average, the quasipeak and the sample detector. The sample detector routes through the sampled data without any modification or performs a data reduction by suppressing measured values that cannot be displayed.

The peak detectors compare the current level value with the maximum or minimum level from the previously sampled data. When the number of samples defined by the instrument setting is reached, the samples are combined in displayable pixels. Each of the 501 pixels of the display thus represents 1/501 of the sweep range and contains all single measurements (frequency samples) in this subrange in compressed form. For each trace display mode an optimized detector is selected automatically. Since peak detectors and sample detector are connected in parallel, a single sweep is sufficient for collecting all detector values for 3 traces.

Peak detectors  
(*MAX PEAK* and *MIN PEAK*)

Peak detectors are implemented by digital comparators. They determine the largest of all positive (max peak) or the smallest of all negative (min peak) peak values of the levels measured at the individual frequencies which are displayed in one of the 501 pixels. This procedure is repeated for each pixel so that for wide frequency spans and despite the limited resolution of the display a large number of measurements can be taken into consideration for the display of the spectrum.

Autoppeak detector

The *AUTOPEAK* detector combines the two peak detectors. The max peak detector and the min peak detector simultaneously determine the maximum and the minimum level within a displayed testpoint and display it as a single measured value. The maximum and minimum levels within a frequency point are connected by a vertical line.

Sample detector

The *SAMPLE* detector routes through the sampled data without any further evaluation and either displays them directly or, for reasons of speed in case of short sweep times, first writes them into a memory and processes them subsequently.

There is no data reduction, ie no summing up of measured values of neighbouring frequencies or time samples. If during a frequency sweep more measured values are obtained than can be displayed, measured values will be lost. This means that discrete signals might be lost.

The sample detector therefore can only be recommended for a span-to-resolution bandwidth ratio of up to approx. 250 in order to ensure that no signal will be suppressed (example: span 1 MHz, - > min. bandwidth 5 kHz).

RMS detector	<p>The RMS detector forms the rms value of the measured values within a pixel.</p> <p>To this effect, ESPI uses the linear voltage after envelope detection. The sampled linear values are squared, summed and the sum is divided by the number of samples (= root mean square). For logarithmic display the logarithm is formed from the square sum. For linear display the root mean square value is displayed. Each pixel thus corresponds to the power of the measured values summed up in the pixel.</p> <p>The rms detector supplies the power of the signal irrespective of the waveform (CW carrier, modulated carrier, white noise or impulsive signal). Correction factors as needed for other detectors for measuring the power of the different signal classes are not required.</p>
Average detector	<p>The average detector forms the average value of the measured values within a pixel.</p> <p>To this effect, ESPI uses the linear voltage after envelope detection. The sampled linear values are summed up and the sum is divided by the number of samples (= linear average value). For logarithmic display the logarithm is formed from the average value. For linear display the average value is displayed. Each pixel thus corresponds to the average of the measured values summed up in the pixel.</p> <p>The average detector supplies the average value of the signal irrespective of the waveform (CW carrier, modulated carrier, white noise or impulsive signal).</p>
Quasipeak detector	<p>The quasipeak detector simulates the behaviour of an analog voltmeter by evaluating the measured values in a pixel.</p> <p>The quasipeak detector is especially designed for the requirements of EMC measurements and is used for evaluating pulse-shaped spurious.</p>

**Note:** *During a frequency sweep, ESPI increments the 1st local oscillator in steps that are smaller than approximately 1/10 of the bandwidth. This is to ensure that the signal level is correctly measured. For narrow bandwidths and wide frequency spans a very large number of measured values is thus obtained. The number of frequency steps, however, always is a multiple of 501 (= number of pixels that can be displayed). With the sample detector selected, only every  $n^{\text{th}}$  value is displayed. The value of  $n$  depends on the number of measured values, ie on the frequency span, the resolution bandwidth and the measurement rate.*

TRACE-DETECTOR submenu

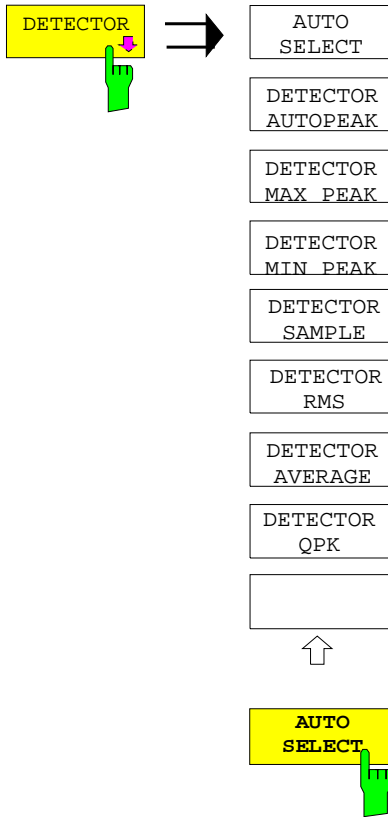

The *DETECTOR* softkey opens a submenu for selecting the detector for the selected trace. The softkey is highlighted if the detector is not selected with *AUTO SELECT*.

The detector can be selected independently for each trace. The *AUTO SELECT* mode selects the optimum detector for each display mode of the trace (Clear/Write, Max Hold or Min Hold).

The softkeys for the detectors are mutually exclusive selection keys.

The *AUTO SELECT* softkey (= default setting) selects the optimum detector for the set display mode of the trace (Clear/Write, Max Hold and Min Hold) and the selected filter mode (bandpass/FFT).

Trace display	Detector (bandpass)	Detector (FFT)
Clear/Write	Auto Peak	Max Peak
Average	Sample	Sample
Max Hold	Max Peak	Max Peak
Min Hold	Min Peak	Max Peak

The detector activated for the specific trace is identified in the respective trace display field as follows:

Detector	
Auto Peak	AP
Max Peak	PK
Min Peak	MI
Average	AV
RMS	RM
Sample	SA
Quasipeak	QP

IEC/IEEE-bus command      DET:AUTO ON

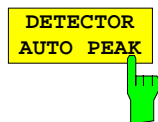

The *DETECTOR AUTOPEAK* softkey activates the autopeak detector.

IEC/IEEE-bus command      DET APE

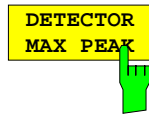

The *DETECTOR MAX PEAK* softkey activates the max peak detector. It is recommended for measurement of impulsive signals.

IEC/IEEE-bus command      DET POS

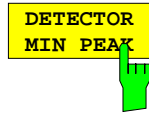

The *DETECTOR MIN PEAK* softkey activates the min peak detector. Weak sinewave signals become clearly visible in noise using this detector. In case of a composite signal made up of sinewave and impulsive signals, the impulsive signals are suppressed.

IEC/IEEE-bus command      DET NEG

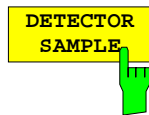

The *DETECTOR SAMPLE* softkey activates the sample detector.

It is used for measuring uncorrelated signals such as noise. The power can be determined with the aid of fixed correction factors for evaluation and the logarithmic function.

IEC/IEEE-bus command      DET SAMP

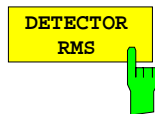

The *DETECTOR RMS* softkey activates the rms detector.

The rms detector supplies the power of the signal independent of the waveform. For this effect the root mean square of all sampled level values is formed during the sweep of a pixel. The sweep time thus determines the number of averaged values and with increasing sweep time better averaging is obtained. The rms detector is thus an alternative for averaging over several sweeps (see TRACE AVERAGE).

Since the video bandwidth must be at least 10 times the resolution bandwidth (RBW) to ensure that video filtering does not invalidate the rms values of the signal, this ratio is set automatically upon activating the detector.

IEC/IEEE-bus command      DET RMS

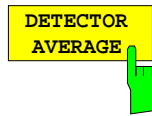

The *DETECTOR AVERAGE* softkey activates the average detector.

In contrast to the rms detector, the average detector supplies the linear average of all sampled level values during the sweep of a pixel.

The same relations as for the rms detector apply (see above).

IEC/IEEE-bus command      DET AVER

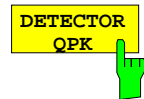

The *DETECTOR QPK* softkey activates the quasipeak detector.

This detector evaluates the sampled level values during the sweep of a pixel like an analog voltmeter.

On switching the quasipeak detector on the video bandwidth is automatically set to 10 MHz so as to exclude the influence of the video filter on the signal evaluation.

IEC/IEEE-bus command      DET QPE

## Mathematical Functions for Traces

TRACE 1-TRACE MATH submenu:

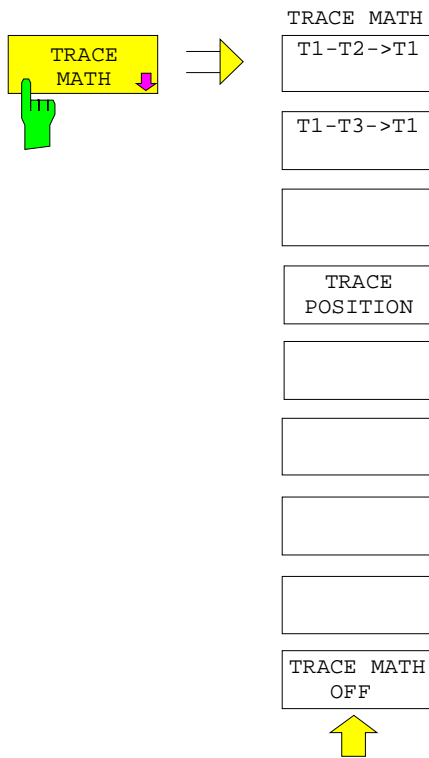

The *TRACE MATH* softkey opens a submenu in which the difference between the selected trace to trace 1 is calculated. The softkey is highlighted if a math function is activated.

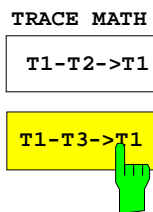

The *T1-T2* and *T1-T3* softkeys subtract the corresponding traces. The result displayed is referred to the zero point defined by *TRACE POSITION*.

To indicate that the trace has been obtained by subtraction, the difference "1 - 2" or "1 - 3" is indicated on the trace info of trace 1 and in the *TRACE* main menu the *TRACE MATH* softkey is highlighted.

IEC/IEEE-bus command `CALC:MATH (TRACE1-TRACE2)`  
`CALC:MATH (TRACE1-TRACE3)`



The *TRACE POSITION* softkey activates the entry of the trace position for 0 difference. The position is stated in % of the diagram height.

The range of values extends from -100% to +200%

IEC/IEEE-bus command `DISP:MATH:POS 50PCT`

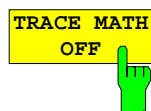

The *TRACE MATH OFF* softkey switches the math function off.

IEC/IEEE-bus command `CALC:MATH:STAT OFF`

## Recording the Correction Data of ESPI – CAL Key

The ESPI obtains its high measurement accuracy through its inbuilt self-alignment method.

The correction data and characteristics required for the alignment are determined by comparison of the results at different settings with the known characteristics of the high-precision calibration signal source of ESPI at 128 MHz. The correction data are then available in the instrument as a file and can be displayed by means of the *CAL RESULTS* softkey.

For service purposes the use of correction data can be deactivated by means of the *CAL CORR ON/OFF* softkey. If the correction data recording is aborted, the last complete correction data set is restored.

**Note:** *The term "Calibration" formerly used for the integrated self alignment was often mistaken for the "true" calibration of the instrument at the test set in production and in service. It is therefore no longer used although it appears in the abbreviated form in the name of keys ("CAL...").*

CAL menu:

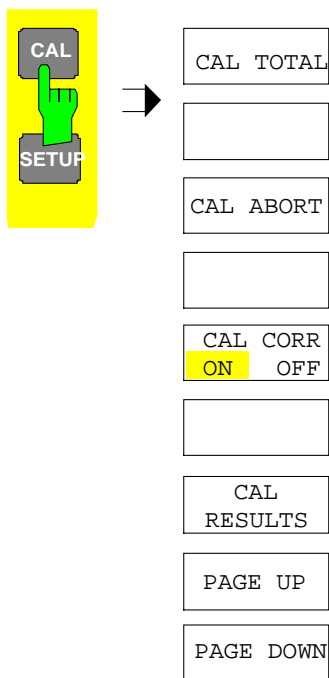

The *CAL* key opens a menu with the available functions for recording, displaying and activating the data for self alignment.



The *CAL TOTAL* softkey starts the recording of correction data of the instrument.

If the correction data recording has failed or if the correction values are deactivated (*CAL CORR = OFF* softkey), the status field indicates

**UNCAL.**

IEC/IEEE-bus command: \*CAL?



The *CAL ABORT* softkey interrupts the recording of correction data and restores the last complete correction data set.

IEC/IEEE-bus command: CAL:ABOR

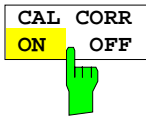

The *CAL CORR ON/OFF* softkey switches the calibration data on/off.

ON The status message depends upon the results of the total calibration.

OFF The message *UNCAL* appears in the status line.

IEC/IEEE-bus command: CAL:STAT ON



The *CAL RESULTS* softkey calls the *CALIBRATION RESULTS* table, which shows the correction data found during calibration.

The *CALIBRATION RESULTS* table contains the following information:

- date and time of last record of correction values
- overall results of correction value record
- list of found correction values according to function/module

The results have the following meaning:

PASSED calibration successful without any restrictions

CHECK deviation of correction value larger than expected, correction could however be performed

FAILED deviations of correction value too large, no correction was possible. The found correction data are not valid.

ABORTED calibration aborted

CALIBRATION RESULTS				
Calibration: PASSED				
Date: 05.Jun 1999 16:24:54				
Total GAIN Adjust PASSED				
Calibration of IF Filters PASSED				
Bandwidth:				
Filter	Cal Val [Hz]	DAC Val	State	
100kHz	1.804e+03	3698	PASSED	
300kHz	8.417e+03	3516	PASSED	
1MHz	2.806e+04	2881	PASSED	
3MHz	1.804e+03	3698	PASSED	
10MHz	8.417e+03	3516	PASSED	

IEC/IEEE-bus command: CAL:RES?

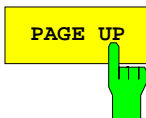

The softkeys *PAGE UP* and *PAGE DOWN* scroll one page forward or backward in the *CALIBRATION RESULTS* table. They have no function when the table is closed.

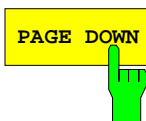

IEC/IEEE-bus command: --



## Markers and Delta Markers – MKR Key

The markers are used for marking points on traces, reading out measurement results and for quickly selecting a display section. ESPI provides four markers per display window. All markers can be used either as markers or delta markers. The availability of marker functions depends on whether the measurement is performed in the frequency, time or level domain.

The marker that can be moved by the user is defined in the following as the **active marker**.

Examples of marker display:

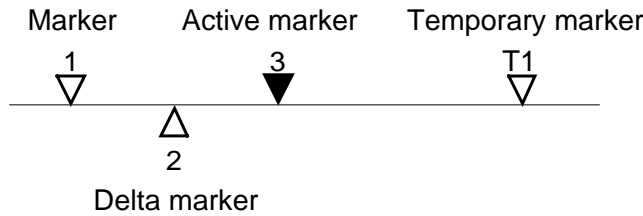

Temporary markers are used in addition to the markers and delta markers to evaluate the measurement results. They disappear when the associated function is deactivated.

The measurement results of the active marker (also called **marker values**) are displayed in the marker field. The marker info field at the upper right of the display shows the marker location (here, frequency), the level and the currently selected trace [T1].

**MARKER 1 [T1]**  
 -27.5 dBm  
 123.4567 MHz

The **MKR** key calls a menu that contains all marker and delta marker standard functions. If no marker is active, **MARKER 1** will be enabled and a peak search on the trace carried out. Otherwise, the data entry for the marker activated last is opened.

**MKR** menu:

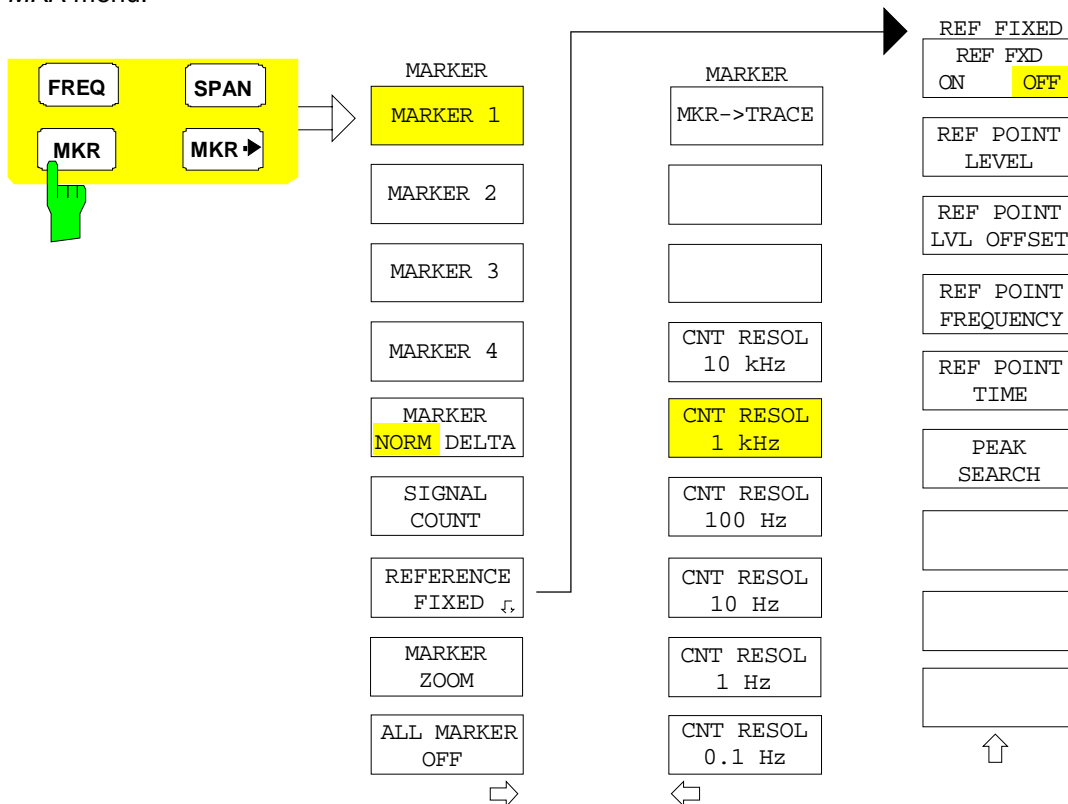

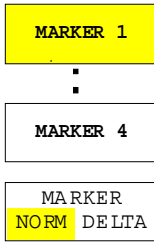

The *MARKER 1/2/3/4* .softkey selects the corresponding marker and activates it.

*MARKER 1* is always the normal marker. After they have been switched on, *MARKERS 2 to 4* are delta markers that refer to *MARKER 1*. These markers can be converted into markers with absolute value display by means of the *MARKER NORM DELTA* softkey. When *MARKER 1* is the active marker, pressing the *MARKER NORM DELTA* softkey switches on an additional delta marker.

Pressing the *MARKER 1 to 4* softkey again switches off the selected marker.

**Example:**

[PRESET] ESPI is set to the default setting.

[MKR] On calling the menu, *MARKER 1* is switched on ('1' highlighted in the softkey) and positioned on the maximum value of the trace. It is a normal marker and the *MARKER NORMAL* softkey is highlighted.

[MARKER 2] *MARKER 2* is switched on ('2' highlighted in the softkey). It is automatically defined as a delta marker on switching on so the *DELTA* is highlighted on softkey *MARKER NORM DELTA*. The frequency and level of *MARKER 2* with reference to *MARKER 1* are output in the marker info field.

[MARKER NORM DELTA] The *MARKER NORM DELTA* softkey is highlighted. *MARKER 2* becomes a normal marker. The frequency and level of *MARKER 2* are output as absolute values in the marker info field.

[MARKER 2] *MARKER 2* is switched off. *MARKER 1* is the active marker for entry. The frequency and level of *MARKER 1* are output in the marker info field.

```
IEC/IEEE-bus command:  CALC:MARK ON;
                        CALC:MARK:X <value>;
                        CALC:MARK:Y?

                        CALC:DELT ON;
                        CALC:DELT:MODE ABS|REL
                        CALC:DELT:X <value>;
                        CALC:DELT:X:REL?
                        CALC:DELT:Y?
```

When several traces are being displayed, the marker is set to the maximum value (peak) of the active trace which has the lowest number (1 to 3). In case a marker is already located there, it will be set to the frequency of the next lowest level (next peak).

When the split-screen display mode is active, the marker will be placed in the active window. A marker can only be enabled when at least one trace in the corresponding window is visible.

If a trace is turned off, the corresponding markers and marker functions are also deactivated. If the trace is switched on again (*VIEW, CLR/WRITE;..*), the markers along with coupled functions will be restored to their original positions provided the markers have not been used on another trace.

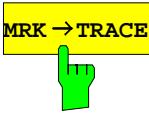

The *MKR*→*TRACE* softkey places the marker on a new trace. The trace is selected via a data entry field. Only those traces can be selected which are visible on the screen in the same window.

**Example:**

Three traces are presented on the screen. The marker is always on Trace 1 on switching on.

[*MKR ->TRACE*]  
"2"<*ENTER*>

The marker jumps to Trace 2 but remains on the previous frequency or time.

[*MKR ->TRACE*]  
"3"<*ENTER*>

The marker jumps to Trace 3. '

IEC/IEEE-bus command:    *CALC:MARK1:TRAC 1*  
                              *CALC:DELT:TRAC 1*

## Frequency Measurement with the Frequency Counter

In order to accurately determine the frequency of a signal, ESPI is equipped with a frequency counter which measures the frequency of the RF signal at the intermediate frequency. Using the measured IF, ESPI calculates the frequency of the RF input signal by applying the known frequency conversion factors.

The frequency measurement error depends only upon the accuracy of the frequency standard used (external or internal reference). Although ESPI always operates synchronously irrespective of the set span, the frequency counter delivers a more exact result than a measurement performed with a marker. This is due to the following:

- The marker measures only the position of the pixel on the trace and infers the frequency of the signal from this value. The trace, however, contains only a limited number of pixels. Depending upon the selected span, each pixel may contain many measurement values, which therefore limits the frequency resolution.
- The resolution with which the frequency can be measured is proportional to the measurement time. For this reason, the bandwidth is normally made as wide as possible and the sweep time as short as possible. This results in a loss of frequency resolution.

For the measurement with the frequency counter, the sweep is stopped at the reference marker, the frequency is counted with the desired resolution and then the sweep is allowed to continue.

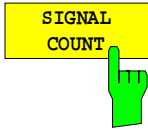

The *SIGNAL COUNT* softkey switches the frequency counter on/off.

The frequency is counted at the position of the reference marker (*MARKER 1*). The sweep stops at the reference marker until the frequency counter has delivered a result. The time required for a frequency measurement depends on the selected frequency resolution. The resolution is set in the side menu.

If no marker is enabled when the *SIGNAL COUNT* softkey is pressed, *MARKER 1* is switched on and set at the largest signal.

In addition, the *SIGNAL COUNT* function is displayed in the marker info field on the screen with [Tx CNT].

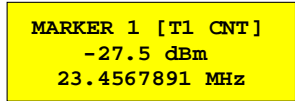

Switching the *SIGNAL COUNT* function off is accomplished by pressing the softkey again.

IEC/IEEE-bus command:            `CALC:MARK1:COUN ON;`  
    `CALC:MARK:COUN:FREQ?`

**MARKER NEXT** menu

The resolution of the frequency counter is set in the *NEXT* menu of the *MARKER* menu. ESPI offers counter resolutions between 0.1 Hz and 10 kHz.

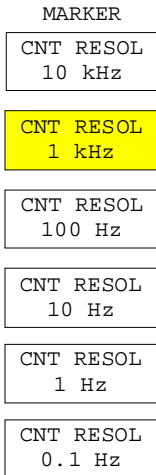

The *CNT RESOL ...* softkeys select the counter resolution. They are selection switches, i.e. only one of the can be active at any one time. The marker stop time, ie the frequency measurement time, depends on the selected resolution.

IEC/IEEE-bus command:            `CALC:MARK1:COUN:RES <value>`

**Measurement example:**

The frequency of a CW signal is to be determined by means of the frequency counter with a resolution of 10 Hz.

**[PRESET]**            ESPI is set to the default setting.

**[MARKER]**            *MARKER 1* is switched on and set to the maximum value of the displayed spectrum.

**[SIGNAL COUNT]**        The frequency counter is switched on. ESPI counts the frequency of the signal at the marker position with a resolution of 1 kHz. The counted frequency is indicated in the marker info field.

**[NEXT]**                Changes to the submenu for setting the counter resolution.

**[CNT RESOL 10 Hz]**      The frequency counter resolution is increased to 10 Hz.

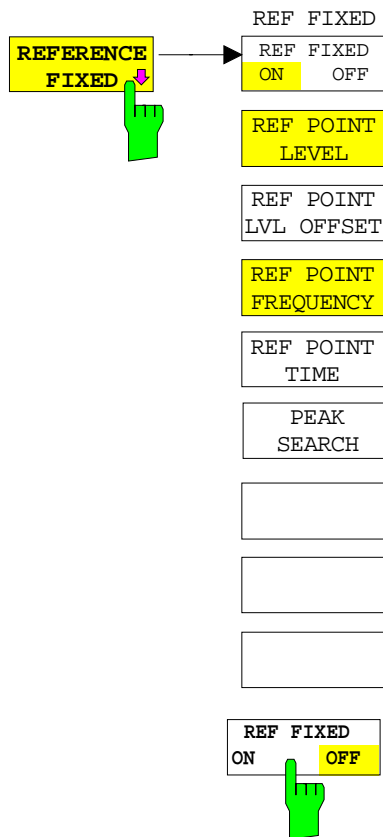

The *REFERENCE FIXED* softkey defines the level and the frequency or time of *MARKER 1* as a reference for one or several delta markers. The measured values for one or several markers displayed in the marker info field are derived from this reference point instead of the current values of the reference marker (*MARKER 1*).

On actuating the softkey, reference fixed is switched on and thus, the level value and the frequency, time or x-level value of *MARKER 1* immediately become the reference point.

Additionally, the *REFERENCE FIXED* softkey opens the sub-menu where it is possible to determine manually a reference point with level and frequency, time or x-axis level, to define a level offset or deactivate the reference point.

The *REFERENCE FIXED* function is useful for the measurement of the harmonic suppression at small span (fundamental not represented).

The *REF FXD ON/OFF* softkey switches on or off the relative measurement to a fixed reference value (*REFERENCE POINT*) independent of the trace.

IEC/IEEE-bus command: `CALC:DELT2:FUNC:FIX ON`

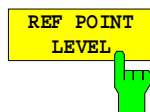

The *REF POINT LEVEL* softkey enters a reference level independent of the reference marker level. All relative level values of the delta markers refer to this reference level.

IEC/IEEE-bus command:

`CALC:DELT2:FUNC:FIX:RPO:Y -10dBm`



The *REF POINT LVL OFFSET* softkey specifies a level offset relevant to the reference level. The relative level values of the delta markers refer to the reference point level plus the level offset.

The level offset is set to 0 dB on enabling the *REFERENCE FIXED* or *PHASE NOISE* function.

IEC/IEEE-bus command:

`CALC:DELT2:FUNC:FIX:RPO:Y:OFFS 0dB`



With the *REF POINT FREQUENCY* softkey a reference frequency can be manually activated for the delta markers when the *REFERENCE FIXED* or *PHASE NOISE* function is used.

IEC/IEEE-bus command:

`CALC:DELT2:FUNC:FIX:RPO:X 10.7MHz`

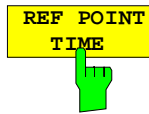

The *REF POINT TIME* softkey activates the entry box for the input of a reference time for the *REFERENCE FIXED* function in the time domain (span = 0 Hz).

IEC/IEEE-bus command:

```
CALC:DELT2:FUNC:FIX:RPO:X 5MS
```

For phase noise measurement, input of reference time is not possible.



The *PEAK SEARCH* sets the reference point level for all delta markers to the peak of the selected trace when the *REFERENCE FIXED* function is used.

IEC/IEEE-bus command: `CALC:DELT:FUNC:FIX:RPO:MAX`

#### Measurement example:

Small-span harmonics measurement to increase sensitivity  
CW signal (eg 100 MHz, 0 dBm) with harmonics at the RF input of ESPI.

- |                      |   |
|----------------------|---|
| [PRESET]             | ESPI is set to the default setting.   |
| [CENTER: 100 MHz]    | The center frequency of ESPI is set to 100 MHz.   |
| [SPAN: 1 MHz]        | The span is set to 1 MHz.   |
| [AMPL: 3 dBm]        | The reference level is set to 3 dBm (3 dB above the expected RF level).   |
| [MKR]                | <i>MARKER 1</i> is switched on ('1' highlighted in the softkey) and set to the signal peak.   |
| [MARKER 2]           | <i>MARKER 2</i> is switched on and automatically defined as the delta marker ( <i>DELTA</i> is highlighted on <i>MARKER NORM DELTA</i> softkey).  |
| [REFERENCE<br>FIXED] | The frequency and level of <i>MARKER 1</i> are a reference for the delta marker.  |
| [CENTER: 200 MHz]    | The center frequency is set to 200 MHz (= frequency of the 2nd harmonic). The reference level may have to be reduced to see the 2nd harmonic from the noise. This does not affect the reference level set with <i>REFERENCE FIXED</i> . |
| [MKR->: PEAK]        | The delta marker jumps to the 2nd harmonic of the signal. The level spacing of the harmonic to the fundamental is displayed in the marker info field.   |

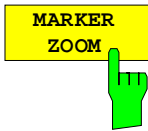

The *MARKER ZOOM* softkey expands the area around *MARKER 1*. With the zoom function, more details of the spectrum can be seen. The desired display range can be defined in an entry window.

The following sweep is stopped at the position of the reference marker. The frequency of the signal is counted and the measured frequency becomes the new center frequency. The zoomed display range is then configured and the new settings are used by ESPI for further measurements.

As long as switching to the new frequency display range has not yet taken place, pressing the softkey will abort the procedure.

If *MARKER 1* is not active when the softkey is pressed, it is automatically activated and set to the highest peak in the window.

If an instrument setting is changed after selection of *MARKER ZOOM*, the function is aborted.

The *MARKER ZOOM* softkey is only available in the frequency domain (span > 0).

IEC/IEEE-bus command: `CALC:MARK1:FUNC:ZOOM 1kHz`



The *ALL MARKER OFF* softkey switches off all markers (reference and delta markers). It also switches off all functions and displays associated with the markers/delta markers.

IEC/IEEE-bus command: `CALC:MARK:AOFF`

## Marker Functions – MKR FCTN Key

The MKR FCTN menu offers further measurements with the markers:

- Measurement of noise density (*NOISE MEAS* softkey)
- Measurement of phase noise (*PHASE NOISE* softkey)
- Measurement of filter or signal bandwidth (*N DB DOWN* softkey)
- Activating of AF demodulation (*MARKER DEMOD* softkey)

On calling the menu, the entry for the last active marker is activated (*SELECT MARKER* softkey); if no marker is activated, marker 1 is activated and a maximum search (*PEAK* softkey) is performed. The marker can be set to the desired trace by means of *MKR -> TRACE* softkey.

Menu *MKR FCTN*:

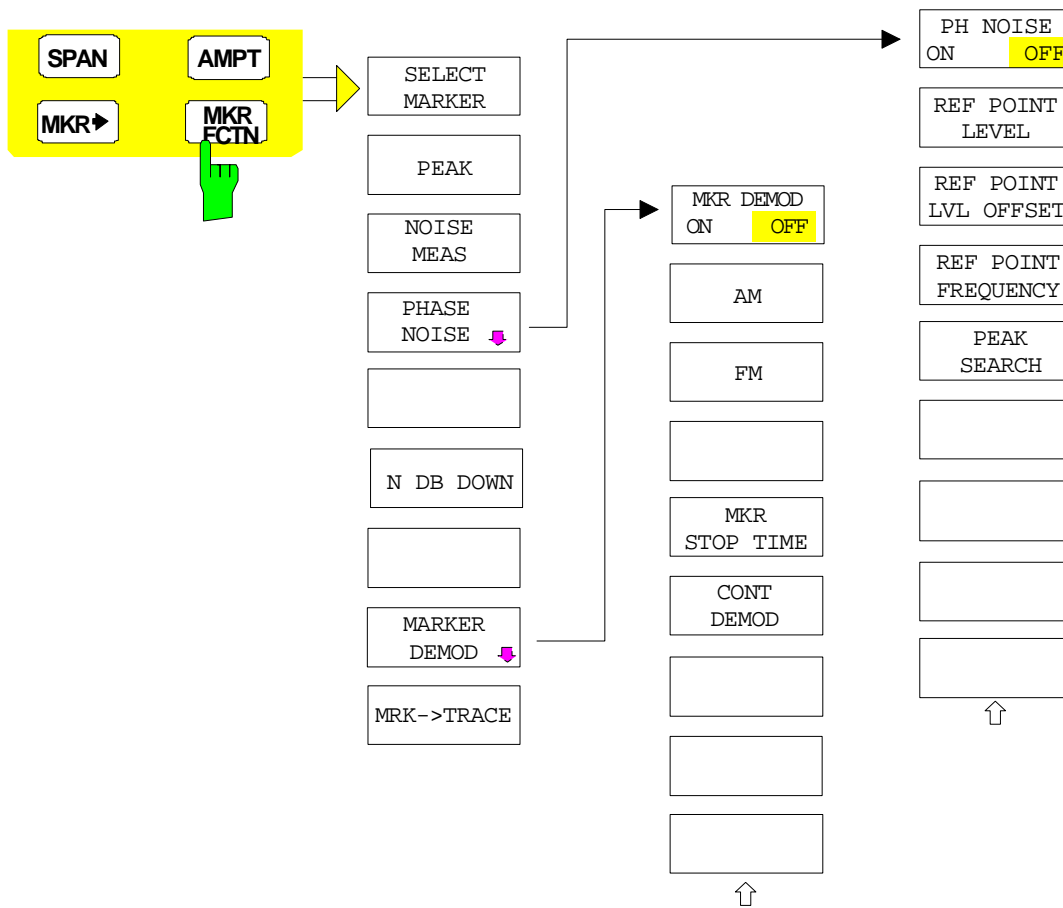



## Activating the Markers

Menu *MKR FCTN*:

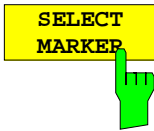

The *SELECT MARKER* softkey activates the numerical selection of the marker in the data entry field. Delta marker 1 is selected by input of '0'. If the marker is switched off, then it is switched on and can be moved later on.

IEC/IEEE-bus command: `CALC:MARK1 ON;`  
`CALC:MARK1:X <value>;`  
`CALC:MARK1:Y?`

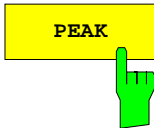

The *PEAK* softkey sets the active marker/delta marker to the peak of the trace.

IEC/IEEE-bus command: `CALC:MARK1:MAX`  
`CALC:DELT1:MAX`

## Measurement of noise density

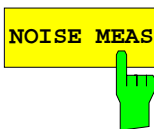

The *NOISE MEAS* softkey switches the noise measurement for the active marker on or off. The corresponding marker becomes the *NORMAL* marker.

During noise measurement, the noise power density is measured at the position of the marker. In the time domain mode, all points of the trace are used to determine the noise power density. When measurements are performed in the frequency domain, two points to the right and left of the marker are used for the measurement to obtain a stable result.

The noise power density is indicated in the marker field. With a logarithmic amplitude units (dBm, dBmV, dBm $\mu$ V, dB $\mu$ A) the noise power density is output in dBm/Hz ie as level in 1 Hz bandwidth with reference to 1 mW. With linear amplitude units (V, A, W) the noise voltage density is evaluated in  $\mu$ V/ $\sqrt$ Hz, the noise current density in  $\mu$ A/ $\sqrt$ Hz or the noise power density in  $\mu$ W/Hz.

The following settings have to be made to ensure that the power density measurement yields correct values:

Detector:            Sample or RMS

Video bandwidth:

- $\leq 0.1$  x resolution bandwidth with sample detector  
(corresponds to RBW / VBW NOISE)
- $\geq 3$  x resolution bandwidth with RMS detector  
(corresponds to RBW / VBW SINE)

In the default setting, ESPI uses the sample detector for the noise function.

With the sample detector, the trace can additionally be set to AVERAGE to stabilize the measured values. With RMS detector used, trace averaging must not be used since in this case it produces too low noise levels which cannot be corrected. Instead, the sweep time can be increased to obtain stable measurement results.

The ESPI uses the following correction factors to evaluate the noise density from the marker level:

- Since the noise power is indicated with reference to 1 Hz bandwidth, the bandwidth correction value is deducted from the marker level. It is  $10 \times \lg(1\text{Hz}/\text{BW}_{\text{Noise}})$ , where  $\text{BW}_{\text{Noise}}$  is the noise or power bandwidth of the set resolution filter (RBW).

**Sample detector:**

- As a result of video filter averaging and trace averaging, 1.05 dB is added to the marker level. This is the difference between the average value and the rms value of white noise.
- With a logarithmic level axis, 1.45 dB is added additionally. Logarithmic averaging is thus fully taken into account which yields a value that is 1.45 dB lower than that of linear averaging.

**RMS detector:**

- With the exception of bandwidth correction, no further corrections are required for the RMS detector since it already indicates the power with every point of the trace.

To allow a more stable noise display the adjacent (symmetric to the measurement frequency) points of the trace are averaged.

In time domain mode, the measured values are averaged versus time (after a sweep).

IEC/IEEE-bus command:            `CALC:MARK:FUNC:NOIS ON;`  
    `CALC:MARK:FUNC:NOIS:RES?`

**Example:** Measurement of inherent ESPI noise

- [PRESET]**            ESPI is set to default setting.
- [MARKER]**            Marker 1 is switched on and set to the maximum value of the displayed spectrum. Set marker to desired frequency using the rotary knob.
- [NOISE]**              The ESPI switches the sample detector on and sets the video bandwidth to 300 kHz (0.1 x RBW). The power density level of inherent noise is displayed in dBm/Hz in the marker info field.

**Note:**                *The ESPI noise figure can be calculated from the measured power density level. It is calculated by deducting the set RF attenuation (RF Att) from the displayed noise level. 174 is to be added to the result to obtain the ESPI noise figure.*

## Phase Noise Measurement

Menu MKR FCTN:

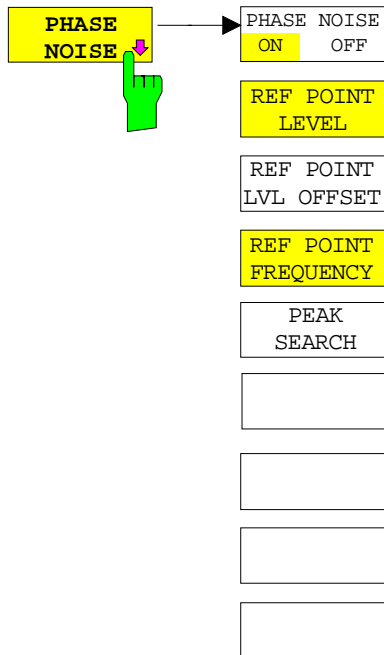

The *PHASE NOISE* softkey switches the *PHASE NOISE* function on/off. Additionally, the softkey opens the submenu for manually setting the reference point. The phase noise measurement can be switched off in the submenu.

*MARKER 1* (= reference marker) is used as a reference for the phase noise measurement. The frequency and level of the reference marker are used as fixed reference values, ie the *REFERENCE FIXED* function is activated. After switching on the phase noise measurement the reference level or the center frequency can thus be set in a way that the carrier is outside the displayed frequency range, or, for example, a notch filter is switched on to suppress the carrier.

A noise power density measurement is carried out with the delta marker or delta markers. This measurement corresponds to the *NOISE* function in the *MARKER* menu (MKR). The result of the phase noise measurement is the difference in level between the reference point and the noise power density.

The following possibilities can be selected on switching on *PHASE NOISE*:

1. No marker enabled:

[MKR FCTN] *MARKER 1* is enabled and set to peak.  
 [PHASE NOISE] *MARKER 1* becomes the reference marker, *MARKER 2* the delta marker; frequency = frequency of the reference marker. The delta marker is the active marker, ie it can be moved with the rollkey or adjusted by entering numerals. The *PHASE NOISE* function is switched on and the measured value is output.

2. Markers are enabled:

[MKR FCTN] The previous marker configuration remains unchanged.  
 [PHASE NOISE] *MARKER 1* becomes the reference marker. If other markers are enabled, they become delta markers and measure the phase noise at their respective positions.

If further markers are enabled during the phase noise measurement, they automatically become delta markers and measure the phase noise at their respective positions.

When the phase noise measurement is switched off, the marker configuration remains unchanged and the delta markers measure the relative level to the reference marker (*MARKER 1*).

The *PHASE NOISE* function measures the noise power at the delta markers referred to 1 Hz bandwidth. The sample detector is automatically used and the video bandwidth set to 0.1 times the resolution bandwidth (RBW). The two settings are taken into account in the correction values used for the noise power measurement.

To obtain stable results, two pixels on the right and the left of the respective delta marker position are taken for the measurement. The procedure for determining the noise power is identical to the method used for the noise power measurement (see *NOISE* softkey). The measured noise level referred to 1 Hz bandwidth is subtracted from the carrier level at the reference marker (*MARKER 1*). The measured values are displayed in the delta marker field in dBc/Hz (= spacing in dB of the noise power from the carrier level in 1 Hz bandwidth).

If several delta markers are enabled, only the value read by the active marker is shown in the marker field. If several delta markers are active, their measurement results are shown in the marker info field.

The reference value for the phase noise measurement can be defined with *REF POINT LEVEL*, *REF POINT FREQUENCY* and *REF POINT LVL OFFSET* to differ from that of the reference marker.

IEC/IEEE-bus command: --

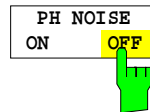

The *PH NOISE ON/OFF* softkey switches on/off the phase noise measurement. Switching on is performed by means of the *PHASE NOISE* softkey and is only necessary when the phase noise measurement has been switched off in the submenu.

IEC/IEEE-bus command: `CALC:DELT1:FUNC:PNO ON`  
`CALC:DELT1:FUNC:PNO:RES?`



The *REF POINT LEVEL* softkey activates an entry box for the input of a reference level other than the reference marker level. The function is identical to that of the softkey with the same name in the marker menu (MKR).

IEC/IEEE-bus command: `CALC:DELT1:FUNC:FIX:RPO:Y -10dB`



The *REF POINT LVL OFFSET* softkey activates an entry box for the input of an additional level offset for the phase noise calculation.

This level offset is set to 0 dB on when the *REFERENCE FIXED* or *PHASE NOISE* function is enabled.

IEC/IEEE-bus command: `CALC:DELT:FUNC:FIX:RPO:Y:OFFS 10dB`

REF POINT  
FREQUENCY

The *REF POINT FREQUENCY* softkey activates an entry box for the manual input of a reference frequency for the *REFERENCE FIXED* or *PHASE NOISE* function.

IEC/IEEE-bus command:

CALC:DELT1:FUNC:FIX:RPO:X 10.7MHz

PEAK  
SEARCH

The *PEAK SEARCH* sets the reference point level for delta marker 2 in the selected measurement window to the peak of the selected trace.

IEC/IEEE-bus command: CALC:DELT:FUNC:FIX:RPO:MAX

### Measurement example:

The phase noise of a CW signal at 100 MHz with 0 dBm level is to be measured at 800 kHz from the carrier

[PRESET]	ESPI is set to the default setting.
[CENTER: 100 MHz]	The center frequency is set to 100 MHz.
[SPAN: 2 MHz]	The span is set to 2 MHz.
[AMPT: 0 dBm]	The reference level is set to 0 dBm.
[MKR FCTN]	<i>MARKER 1</i> is switched on and positioned at the maximum of the displayed trace.
[PHASE NOISE: 800 kHz]	The phase noise measurement is switched on. The delta marker is positioned on the main marker and the measured phase noise value is displayed in the marker info field. The sample detector is used and the video bandwidth is set to 3 x RBW. When the phase noise measurement function is enabled, the entry of the delta marker frequency is activated. It can be entered directly.

## Measurement of the Filter or Signal Bandwidth

Menu *MKR FCTN*:

N dB DOWN



The *N dB DOWN* softkey activates the temporary markers T1 and T2 which are n dB below the active reference marker. Marker T1 is placed to the left and marker T2 at the right of the reference marker. The value n can be input in a window.

The default setting is 3 dB.

The frequency spacing of the two temporary markers is indicated in the marker info field.

If, for example, it is not possible to form the frequency spacing for the n dB value because of the noise display, dashes are indicated instead of a measured value.

IEC/IEEE-bus command: CALC:MARK1:FUNC:NDBD:STAT ON  
CALC:MARK1:FUNC:NDBD 3dB  
CALC:MARK1:FUNC:NDBD:RES?  
CALC:MARK1:FUNC:NDBD:FREQ?

## AF Demodulation

The ESPI provides demodulators for AM and FM signals. With these demodulators, a displayed signal can be identified acoustically through the use of the internal loudspeaker or with headphones. The frequency at which the demodulation is enabled is coupled to the markers. The sweep stops at the frequency determined by the active marker for the selected time and the RF signal is demodulated. During a measurement in the time domain (span = 0 Hz) the demodulation is continuously on. The threshold line (*MKR->SEARCH LIMITS:THRESHOLD*) performs a squelch function in the demodulator. If the threshold is set, the ESPI LF demodulation is switched on only when the signal to be demodulated exceeds the set threshold.

Menu *MKR FCTN*:

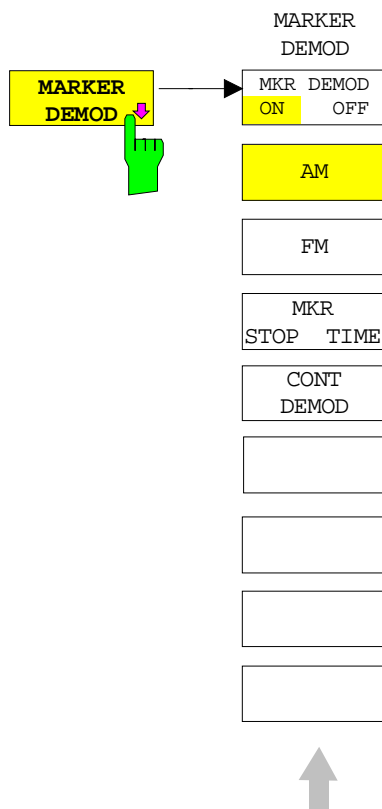

The *MARKER DEMOD* softkey switches on the audio demodulator and calls a submenu in which the demodulation mode and the duration of the demodulation can be selected.

IEC/IEEE-bus command: `CALC:MARK1:FUNC:DEM ON`

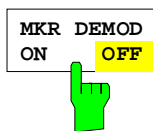

The *MKR DEMOD ON/OFF* softkey switches the demodulation on/off.

In the frequency range (span >0), the frequency scan is stopped at the frequency of the active marker with demodulation switched on – provided that the level is above the threshold line - and the signal is demodulated during the given stop time.

In the time domain (span = 0) demodulation is continuous, ie not only active at the marker position.

IEC/IEEE-bus command: `CALC:MARK1:FUNC:DEM ON`



The *MKR STOP TIME* softkey defines the stop time for demodulation at the marker or markers.

ESPI stops the sweep at the marker or markers for the duration of the defined stop time and then switches the demodulation on (see also *MKR DEMOD ON/OFF*).

IEC/IEEE-bus command: `CALC:MARK1:FUNC:DEM:HOLD 3s`

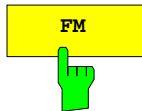
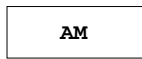

The softkeys *AM* and *FM* are selector switches one of which only may be active at a time. They set the desired demodulation mode FM or AM. Default setting is AM.

IEC/IEEE-bus command: `CALC:MARK1:FUNC:DEM:SEL AM`  
`CALC:MARK1:FUNC:DEM:SEL FM`



The *MKR STOP TIME* softkey defines the stop time for demodulation at the marker(s).

The ESPI interrupts the frequency sweep at the marker position and activates the demodulation for the duration of the stop time (see also *MKR DEMOD ON/OFF*).

In the time domain (span = 0) the demodulation is continuously active irrespective of the stop time set.

IEC/IEEE-bus command: `CALC:MARK1:FUNC:DEM:HOLD 3s`

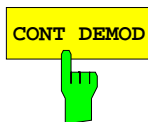

The *CONT DEMOD* softkey switches on the continuous demodulation in the frequency domain. If the sweep time is long enough, the set frequency range can be monitored acoustically.

IEC/IEEE-bus command: `CALC:MARK1:FUNC:DEM:CONT ON`

## Selecting the Trace

Menu *MKR FCTN*:



The *MKR -> TRACE* softkey sets the active marker to different traces. Only those traces can be selected which are visible on the screen in the same window.

The function of the softkey is identical to that of the softkey with the same name in the *MKR->* menu.

### Example:

Three traces are displayed on the screen. The marker is always on Trace 1 on switching on.

`[MKR ->TRACE]`

"1"<ENTER> The marker jumps to Trace 2, but remains at the previous frequency or time.

`[MKR ->TRACE]`

"3"<ENTER> The marker jumps to Trace 3.

IEC/IEEE-bus command: `CALC:MARK:TRAC 2`

## Change of Settings via Markers – MKR ⇒ Key

The MKR → menu offers functions through which instrument parameters can be changed with the aid of the currently active marker. The functions can be used on markers and delta markers.

On opening the menu, the entry for the last active marker is activated; if no marker was enabled, *MARKER 1* is activated and a peak search is performed.

MKR → menu

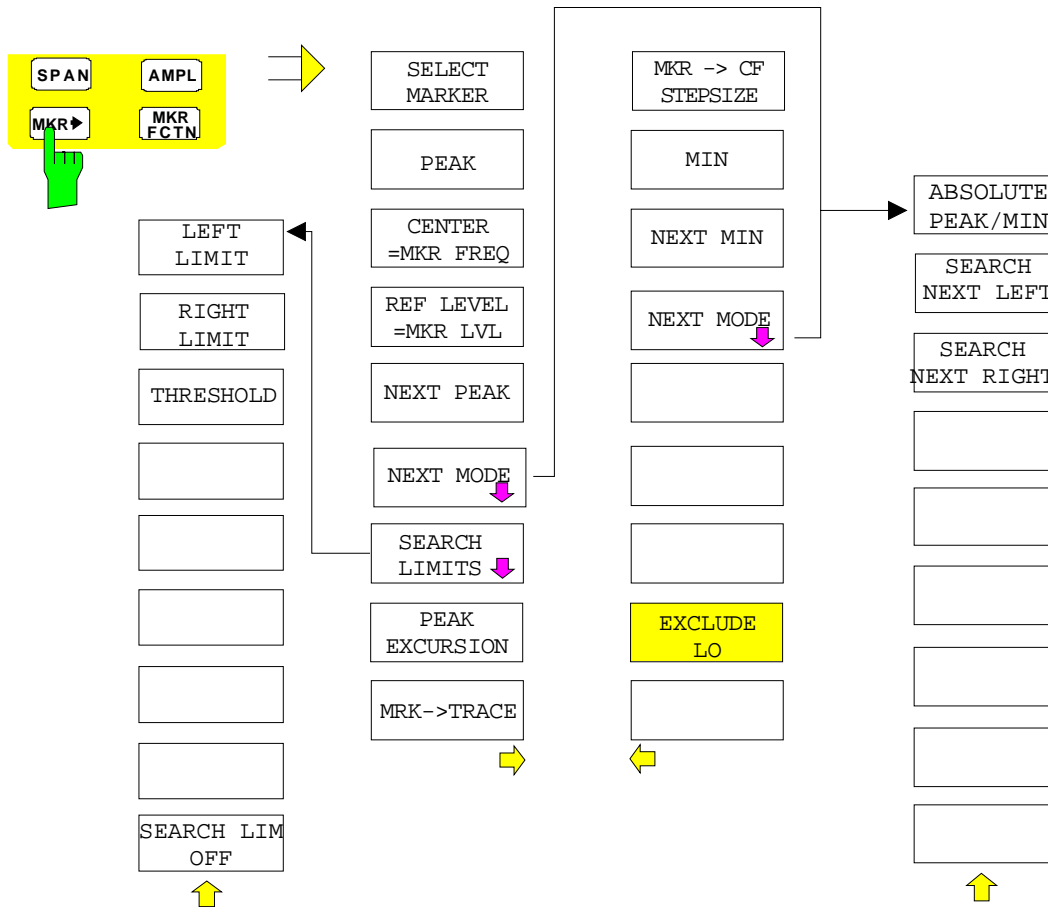

The *SELECT MARKER* softkey activates the numerical selection of the marker in the data entry field. Delta marker 1 is selected by input of '0'.

IEC/IEEE-bus command: `CALC:MARK1 ON;`  
`CALC:MARK1:X <value>;`  
`CALC:MARK1:Y?`

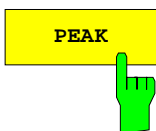

The *PEAK* softkey sets the active marker or delta marker to the peak of the trace.

If no marker is active when **MKR->** menu is called, *MARKER 1* is automatically switched on and the peak search is performed.

IEC/IEEE-bus command: `CALC:MARK:MAX`  
`CALC:DELT:MAX`





The *CENTER = MKR FREQ* softkey sets the center frequency to the current marker or delta marker frequency.

A signal can thus be set to the center of the frequency display range, for example, so that it can then be examined in detail with a smaller span.

The softkey is not available in the time domain (zero span).

IEC/IEEE-bus command: `CALC:MARK:FUNC:CENT`

#### Example:

A spectrum is displayed with a large span after PRESET. A signal off the center is to be examined in detail:

[PRESET] ESPI is set to the default setting.

[MKR->] *MARKER 1* is switched on and automatically jumps to the largest signal of the trace.

[*CENTER =MKR FREQ*] The center frequency is set to the marker frequency. The span is adapted in such a way that the minimum frequency (= 0 Hz) or the maximum frequency is not exceeded.

[SPAN] The span can, for example, be reduced using the rollkey.



The *REF LEVEL = MKR LVL* softkey sets the reference level to the current marker level.

IEC/IEEE-bus command: `CALC:MARK:FUNC:REF`

#### Example:

A spectrum is displayed with a large span after PRESET. A signal off the center is to be examined in detail:

[PRESET] ESPI is set to the default setting.

[MKR->] *MARKER 1* is switched on and automatically jumps to the largest signal of the trace.

[*CENTER =MKR FREQ*] The center frequency is set to the marker frequency. The span is adapted in such a way that the minimum frequency (= 0 Hz) or the maximum frequency is not exceeded.

[*REF LEVEL = MKR LVL*] The reference level is set to the measured marker level.

[SPAN] The span can, for example, be reduced using the rollkey.

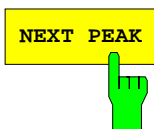

The *NEXT PEAK* softkey sets the active marker/delta marker to the next lower peak value on the trace. The search direction is defined in the *NEXT MODE* submenu (see below).

IEC/IEEE-bus command: `CALC:MARK:MAX:NEXT`  
`CALC:DELT:MAX:NEXT`

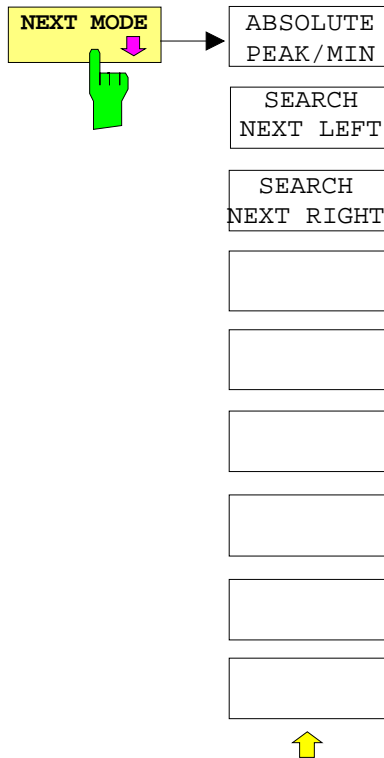

The *NEXT MODE* softkey opens a sub menu for definition of the search direction for *NEXT PEAK* and *NEXT MIN*.

The softkeys are selection switches, ie only one of them can be active at any one time.

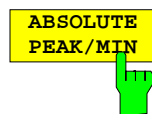

The *ABSOLUTE PEAK/MIN* softkey defines that the next higher maximum or minimum is searched for on the whole trace.

IEC-Bus-Befehle:      CALC : MARK : MAX : NEXT  
                           CALC : DELT : MAX : NEXT  
                           CALC : MARK : MIN : NEXT  
                           CALC : DELT : MIN : NEXT

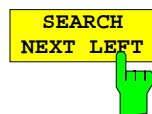

The *SEARCH NEXT LEFT* softkey defines that the next higher maximum or minimum on the left of the active marker is searched for, ie only frequencies or time values smaller than the current marker frequency or time are taken into account.

IEC-Bus-Befehle:      CALC : MARK : MAX : LEFT  
                           CALC : DELT : MAX : LEFT  
                           CALC : MARK : MIN : LEFT  
                           CALC : DELT : MIN : LEFT

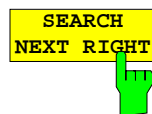

The *SEARCH NEXT RIGHT* softkey defines that the the next higher maximum or minimum on the right of the active marker is searched for, ie only frequencies or time values higher than the current marker frequency or time are taken into account.

IEC-Bus-Befehle:      CALC : MARK : MAX : RIGH  
                           CALC : DELT : MAX : RIGH  
                           CALC : MARK : MIN : RIGH  
                           CALC : DELT : MIN : RIGH

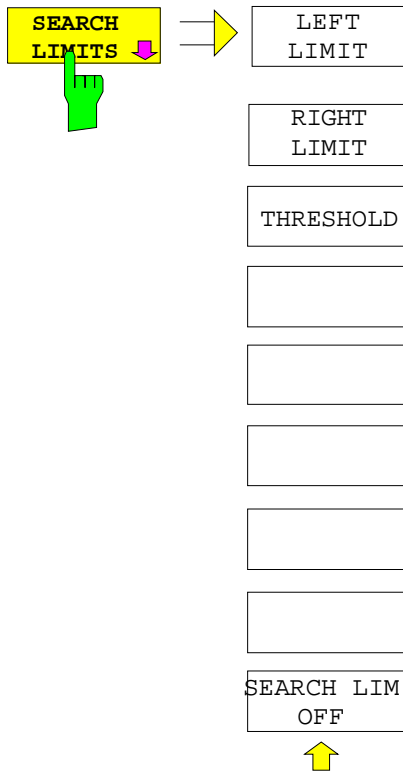

The *SEARCH LIMITS* softkey limits the search range for maximum or minimum search. The softkey switches to a submenu in which the search range limits can be set in the x and y direction.

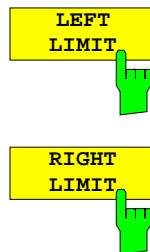

The *LEFT LIMIT* und *RIGHT LIMIT* softkeys define the two vertical lines F1 and F2 in the frequency domain (span > 0) and T1 / T2 in the time domain (span = 0). The search is performed between these lines in the frequency and time domain. If only one line is enabled, line F1/T1 is the lower limit and the upper limit corresponds to the stop frequency. If F2/T2 is also enabled, it determines the upper limit.

IEC/IEEE-bus command: `CALC:MARK:X:SLIM:LEFT 1MHZ`  
`CALC:MARK:X:SLIM:RIGH 10MHZ`  
`CALC:MARK:X:SLIM ON`



The *THRESHOLD* softkey defines the threshold line. The threshold line represents a limit for the level range of the max. search at the lower end and that of the min. search at the upper end.

IEC/IEEE-bus command: `CALC:THR -20dBm`  
`CALC:THR ON`



The *SEARCH LIMIT OFF* softkey disables all limits of the search range.

IEC/IEEE-bus command: `CALC:MARK:X:SLIM OFF`  
`CALC:THR OFF`

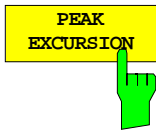

The *PEAK EXCURSION* softkey activates an entry box for selecting the minimum amount by which a signal level must decrease/increase before it is recognized by the *NEXT PEAK* and *NEXT MIN* search functions as a maximum or minimum.

Input values from 0 to 80 dB are allowed, the resolution being 0.1 dB.

IEC/IEEE-bus command: `CALC:MARK:PEXC 10dB`

The peak excursion is preset to 6 dB. This is sufficient for the *NEXT PEAK* (or *NEXT MIN*) functions in the *NEXT MODE ABS* setting as always the next smaller (or larger) signal is searched for.

In the *SEARCH NEXT LEFT* or *SEARCH NEXT RIGHT* setting, functions *NEXT PEAK* and *NEXT MIN* search for the next relative maximum or minimum on the right or left of the current marker position irrespective of the instantaneous signal amplitude. A relative maximum is given when the signal amplitude on both sides of the maximum is reduced by a certain amount, ie the peak excursion.

The preset 6 dB level change can already be reached by the noise indication of the ESPI. Noise maxima are identified as peaks. In this case, *PEAK EXCURSION* has to be selected with a higher value than the difference between the highest and lowest noise indication values.

The following example shows the effect of different *PEAK EXCURSION* settings.

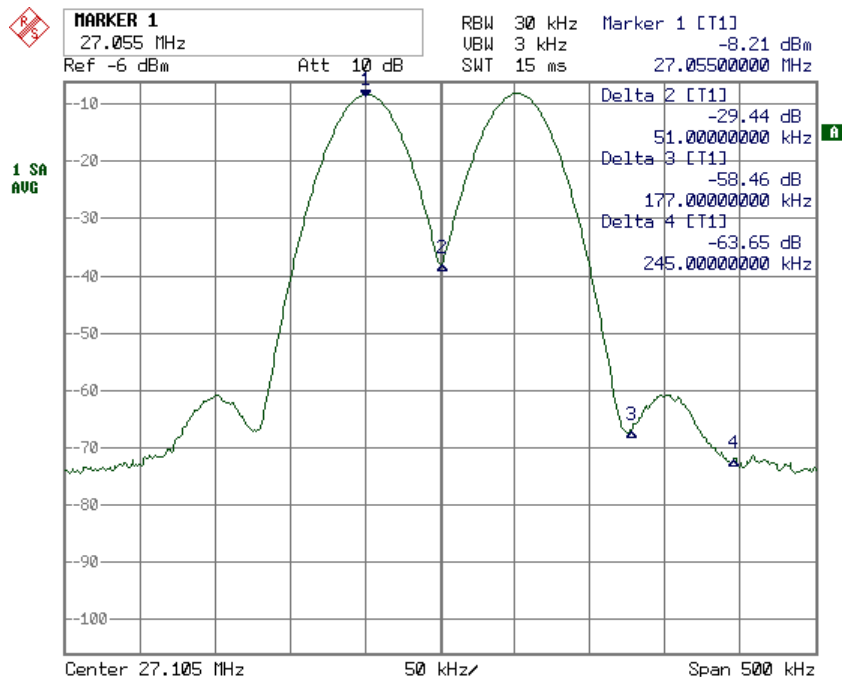

Fig. 4-12 Example for level measurements at different peak excursion settings

Maximum relative level change of the measured signals:

Signal 2:	42 dB
Signal 3	30 dB
Signal 4:	46 dB

The setting **Peak Excursion 40 dB** causes signals 2 and 4 to be detected with *NEXT PEAK* or *NEXT PEAK RIGHT*. Signal 3 is not detected since it only decreases by 30 dB before the level rises again.

Order of signals found:

PEAK:	Signal 1
NEXT PEAK:	Signal 2
NEXT PEAK:	Signal 4

or

PEAK:	Signal 1
NEXT PEAK RIGHT:	Signal 2
NEXT PEAK RIGHT:	Signal 4

The setting **Peak Excursion 20 dB** causes signal 3 to be detected as well since its highest level change of 30 dB is now higher than the set peak excursion.

Order of signals found:

PEAK:	Signal 1
NEXT PEAK:	Signal 2
NEXT PEAK:	Signal 4
NEXT PEAK:	Signal 3

or

PEAK:	Signal 1
NEXT PEAK RIGHT:	Signal 2
NEXT PEAK RIGHT:	Signal 3
NEXT PEAK RIGHT:	Signal 4

The setting **Peak Excursion 6 dB** detects all the signals, *NEXT PEAK RIGHT* does not work as required.

Order of signals found:

PEAK:	Signal 1
NEXT PEAK:	Signal 2
NEXT PEAK:	Signal 4
NEXT PEAK:	Signal 3

or

PEAK:	Signal 1
NEXT PEAK RIGHT:	Marker in noise between signal 1 and signal 2
NEXT PEAK RIGHT:	Marker in noise between signal 1 and signal 2

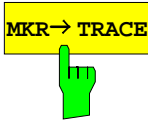

The *MKR*→*TRACE* softkey sets the active marker to a new trace. If only one trace is available on the screen, the softkey does not appear. If several traces are available on the screen, only these are offered.

IEC/IEEE-bus command: `CALC:MARK:TRAC 2`

#### Example:

Three traces are displayed on the screen. The marker is always on Trace 1 after switching on.

[*MKR* ->*TRACE*] "2" <*ENTER*> The marker jumps to Trace 2 but remains at the previous frequency or time.

[*MKR* ->*TRACE*] "3" <*ENTER*> The marker jumps to Trace 3.



The *MKR*→*CF STEPSIZE* softkey sets the step size for the center frequency variation to the current marker frequency, and also sets step size adaptation to *MANUAL*. *CF STEPSIZE* remains at this value until the center frequency entry mode in the STEP menu is switched from *MANUAL* to *AUTO* again.

The *MKR*→*CF STEPSIZE* function is, above all, useful in the measurement of harmonics with large dynamic range (narrow bandwidth and narrow span).

The softkey is not available in the time domain (span = 0 Hz).

IEC/IEEE-bus command: `CALC:MARK:FUNC:CST`

#### Example:

The harmonics levels of a CW carrier are to be measured at 100 MHz.

[**PRESET**] ESPI is set to the default setting.

[**CENTER: 100 MHz**] ESPI sets the center frequency to 100 MHz. The span is set to 200 MHz.

[**SPAN: 1 MHz**] The span is set to 100 MHz.

[**MKR->**] *MARKER 1* is switched on and set to the maximum value of the signal.

[**NEXT**] ESPI switches to the submenu.

[ *MKR*->*CF STEPSIZE*] The step size of the center frequency setting equals the marker frequency (100 MHz).

[**CENTER**] The center frequency entry mode is activated.

[**Right key**] The center frequency is set to 200 MHz. The first harmonic of the test signal is displayed.

[**MKR->: PEAK**] The marker is set to the harmonic and the level of the latter is output in the marker info field.

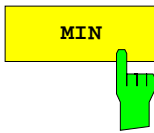

The *MIN* softkey sets the active marker to the minimum value on the corresponding trace.

IEC/IEEE-bus command: `CALC:MARK:MIN`  
`CALC:DELT:MIN`

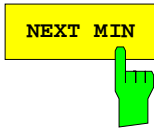

The *NEXT MIN* softkey sets the active marker to the next higher minimum value on the corresponding trace. The search direction is defined in the *NEXT MODE* submenu (see above).

IEC/IEEE-bus command: `CALC:MARK:MIN:NEXT`  
`CALC:DELT:MIN:NEXT`

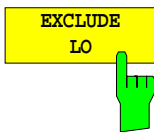

The *EXCLUDE LO* softkey limits the frequency range for the marker search functions or disables the limit.

activated Because of the feedthrough of the first local oscillator to the first intermediate frequency at the input mixer, the LO is represented as a signal at 0 Hz. To avoid the marker jumping to the LO at 0 Hz with the peak function when setting the display range, this frequency is excluded. The minimum frequency to which the marker jumps, is  $\geq 6 \times$  resolution bandwidth (RBW).

deactivated No restriction to the search range. The frequency 0 Hz is included in the marker search functions.

IEC/IEEE-bus command: `CALC:MARK:LOEX ON`

## Power Measurements – Hardkey MEAS

With its power measurement functions the ESPI is able to measure all the necessary parameters with high accuracy in a wide dynamic range.

A modulated carrier is almost always used (except eg: SSB-AM) for high-frequency transmission of information. Due to the information modulated upon the carrier, the latter covers a spectrum which is defined by the modulation, the transmission data rate and the signal filtering. Within a transmission band each carrier is assigned a channel taking into account these parameters. In order to ensure error-free transmission, each transmitter must be conforming to the specified parameters. These include among others:

- the output power,
- the occupied bandwidth, ie the bandwidth which must contain a defined percentage of the power and
- the power dissipation allowed in the adjacent channels.

Additionally the menu contains functions to determine the modulation depth of AM modulated signals and to measure the 3<sup>rd</sup> order intercept point.

The measurements and the corresponding settings are selected in the MEAS menu.

MEAS menu:

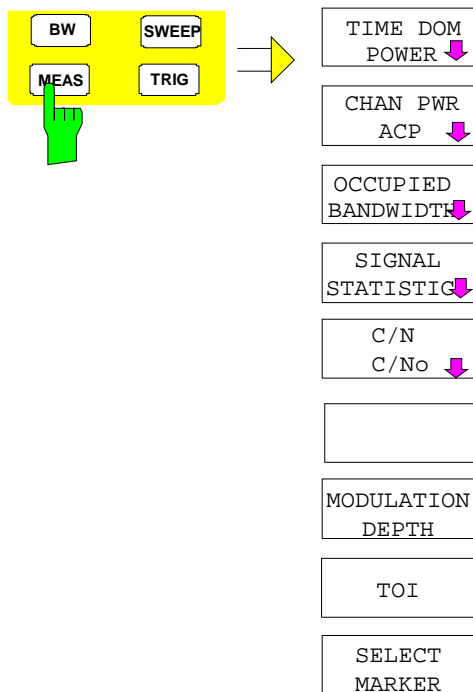

The MEAS key opens the menu to select and set the power measurement.

The following measurements can be selected:

- Power in time domain (*TIME DOM POWER*)
- Channel power and adjacent-channel power in frequency domain (*CHAN PWR /ACP*)
- Occupied bandwidth (*OCCUPIED BANDWIDTH*)
- Carrier-to-noise ratio (*C/N, C/No*)
- Amplitude probability distribution (*SIGNAL STATISTICS*)
- Modulation depth (*MODULATION DEPTH*)
- 3<sup>rd</sup> order intercept (*TOI*)

The above measurements are carried out alternatively.



### Power Measurement in Time Domain

With the aid of the power measurement function the ESPI determines the power of the signal in the time domain (SPAN = 0 Hz) by summing up the power at the individual pixels and dividing the result by the number of pixels. In this way it is possible to measure for example the power of TDMA signals during transmission or during the muting phase. Both the mean power and the rms power can be measured by means of the individual power values.

The result is displayed in the marker info field.

The measured values are updated after each sweep or averaged over a user-defined number of sweeps (AVERAGE ON/OFF and NUMBER OF SWEEPS) in order to determine eg the mean power over several bursts. For determination of the peak value (MAX HOLD ON) the maximum value from several sweeps is displayed.

**Example:**

Marker info field for: MEAN selected, AVERAGE ON and MAX HOLD ON:

```
MEAN HOLD      -2.33 dBm
MEAN AV        -2.39 dBm
```

If both the on and off phase of a burst signal are displayed, the measurement range can be limited to the transmission or to the muting phase with the aid of vertical lines. The ratio between signal and noise power of a TDMA signal for instance can be measured by using a measurement as a reference value and after that varying the measurement range.

Upon switching on power measurement the sample detector is activated (TRACE-DETECTOR-SAMPLE).

Submenu MEAS - TIME DOM POWER:

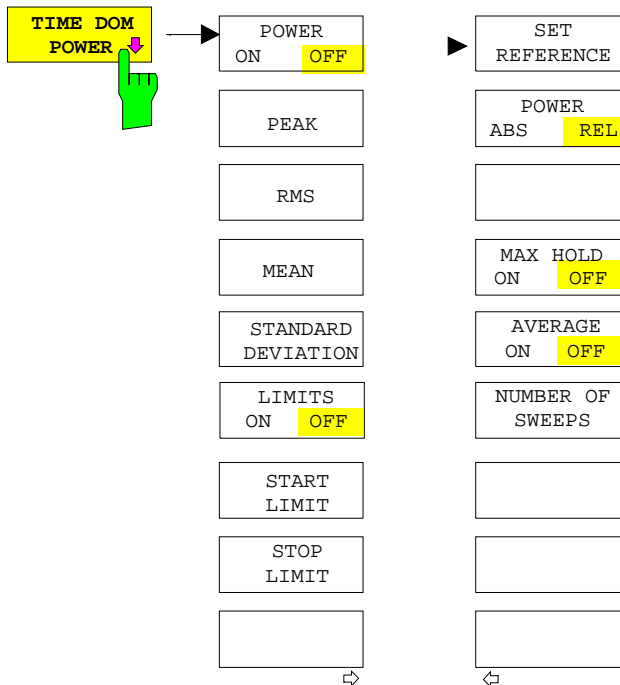

The *TIME DOM POWER* softkey activates the power measurement in the time domain and opens a submenu for configuration of the power measurement.

The submenu allows selection of the type of power measurement (rms or mean power), the settings for max hold and averaging as well as the definition of limits.

The power evaluation range can be limited by input of limit values.

**Note:** This softkey is only available in time domain (SPAN = 0).

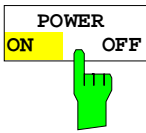

The *POWER ON/OFF* softkey switches the power measurement on and off. When entering the submenu it is *ON* since the power measurement is already switched on with the *TIME DOM POWER* softkey in the main menu.

**Note:** *The measurement is performed on the trace on which marker 1 is placed. To evaluate another trace, marker 1 should be set on another trace using the SELECT TRACE softkey in menu MKR.*

IEC/IEEE-bus command:      `CALC:MARK:FUNC:SUMM:PPE ON`  
                                  `CALC:MARK:FUNC:SUMM:PPE:RES?`  
                                  `CALC:MARK:FUNC:SUMM:RMS ON`  
                                  `CALC:MARK:FUNC:SUMM:RMS:RES?`  
                                  `CALC:MARK:FUNC:SUMM:MEAN ON`  
                                  `CALC:MARK:FUNC:SUMM:MEAN:RES?`  
                                  `CALC:MARK:FUNC:SUMM:SDEV ON`  
                                  `CALC:MARK:FUNC:SUMM:SDEV:RES?`

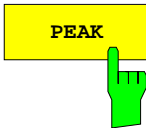

The *PEAK* softkey switches on the calculation of the peak value from the points of the displayed trace or a segment thereof.

For the maximum peak, the largest peak value obtained since the activation of *MAX HOLD ON* is displayed.

With *AVERAGE ON*, the peak values of a trace are averaged over several sweeps and displayed.

The number of sweeps over which the average or the maximum value is calculated is set with the *NUMBER OF SWEEPS* softkey.

IEC/IEEE-bus command:      `CALC:MARK:FUNC:SUMM:PPE ON`  
                                  `CALC:MARK:FUNC:SUMM:PPE:RES?`

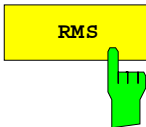

The *RMS* softkey switches on the calculation of the rms value from the points of the displayed trace or a segment of it.

For the maximum peak, the largest rms value obtained since the activation of *MAX HOLD ON* is displayed.

With *AVERAGE ON*, the rms values of a trace are averaged over several sweeps and displayed.

The number of sweeps over which the average or the maximum value is calculated is set with the *NUMBER OF SWEEPS* softkey.

IEC/IEEE-bus command:      `CALC:MARK:FUNC:SUMM:RMS ON`  
                                  `CALC:MARK:FUNC:SUMM:RMS:RES?`

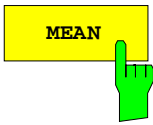

The *MEAN* softkey switches on the calculation of the mean value from the points of the displayed trace or a segment of it. The linear mean value of the equivalent voltages is calculated.

This can be used for instance to measure the mean power during a GSM burst.

For the maximum peak, the largest mean value obtained since the activation of *MAX HOLD ON* is displayed.

With *AVERAGE ON*, the mean values of a trace are averaged over several sweeps and displayed.

The number of sweeps over which the average or the maximum value is calculated is set with the *NUMBER OF SWEEPS* softkey.

IEC/IEEE-bus command:    `CALC:MARK:FUNC:SUMM:MEAN ON`  
                                   `CALC:MARK:FUNC:SUMM:MEAN:RES?`

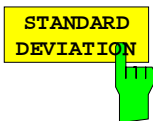

The *STANDARD DEVIATION* softkey switches on the calculation of the standard deviation of trace points from the mean value and outputs them as measured value. The measurement of the mean power is automatically switched on at the same time.

For the maximum peak, the largest standard deviation obtained since the activation of *MAX HOLD ON* is displayed.

With *AVERAGE ON*, the standard deviations of a trace are averaged over several sweeps and displayed.

The number of sweeps over which the average or the maximum value is calculated is set with the *NUMBER OF SWEEPS* softkey.

IEC/IEEE-bus command:    `CALC:MARK:FUNC:SUMM:SDEV ON`  
                                   `CALC:MARK:FUNC:SUMM:SDEV:RES?`

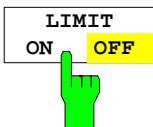

The *LIMIT ON/OFF* softkey selects the limited (*ON*) or non-limited (*OFF*) evaluation range.

The evaluation range is defined by the *START LIMIT* and *STOP LIMIT* softkeys. If *LIMIT = ON*, signals are only searched between the two lines.

If only one limit line is switched on, time line 1 is the lower limit and the upper limit corresponds to the stop frequency. If time line 2 is also switched on, it defines the upper limit.

If no limit line is switched on, the evaluation range is not limited.

The default setting is *LIMIT = OFF*.

IEC/IEEE-bus command:    `CALC:MARK:X:SLIM OFF`

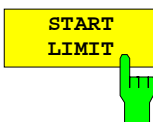

The *START LIMIT* softkey activates the entry of the lower limit of the evaluation range.

IEC/IEEE-bus command:    `CALC:MARK:X:SLIM:LEFT <value>`

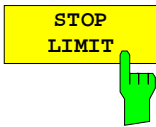

The *STOP LIMIT* softkey activates the entry of the upper limit of the evaluation range.

IEC/IEEE-bus command: `CALC:MARK:X:SLIM:RIGH <value>`

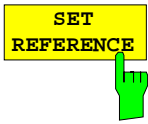

The *SET REFERENCE* softkey sets the power values currently measured as reference values for the calculation of the mean value (*MEAN*) and the rms value (*RMS*). The reference values are used to perform relative measurements.

If the calculation of the mean value (*MEAN*) and rms value (*RMS*) is not switched on, 0 dBm is used as a reference value.

If the average value (*AVERAGE*) or maximum value (*MAX HOLD*) is calculated over several sweeps, the current value is the measured value summed up at the actual time.

IEC/IEEE-bus command: `CALC:MARK:FUNC:SUMM:REF:AUTO ONCE`

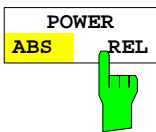

The *POWER ABS/REL* softkey selects the absolute power measurement (default setting) or relative power measurement. The reference value for the relative power is defined by *SET REFERENCE*.

The value 0 dBm is used if the reference value is not defined.

IEC/IEEE-bus command: `CALC:MARK:FUNC:SUMM:MODE ABS`

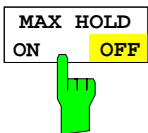

The *MAX HOLD ON/OFF* softkey switches the display of the maximum peak obtained from measurements at successive sweeps on and off.

The displayed maximum peak is only updated at the end of a sweep if a higher value has occurred.

The maximum value can be reset by switching the *MAX HOLD ON / OFF* softkey off and on again.

IEC/IEEE-bus command: `CALC:MARK:FUNC:SUMM:PHOL ON`  
`CALC:MARK:FUNC:SUMM:PPE:PHOL:RES?`  
`CALC:MARK:FUNC:SUMM:RMS:PHOL:RES?`  
`CALC:MARK:FUNC:SUMM:MEAN:PHOL:RES?`  
`CALC:MARK:FUNC:SUMM:SDEV:PHOL:RES?`

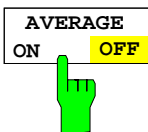

The *AVERAGE ON/OFF* softkey switches averaging over successive sweep measurements on and off.

The measured values can be reset by switching the *AVERAGE ON / OFF* softkey off and on again.

IEC/IEEE-bus command: `CALC:MARK:FUNC:SUMM:AVER ON`  
`CALC:MARK:FUNC:SUMM:PPE:AVER:RES?`  
`CALC:MARK:FUNC:SUMM:RMS:AVER:RES?`  
`CALC:MARK:FUNC:SUMM:MEAN:AVER:RES?`  
`CALC:MARK:FUNC:SUMM:SDEV:AVER:RES?`

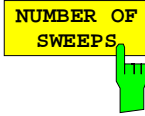

The *NUMBER OF SWEEPS* softkey activates the entry of the number of sweeps for maximum or average value calculation.

*SINGLE SWEEP* mode                      The ESPI performs sweeps until the selected number of sweeps is reached and stops then.

*CONTINUOUS SWEEP* mode              Averaging is carried out until the selected number of sweeps is reached. After that, averaging is performed in continuous mode. and is then continued as running averaging. Calculation of the maximum peak (*MAX HOLD*) is performed continuously irrespective of the selected number of sweeps.

The valid range values is 0 to 32767.

Depending on the specified number of sweeps, averaging is carried out according to the following rules:

*NUMBER OF SWEEPS* = 0              Continuous averaging is carried out over 10 measured values.

*NUMBER OF SWEEPS* = 1              No averaging is carried out.

*NUMBER OF SWEEPS* > 1              Averaging is carried out over the set number of measured values.

**Note:**                      *This setting is equivalent to the setting of the sweep count in the TRACE menu.*

IEC/IEEE-bus command:              `SWE:COUN <value>`

### Example:

The mean power of a GSM burst with 0 dBm nominal power at 800 MHz is to be measured.

[PRESET]	Set the ESPI to the default setting.
[FREQ: CENTER: 800 MHz]	Set the center frequency to 800 MHz.
[SPAN: ZERO SPAN]	Select time domain display (span = 0 Hz).
[AMPT: 0 dBm]	Set the reference level to 0 dBm.
[BW: RES BW MANUAL: 30 kHz]	Set the resolution bandwidth to 30 kHz in line with the requirements of the GSM standard.
[SWEEP: SWEEPTIME MANUAL 600 µs]	Set the sweep time to 600 µs.
[TRIG: VIDEO: 50 %]	Use the video signal as trigger source.
[MEAS]	Call the menu for the measurement functions.
[TIME DOM POWER]	Select power measurement in the time domain. The ESPI calculates the mean power from the points of the whole trace. The submenu for configuration of the power measurement is opened. <i>MEAN</i> is already switched on.
[LIMITS ON]	Activate the limitation of the time domain of the power measurement .
[START LIMIT: 250 µs]	Set the start of the power measurement at 250 µs.
[STOP LIMIT: 500 µs]	Set the end of the power measurement at 500 µs.

**Note:**                      *The GSM specifications require the power to be measured between 50% and 90% of the TDMA burst. The time limits set above approximately correspond to the required time domain.*

### Channel and Adjacent-Channel Power Measurements

For all channel and adjacent-channel power measurements a specified channel configuration is assumed which is for instance based on a specific radiocommunication system.

This configuration is defined by the nominal channel frequency (= center frequency of the ESPI), channel bandwidth, adjacent-channel bandwidth and adjacent-channel spacing. The ESPI is able to simultaneously measure the power in up to three adjacent channels (7 channels: transmission channel, 3 lower and 3 upper adjacent channels).

It offers two methods for channel and adjacent-channel power measurement:

- The integrated bandwidth method (IBW method), ie the integration of trace pixels within the bandwidth of the channel to be measured to the total power of the channel,
- The measurement in time domain (Fast ACP) by means of steep resolution filters simulating the channel.

The two measurements yield the same results. The measurement in time domain can be performed much faster since the complete signal is measured within a channel at the same time. With the IBW method, the channel is divided into subspectra. This is done by means of a bandwidth which is small compared to the channel bandwidth. These subspectra are then combined by integration of the trace pixels.

With the IBW method, the transmission channel or adjacent channels are marked by vertical lines at a distance of half the channel bandwidth to the left and to the right of the corresponding channel center frequency. (see Fig. 4-13).

In the time-domain method, the power trace in the different channels is shown. (see Fig. 4-14).

For both methods, the results are listed in tables in the lower half of the screen.

The ESPI offers predefined standard settings which can be selected from a table for the common mobile radio standards. Thus, channel configuration is performed automatically without the need to enter the corresponding parameters manually.

For some standards, the channel power and the adjacent-channel power are to be weighted by means of a root-raised cosine filter corresponding to a receive filter. This type of filtering is switched on automatically for both methods on selecting the standard (eg NADC, TETRA or 3GPP W-CDMA).

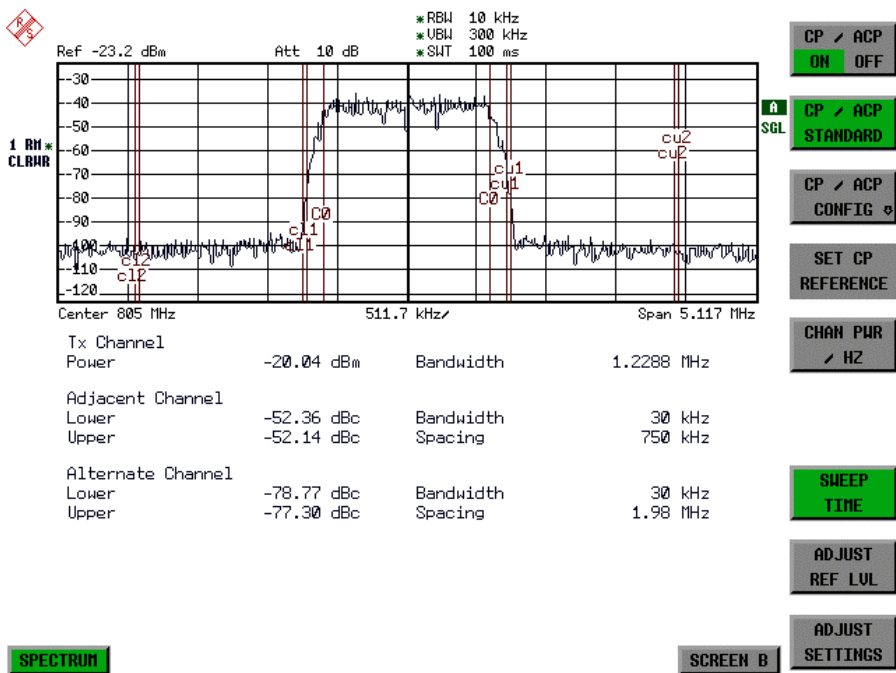

Fig. 4-13 Screen display of adjacent-channel power measurement using the IBW method

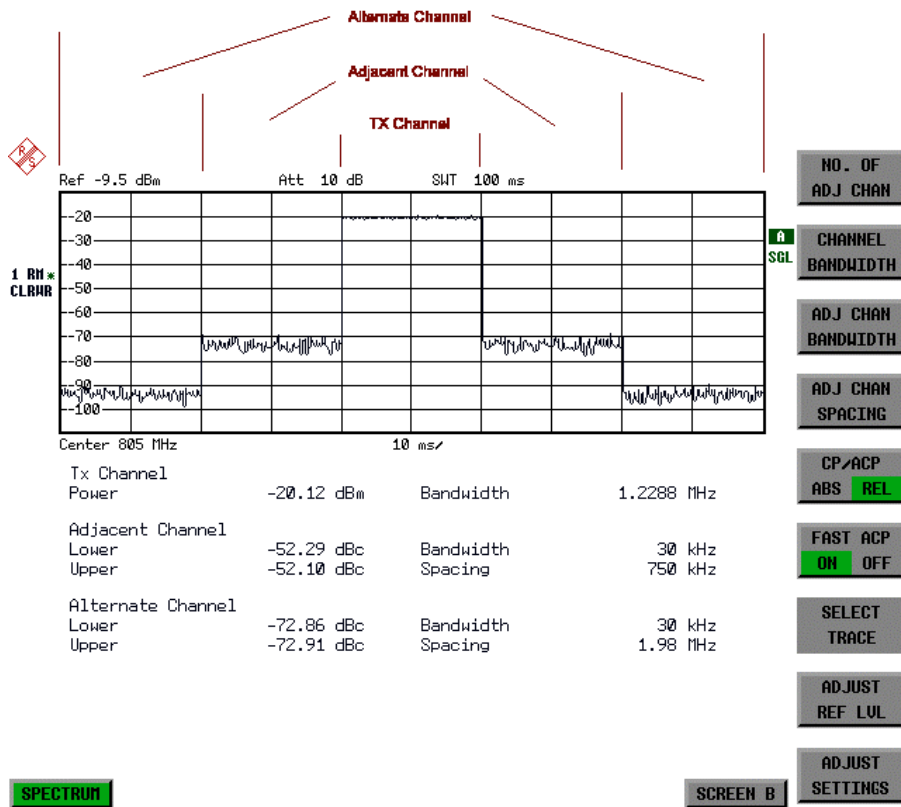
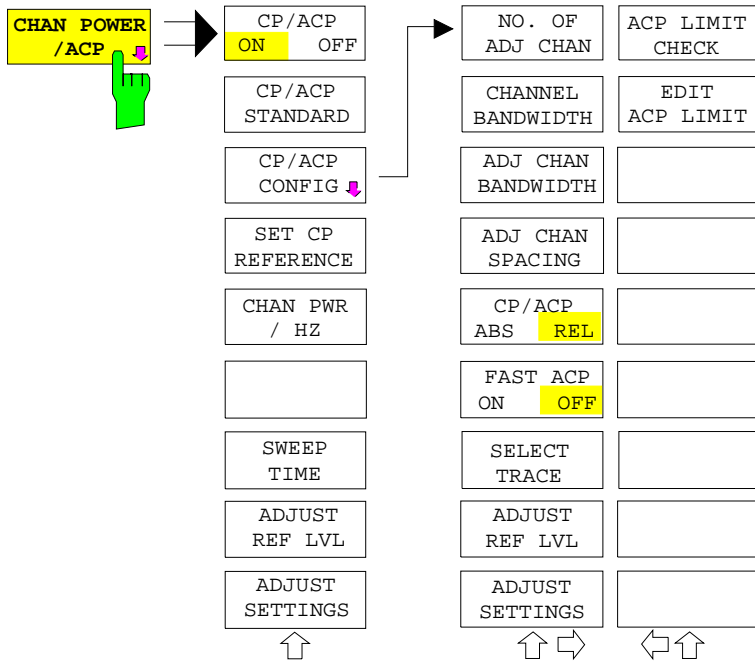

Fig. 4-14 Screen display of adjacent-channel power measurement using the time-domain method

Limit values for the adjacent-channel power can be defined for the measurement. If limit checking is switched on, a pass/fail information indicating that the power has been exceeded is displayed during the measurement in the table in the lower half of the screen.

**Note:** With the CP/ACP measurement switched on the functions SPLIT SCREEN and FULL SCREEN are inhibited.

The channel configuration is defined in the *MEAS CHAN POWER/ACP* menu.



The *CHAN POWER /ACP* softkey switches on the channel power measurement or adjacent-channel power measurement according to the current configuration. At the same time it opens the submenu for defining the channel power measurement. The softkey is highlighted to show that channel or adjacent-channel power measurement is on.

**Note:** This softkey can only be operated in frequency domain ( $SPAN > 0$ ).

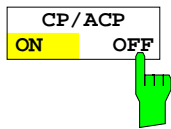

The *CP/ACP ON/OFF* softkey switches the calculation of the channel power or adjacent-channel power on or off.

With default settings the measurement is performed by integrating the powers at the display points within the specified channels (IBW method).

The adjacent-channel power can be either absolute or relative related to the transmission channel power. The default setting is relative measurement (see softkey *CP/ACP ABS/REL*).

IEC/IEEE-bus command: `CALC:MARK:FUNC:POW:SEL CPOW|ACP`  
`CALC:MARK:FUNC:POW:RES? CPOW|ACP`  
`CALC:MARK:FUNC:POW OFF`



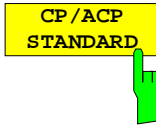

The *CP/ACP STANDARD* softkey opens a table for the selection of the settings according to predefined standards. The test parameters for the channel and adjacent-channel measurements are set according to the mobile radio standard.

ACP STANDARD
✓ NONE
NADC IS136
TETRA
PDC
PHS
CDPD
CDMA IS95A FWD
CDMA IS95A REV
CDMA IS95C Class 0 FWD
CDMA IS95C Class 0 REV
CDMA J-STD008 FWD
CDMA J-STD008 REV
CDMA IS95C Class 1 FWD
CDMA IS95C Class 1 REV
W-CDMA 4.096 FWD
W-CDMA 4.096 REV
W-CDMA 3GPP FWD
W-CDMA 3GPP REV
CDMA 2000 DS
CDMA 2000 MC1
CDMA 2000 MC3

The standards available are listed in the table on the left.

**Note:** For the ESPI, the channel spacing is defined as the distance between the center frequency of the adjacent channel and the center frequency of the transmission channel. The definition of the adjacent-channel spacing in standards IS95 B and C, IS97 B and C and IS98 B and C is different. These standards define the adjacent-channel spacing from the center of the transmission channel to the closest border of the adjacent channel. This definition is also used for the ESPI when the following standard settings are selected:  
 CDMA IS95 Class 0 FWD  
 CDMA IS95 Class 0 REV  
 CDMA IS95 Class 1 FWD  
 CDMA IS95 Class 1 REV

The selection of the standard influences the following parameters:

- channel spacing
- channel bandwidth and type of filtering
- resolution bandwidth
- video bandwidth
- detector
- # of adjacent channels

Trace mathematics and trace averaging are switched off.

The reference level is not influenced by the selection of a standard. To achieve an optimum dynamic range, the reference level has to be set in a way that places the signal maximum close to the reference level without forcing an overload message.

The default setting is *CP/ACP STANDARD NONE*.

IEC/IEEE-bus command: `CALC:MARK:FUNC:POW:PRES <standard>`

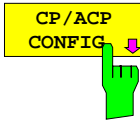

See following section "Setting the Channel Configuration"

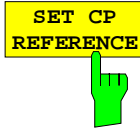

With channel power measurement activated, the *SET CP REFERENCE* softkey defines the currently measured channel power as the reference value. The reference value is displayed in the *CH PWR REF* field; the default value is 0 dBm.

During the adjacent-channel power measurement the power in the transmission channel becomes the reference value. The display *CH PWR REF* is not required.

IEC/IEEE-bus command: `POW:ACH:REF:AUTO ONCE`

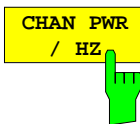

The *CHAN PWR / HZ* softkey selects the measurement of the total channel power or the measurement of the channel power referred to 1 Hz bandwidth.

The conversion factor is  $10 \cdot \lg \frac{1}{\text{Channel} \cdot \text{Bandwidth}}$ .

This function allows for instance measurement of the noise power density or, in conjunction with the *CP/ACP REL* and *SET CP REFERENCE* functions, measurement of the signal-to-noise ratio.

IEC/IEEE-bus command: `CALC:MARK:FUNC:POW:RES:PHZ ON|OFF`

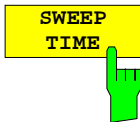

The *SWEEP TIME* softkey activates the entry of the sweep time. With the RMS detector, a longer sweep time increases the stability of the measurement results. The function of the softkey is identical to the softkey *SWEEP TIME MANUAL* in the menu *BW*.

IEC/IEEE-bus command: `SWE:TIM <value>`

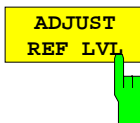

The *ADJUST REF LVL* softkey adjusts the reference level of the ESPI to the measured channel power. This ensures that the settings of the RF attenuation and the reference level are optimally adjusted to the signal level without overloading the ESPI or limiting the dynamic range by a too small S/N ratio.

Since the measurement bandwidth for channel power measurements is significantly lower than the signal bandwidth, the signal path may be overloaded although the trace is still significantly below the reference level.

IEC/IEEE-bus command: `SENS:POW:ACH:PRES:RLEV`



The *ADJUST SETTINGS* softkey automatically optimizes the instrument settings for the selected power measurement (see below).

All instrument settings relevant for a power measurement within a specific frequency range (channel bandwidth) are optimized for the selected channel configuration (channel bandwidth, channel spacing):

- Frequency span:

The frequency span has to cover at least all channels to be considered.

When measuring the channel power,  
 $2 \times \text{channel bandwidth} + \text{reserve}$   
 is set as span.

The setting of the span during adjacent-channel power measurement is dependent on the channel spacing and channel bandwidth of the adjacent channel ADJ, ALT1 or ALT2 with the largest distance from the transmission channel.

When measuring the adjacent channel power, the following is set as span  
 $2 \times (\text{channel bandwidth} + \text{channel width}) + \text{reserve}$

The measurement reserve is about 10% of the value calculated from channel spacing and channel bandwidth.

- Resolution bandwidth             $\text{RBW} \leq 1/40$  of channel bandwidth
- Video bandwidth                 $\text{VBW} \geq 3 \times \text{RBW}$
- Detector                            RMS detector

Trace math and trace averaging functions are switched off.

The reference level is not influenced by *ADJUST SETTINGS*. It can be separately adjusted with *ADJUST REF LVL*.

The adjustment is carried out only once; if necessary, the instrument settings can be changed later.

IEC/IEEE-bus command:            `SENS:POW:ACH:PRES ACP|CPOW|OBW`

For manual setting of the test parameters different from the settings made with *ADJUST SETTINGS* the following should be observed:

#### Frequency span

The frequency span has to cover at least all channels to be measured plus a measurement reserve of 10%.

For channel power measurement this is the  $1.1 \times \text{channel bandwidth}$ .

**Note:**

*If the frequency span is large compared to the channel bandwidth (or adjacent channel bandwidths), only a few pixels of the trace are available for each channel.*

*As a result, the accuracy of the waveform calculation for the used channel filters is reduced, which in turn impairs the measurement accuracy.*

*It is therefore strongly recommended to consider the above formulas when selecting the span.*

## Resolution bandwidth (RBW)

To ensure both an acceptable measurement speed and the required selection (to suppress spectral components outside the channel to be measured, especially of the adjacent channels), the resolution bandwidth must not be selected too small or too large. As a general approach, the resolution bandwidth is to be set to values between 1% and 4% of the channel bandwidth. A larger resolution bandwidth can be selected if the spectrum within the channel to be measured and around it has a flat characteristic. In the standard setting, eg for standard IS95A REV at an adjacent channel bandwidth of 30 kHz, a resolution bandwidth of 30 kHz is used. This yields correct results since the spectrum in the neighbourhood of the adjacent channels normally has a constant level. For standard NADC/IS136 this is not possible for example, since the spectrum of the transmit signal penetrates into the adjacent channels and a too large resolution bandwidth causes a too low selection of the channel filter. The adjacent-channel power would thus be measured too high.

With the exception of the IS95 CDMA standards, the *ADJUST SETTINGS* softkey sets the resolution bandwidth (RBW) as a function of the channel bandwidth:

$$\text{RBW} \leq 1/40 \text{ of channel bandwidth.}$$

The maximum possible resolution bandwidth (with respect to the requirement  $\text{RBW} \leq 1/40$ ) resulting from the available RBW steps (1, 3) is selected .

## Video bandwidth (VBW)

For a correct power measurement, the video signal must not be limited in bandwidth. A restricted bandwidth of the logarithmic video signal would cause signal averaging and thus result in a too low indication of the power (-2.51 dB at very low video bandwidths). The video bandwidth should therefore be selected at least three times the resolution bandwidth.

The *ADJUST SETTINGS* softkey sets the video bandwidth (VBW) as a function of the channel bandwidth as follows:

$$\text{VBW} \geq 3 \times \text{RBW.}$$

The smallest possible VBW with regard to the available step size will be selected.

## Detector

The *ADJUST SETTINGS* softkey selects the RMS detector.

The RMS detector is selected since it correctly indicates the power irrespective of the characteristics of the signal to be measured. In principle, the sample detector would be possible as well. Due to the limited number of trace pixels used to calculate the power in the channel, the sample detector would yield less stable results. Averaging, which is often performed to stabilize the measurement results, leads to a too low level indication and should therefore be avoided. The reduction in the displayed power depends on the number of averages and the signal characteristics in the channel to be measured.

## Setting the Channel Configuration

MEAS - CP/ACP CONFIG submenu:

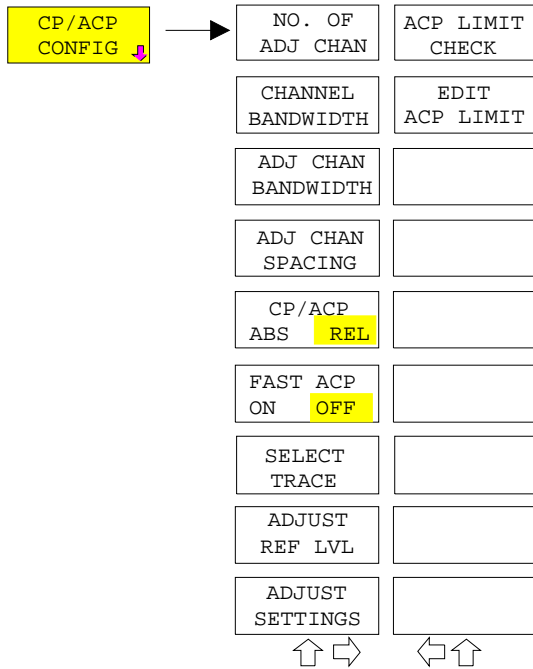

The *CP/ACP CONFIG* softkey opens a submenu for configuration of the channel power and adjacent channel power measurement independent from the offered standards.

The channel configuration consists of the number of adjacent channels to be measured, the channel bandwidth (*CHANNEL BANDWIDTH*), the bandwidth of the adjacent channels (*ADJ CHANNEL BANDWIDTH*) and the distance of the adjacent channels from the center frequency of the transmission channel (*ADJ CHANNEL SPACING*).

Limit values can additionally be specified for the adjacent-channel power (*ACP LIMIT CHECK* and *EDIT ACP LIMITS*) which are checked for compliance during the measurement.

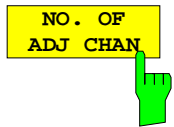

The *NO. OF ADJ CHAN* softkey activates the entry of the number  $\pm n$  of adjacent channels to be considered in the adjacent-channel power measurement. Numbers from 0 to 3 can be entered.

The following measurements are performed depending on the number of the channels.

- 0 Only the channel power is measured.
- 1 The channel power and the power of the upper and lower adjacent channel are measured.
- 2 The channel power, the power of the upper and lower adjacent channel and of the next higher and lower channel (alternate channel 1) are measured.
- 3 The channel power, the power of the upper and lower adjacent channel, the power of the next higher and lower channel (alternate channel 1) and of the next but one higher and lower adjacent channel (alternate channel 2) are measured.

IEC/IEEE-bus command: POW:ACH:ACP 1

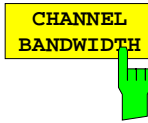

The *CHANNEL BANDWIDTH* softkey activates the entry of the channel bandwidth for the transmission channel.

The useful channel bandwidth is generally defined by the transmission method. It is automatically adjusted correctly on measurements according to a given standard (see *CP/ACP STANDARD* softkey).

When measuring according to the IBW method (*FAST ACP OFF*) the channel bandwidth is displayed by two vertical lines to the left and right of the screen center. It can thus be visually checked whether the whole power of the signal to be measured is within the selected channel bandwidth.

With the time domain method (*FAST ACP ON*) the measurement is performed in zero span. The channel limits are not marked in this case. The ESPI offers all available channel filters for selection of the channel bandwidth. Deviating channel bandwidths cannot be set. If deviating channel bandwidths are required, the IBW method should be used.

The list of available channel filters is included in section "Setting of Bandwidths and Sweep Time – *BW key*".

The default setting is 14 kHz.

IEC/IEEE-bus command:            SENS:POW:ACH:BWID 14kHz



The *ADJ CHAN BANDWIDTH* softkey opens a table for defining the channel bandwidths for the adjacent channels.

ACP CHANNEL BW	
CHAN	BANDWIDTH
ADJ	14 kHz
ALT1	14 kHz
ALT2	14 kHz

When measuring according to the IBW method (*FAST ACP OFF*) the bandwidths of the different adjacent channels are to be entered numerically. Since all adjacent channels often have the same bandwidth, the other channels Alt1 and Alt2 are set to the bandwidth of the adjacent channel on entering the adjacent-channel bandwidth (ADJ). Thus only one value needs to be entered in case of equal adjacent channel bandwidths. The same holds true for the ALT2 channels (alternate channels 2) when the bandwidth of the ALT1 channel (alternate channel 1) is entered.

**Note:**     *The bandwidths can be selected independent from each other by overwriting the table from top to bottom.*

With the time domain method (*FAST ACP ON*), the adjacent-channel bandwidths are selected from the list of available channel filters. For deviating adjacent-channel bandwidths the IBW method should be used.

IEC/IEEE-bus command: SENS:POW:ACH:BWID:ACH 1kHz  
    SENS:POW:ACH:BWID:ALT1 14kHz  
    SENS:POW:ACH:BWID:ALT2 14kHz

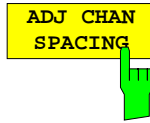

The ADJ CHAN SPACING softkey opens a table for defining the channel spacings.

ACP CHANNEL SPACING	
CHAN	SPACING
ADJ	20 kHz
ALT1	40 kHz
ALT2	60 kHz

Since all the adjacent channels often have the same distance to each other, the entry of the adjacent-channel spacing (ADJ) causes channel spacing ALT1 to be set to twice and channel spacing ALT2 to three times the adjacent-channel spacing. Thus only one value needs to be entered in case of equal channel spacing. The same holds true for the ALT2 channels when the bandwidth of the ALT1 channel is entered.

**Note:** The channel spacings can be set separately by overwriting the table from top to bottom.

IEC/IEEE-bus command: SENS:POW:ACH:SPAC:ACH 20kHz  
 SENS:POW:ACH:SPAC:ALT1 40kHz  
 SENS:POW:ACH:SPAC:ALT2 60kHz

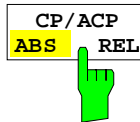

The CP/ACP ABS/REL softkey (channel power absolute/relative) switches between absolute and relative power measurement in the channel.

**CP/ACP ABS** The absolute power in the transmission channel and in the adjacent channels is displayed in the unit of the Y axis, eg in dBm, dBμV.

**CP/ACP REL** In case of adjacent-channel power measurement (NO. OF ADJ CHAN > 0) the level of the adjacent channels is displayed relative to the level of the transmission channel in dBc.

In case of channel power measurement (NO. OF ADJ CHAN = 0) the power of a transmission channel is displayed relative to the power of a reference channel defined by SET CP REFERENCE. This means:

1. Declare the power of the currently measured channel as the reference value, using the SET CP REFERENCE softkey.
2. Select the channel of interest by varying the channel frequency (ESPI center frequency).

With linear scaling of the Y axis, the power of the new channel relative to the reference channel (CP/CP<sub>ref</sub>) is displayed. With dB scaling, the logarithmic ratio 10lg (CP/CP<sub>ref</sub>) is displayed.

The relative channel power measurement can thus also be used for universal adjacent-channel power measurements. Each channel can be measured individually.

IEC/IEEE-bus command: SENS:POW:ACH:MODE ABS

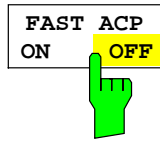

The *FAST ACP* softkey switches between the IBW method (*FAST ACP OFF*) and the time domain method (*FAST ACP ON*).

With *FAST ACP ON* the power measurement is performed in the different channels in time domain. The ESPI sets the center frequency consecutively to the different channel center frequencies and measures the power with the selected measurement time (= sweep time/number of channels). The RBW filter suitable for the selected standard and frequency offset are automatically used (eg root raised cos with IS 136). The list of available channel filters is included in section "Setting of Bandwidths and Sweep Time – *BW key*".

The RMS detector is used for obtaining correct power measurement results. Therefore this requires no software correction factors.

The measured values are displayed in a table, the power in the useful channel being displayed in dBm and the power in the adjacent channels in dBm (CP/ACP ABS) or dB (CP/ACP REL).

The sweep time is selected depending on the desired reproducibility of results. Reproducibility increases with sweep time since power measurement is then performed over a longer time period.

As a general approach, it can be assumed that approx. 500 non-correlated measured values are required for a reproducibility of 0.5 dB (99% of the measurements are within 0.5 dB of the true measured value). This holds true for white noise. The measured values are considered as non-correlated when their time interval corresponds to the reciprocal of the measured bandwidth.

With IS 136 the measurement bandwidth is approx. 25 kHz, ie measured values at an interval of 40 µs are considered as non-correlated. A measurement time of 20 ms is thus required per channel for 1000 measured values. This is the default sweep time which the ESPI sets in coupled mode. Approx. 5000 measured values are required for a reproducibility of 0.1 dB (99%), ie the measurement time is to be increased to 200 ms.

IEC/IEEE-bus command                      SENS:POW:HSP ON

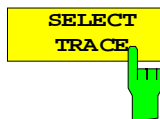

The *SELECT TRACE* softkey selects the trace, on which the CP/ACP measurement is performed. Only traces can be selected, which are switched on (= not set to BLANK).

IEC/IEEE-bus command:                      SENS:POW:TRAC 1

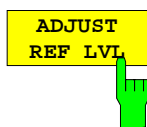

See main menu *CHAN PWR ACP*.

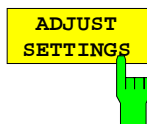

See main menu *CHAN PWR ACP*.



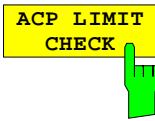

The *ACP LIMIT CHECK* softkey switches the limit check for the ACP measurement on and off.

IEC/IEEE-bus command:   
 CALC:LIM:ACP ON   
 CALC:LIM:ACP:ACH:RES?   
 CALC:LIM:ACP:ALT:RES?

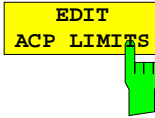

The *EDIT ACP LIMITS* softkey opens a table for defining the limits for the ACP measurement.

ACP LIMITS				
CHAN	RELATIVE LIMIT CHECK		ABSOLUTE LIMIT CHECK	
	VALUE	ON	VALUE	ON
ADJ	-45 dB	✓		
ALT1	-60 dB	✓		
ALT2				

The following rules apply for the limits:

- A separate limit can be defined for each adjacent channel. The limit applies to both the upper and the lower adjacent channel.
- A relative and/or absolute limit can be defined. The check of both limit values can be activated independently.
- The ESPI checks adherence to the limits irrespective of whether the limits are absolute or relative or whether the measurement is carried out with absolute or relative levels. If both limits are active and if the higher of both limit values is exceeded, the measured value is marked accordingly.

**Note:** *Measured values exceeding the limit are marked by a preceding asterisk.*

IEC/IEEE-bus command:   
 CALC:LIM:ACP ON   
 CALC:LIM:ACP:ACH 0dB,0dB   
 CALC:LIM:ACP:ACH:STAT ON   
 CALC:LIM:ACP:ACH:ABS -10dBm,-10dBm   
 CALC:LIM:ACP:ACH:ABS:STAT ON   
 CALC:LIM:ACP:ALT1 0dB,0dB   
 CALC:LIM:ACP:ALT1:STAT ON   
 CALC:LIM:ACP:ALT1:ABS -10dBm,-10dBm   
 CALC:LIM:ACP:ALT1:ABS:STAT ON   
 CALC:LIM:ACP:ALT2 0dB,0dB   
 CALC:LIM:ACP:ALT2:STAT ON   
 CALC:LIM:ACP:ALT2:ABS -10dBm,-10dBm   
 CALC:LIM:ACP:ALT2:ABS:STAT ON

**Examples:****1. Measurement of adjacent-channel power for a specific standard:**

The adjacent-channel power is to be measured for a signal at 800 MHz with 0 dBm level in line with IS136.

[PRESET]	Set the ESPI to the default setting.
[FREQ: CENTER: 800 MHz]	Set the center frequency to 800 MHz.
[AMPT: 0 dBm]	Set the reference level to 0 dBm.
[MEAS]	Call the menu for the measurement functions.
[CHAN PWR / ACP]	Select the channel and adjacent-channel power measurement function. The measurement is performed with the default settings or a previously defined setting. The submenu for setting the desired new configuration is opened.
[CP/ACP STANDARD: select IS136: ENTER]	Select the NADC (IS136) standard.
[CP/ACP CONFIG]	Call the submenu for configuration of the adjacent-channel power measurement.
[NO. OF ADJ CHAN: 2 ENTER]	Select two adjacent channels for the measurement, ie the adjacent channel and the alternate channel are measured.
	Change to the main menu for channel power measurement.
[ADJUST SETTINGS]	Set the optimum span, resolution bandwidth (RBW), video bandwidth (VBW) and detector automatically for the measurement. The absolute channel power and the relative power of the adjacent channels are displayed on the screen.
[ADJUST REF LVL]	Set the reference level equal to the channel power measured.

## 2. Measurement with user-specific channel configuration:

Measurement of the adjacent-channel power ratio (ACPR) of an IS95 CDMA signal at 800 MHz, level 0 dBm. Similar to example 1, the setting can be simplified by using *CP/ACP STANDARD*.

[PRESET] Set the ESPI to the default setting.

[FREQ: CENTER: 800 MHz] Set the center frequency to 800 MHz.

[AMPT: 0 dBm] Set the reference level to 0 dBm.

[MEAS] Call the menu for the measurement functions.

[CHAN PWR / ACP] Select the channel and adjacent-channel power measurement function. The measurement is carried out with the default settings or a previously defined setting. The submenu for setting the desired new configuration is opened.

[CP/ACP CONFIG] Call the submenu for defining the channel configuration.

[NO. OF ADJ CHAN:  
2 ENTER] Select two adjacent channels for the measurement, ie the adjacent channel and the alternate channel are measured.

[CHANNEL BANDWIDTH:  
1.23 MHz] Set the channel bandwidth to 1.23 MHz according to IS95.

[ADJ CHAN BANDWIDTH:  
30 kHz] Open the list for setting the bandwidth of the adjacent channels.

ACP CHANNEL BW	
CHAN	BANDWIDTH
ADJ	30 kHz
ALT1	30 kHz
ALT2	30 kHz

Upon entry of 30 kHz for the adjacent channel the alternate channels are also set to 30 kHz.

[ADJ CHAN SPACING:

885 kHz:  : 1.98 MHz]

Open the list for entering the adjacent-channel spacings.

ACP CHANNEL SPACING	
CHAN	SPACING
ADJ	885 kHz
ALT1	1.98 MHz
ALT2	2.97 MHz

Upon entry of 885 kHz for the adjacent channel the channels ALT1 and ALT2 are set to 1770 kHz and 2655 kHz. Upon entry of 1.98 MHz for the alternate channel 1 the alternate channel 2 is set to 2.97 MHz.

PREV

In dasHauptmenü für die Kanalleistungsmessung wechseln.

[ADJUST SETTINGS] Automatically set the optimum span (= 5 MHz), resolution bandwidth (RBW = 30 kHz), video bandwidth (VBW = 300 kHz) and detector (RMS) for the measurement. The absolute channel power and the relative power of the adjacent channels and alternate channels are displayed on the screen.

[ADJUST REF LVL] Set the reference level equal to the channel power measured.

### 3. Measurement of signal/noise power density (C/No) of an IS95 CDMA signal (frequency 800 MHz, level 0 dBm)

[PRESET]	Set the ESPI to the default setting.
[FREQ: CENTER: 800 MHz]	Set the center frequency to 800 MHz.
[AMPT: 0 dBm]	Set the reference level to 0 dBm.
MEAS]	Call the menu for the measurement functions.
[CHAN PWR / ACP]	Select the channel and adjacent-channel power measurement. The measurement is performed with the default setting or a previously defined setting. The submenu for setting the desired new configuration is opened.
[CP/ACP CONFIG]	Call the submenu for defining the channel configuration.
[NO. OF ADJ CHAN: 0 ENTER]	Do not select an adjacent channel for the measurement, ie the measurement is carried out in one channel only.
[CHANNEL BANDWIDTH: 1.23 MHz]	Set the channel bandwidth to 1.23 MHz in line with IS95.
	Change to the main menu for channel power measurement
[ADJUST SETTINGS]	Set the optimum span (= 5 MHz), resolution bandwidth (RBW = 30 kHz), video bandwidth (VBW = 300 kHz) and detector (RMS) for the measurement automatically. The absolute channel power and the relative power of the adjacent channels and alternate channels are displayed on the screen.
[ADJUST REF LVL]	Set the reference level equal to the channel power measured.
[SET CP REFERENCE]	Set the measured channel power as a reference for the subsequent measurements.
[CP/ACP ABS / REL]	Select relative measurement related to the reference power set with SET REFERENCE (result 0 dB).
[CHAN PWR / HZ]	Select power measurement related to 1 Hz bandwidth (result -60.9 dB).
[FREQ: CENTER: 805 MHz]	Set the center frequency to 805 MHz. The ESPI measures the channel power at 1.23 MHz bandwidth and outputs the result in dB relative to the reference power and 1 Hz bandwidth.

## Measurement of Occupied Bandwidth

An important characteristics of a modulated signal is its occupied bandwidth. In a radio communications system for instance the occupied bandwidth must be limited to enable distortion-free transmission in adjacent channels. The occupied bandwidth is defined as the bandwidth containing a defined percentage of the total transmitted power. A percentage between 10% and 99.9% can be set on the ESPI.

MEAS OCCUPIED BANDWIDTH menu:

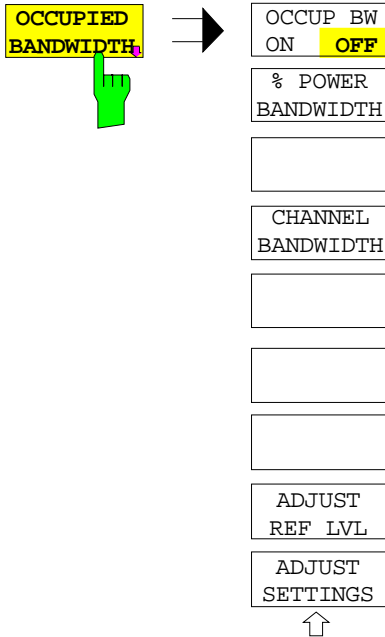

The *OCCUPIED BANDWIDTH* softkey activates measurement of the occupied bandwidth according to the current configuration and opens the submenu for configuring the measurement. The softkey is available only in frequency domain ( $span > 0$ ) and is highlighted when the measurement is switched on.

In the spectrum display mode, this measurement determines the bandwidth that contains a predefined percentage of the power of the displayed frequency range (*% POWER BANDWIDTH* softkey). The occupied bandwidth is output in the marker display field and marked on the trace by temporary markers.

- Note:**
- The softkey is only available in frequency domain ( $span > 0$ ).
  - The measurement is performed on the trace with marker 1. In order to evaluate another trace, marker 1 must be placed on another trace by means of *SELECT TRACE* in the *MKR* menu

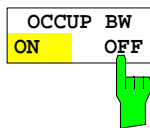

The *OCCUP BW ON/OFF* softkey switches measurement of the occupied bandwidth on or off.

IEC/IEEE-bus command:

```
CALC:MARK:FUNC:POW:SEL:OBW
CALC:MARK:FUNC:POW:RES? OBW
CALC:MARK:FUNC:POW:OFF
```

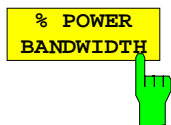

The *% POWER BANDWIDTH* softkey opens the entry of the percentage of power related to the total power in the displayed frequency range which defines the occupied bandwidth (percentage of total power). The valid range of values is 10% to 99.9%.

IEC/IEEE-bus command:

```
SENS:POW:BWID 99PCT
```



The *CHANNEL BANDWIDTH* softkey opens an input window for defining the channel bandwidth for the transmission channel. For measurements in line with a specific transmission standard, the bandwidth specified by the standard for the transmission channel must be entered.

The default setting is 14 kHz.

The specified channel bandwidth is used for optimization of the test parameters of the ESPI with *ADJUST SETTINGS*.

IEC/IEEE-bus command:            `SENS:POW:ACH:BWID 14kHz`

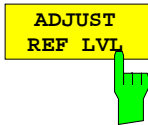

The *ADJUST REF LVL* softkey adjusts the reference level of the ESPI to the measured total power of the signal. The softkey is activated after the first sweep with the measurement of the occupied bandwidth has been completed and the total power of the signal is thus known.

Adjusting the reference level ensures that the signal path of the ESPI will not be overloaded and the dynamic range not limited by too low a reference level.

Since the measurement bandwidth for channel power measurements is significantly lower than the signal bandwidth, the signal path may be overloaded although the trace is distinctly below the reference level. If the measured channel power is equal to the reference level, the signal path cannot be overloaded.

IEC/IEEE-bus command:            `SENS:POW:ACH:PRES:RLEV`

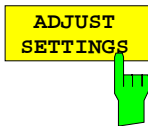

The *ADJUST SETTINGS* softkey optimizes the instrument settings for the measurement of the occupied bandwidth according to the specified channel bandwidth.

All instrument settings relevant for power measurement within a specific frequency range, such as

- frequency span                    3 x channel bandwidth
- resolution bandwidth             $RBW \leq 1/40$  of channel bandwidth
- video bandwidth                  $VBW \geq 3 \times RBW$
- detector                            RMS

are optimized.

The reference level is not influenced by *ADJUST SETTINGS*. For an optimum dynamic range it should be selected in a way that the signal maximum is close to the reference level.

The adjustment is carried out only once; if necessary, the instrument settings may be changed later.

IEC/IEEE-bus command:            `SENS:POW:PRES OBW`

## Measurement principle:

For example, the bandwidth containing 99% of the signal power is to be determined. The routine first calculates the total power of all displayed points of the trace. In the next step, the points from the right edge of the trace are summed up until 0.5% of the total power is reached. Auxiliary marker 1 is positioned at the corresponding frequency. Then the ESPI sums up the points from the left edge of the trace until 0.5% of the power is reached. Auxiliary marker 2 is positioned at this point. 99% of the power is now between the two markers. The distance between the two frequency markers is the occupied bandwidth which is displayed in the marker info field.

A prerequisite for correct measurement is that only the signal to be measured is visible on the screen of the ESPI. An additional signal would invalidate the measurement.

To ensure correct power measurement especially for noise signals and to obtain the correct occupied bandwidth, the following settings should be selected:

RBW	<< occupied bandwidth (approx. 1/20 of occupied bandwidth, for voice communication type. 300 Hz or 1 kHz)
VBW	$\geq 3 \times$ RBW
Detector	RMS or sample
Span	$\geq 2$ to $3 \times$ occupied bandwidth

Some of the measurement specifications (eg PDC, RCR STD-27B) require measurement of the occupied bandwidth using a peak detector. The detector setting of the ESPI has to be changed accordingly then.

### Example:

Measurement of occupied bandwidth of a PDC signal at 800 MHz, level 0 dBm

[PRESET]	Set the ESPI to the default setting.
[FREQ: CENTER: 800 MHz]	Set the center frequency to 800 MHz.
[AMPT: 0 dBm]	Set the reference level to 0 dBm.
[MEAS]	Call the menu for the measurement functions.
[OCCUPIED BANDWIDTH]	Select measurement of the occupied bandwidth and open the submenu for configuring the measurement.
[% POWER BANDWIDTH: 99 %]	Select 99% for the bandwidth to be measured.
[CHANNEL BANDWIDTH: 21 kHz]	Enter the channel bandwidth of 21 kHz specified by PDC.
[ADJUST SETTINGS]	Optimize the measurement parameters for the specified channel bandwidth.  Allow for a complete frequency sweep so that the ESPI can determine the total signal power.
[ADJUST REF LVL]	Adjust the reference level to the measured signal power.
[TRACE: DETECTOR: DETECTOR MAX PEAK]	PDC requires measurement of the occupied bandwidth using a peak detector. Therefore, switch on the peak detector instead of the RMS detector selected by <i>ADJUST SETTINGS</i> .

### Measurement of Signal Amplitude Statistics

Digital modulated signals are similar to white noise within the transmit channel, but are different in their amplitude distribution. In order to transmit the modulated signal without distortion all amplitudes of the signal have to be transmitted linearly, e. g. from the output power amplifier. Most critical are the peak amplitude values, of course.

Degradation in transmit quality caused by a transmitter two port network is dependent on the amplitude of the peak values as well as on their probability.

The probability of amplitude values can be measured with the APD function (Amplitude Probability Distribution). During a selectable measurement time all occurring amplitude values are assigned to an amplitude range. The number of amplitude values in the specific ranges is counted and the result is displayed as a histogram. Each bar of the histogram represents the percentage of measured amplitudes within the specific amplitude range.

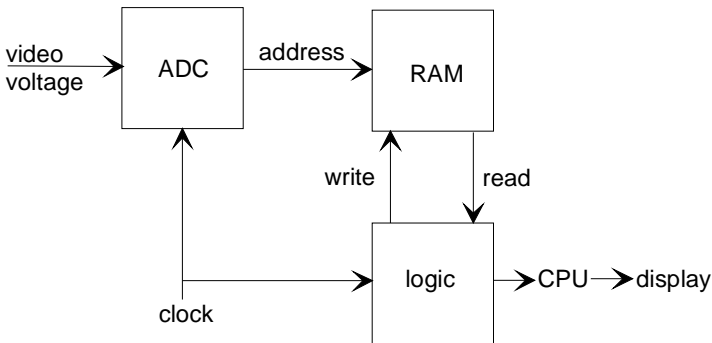

Fig. 4-15 Simplified block diagram for APD measurement

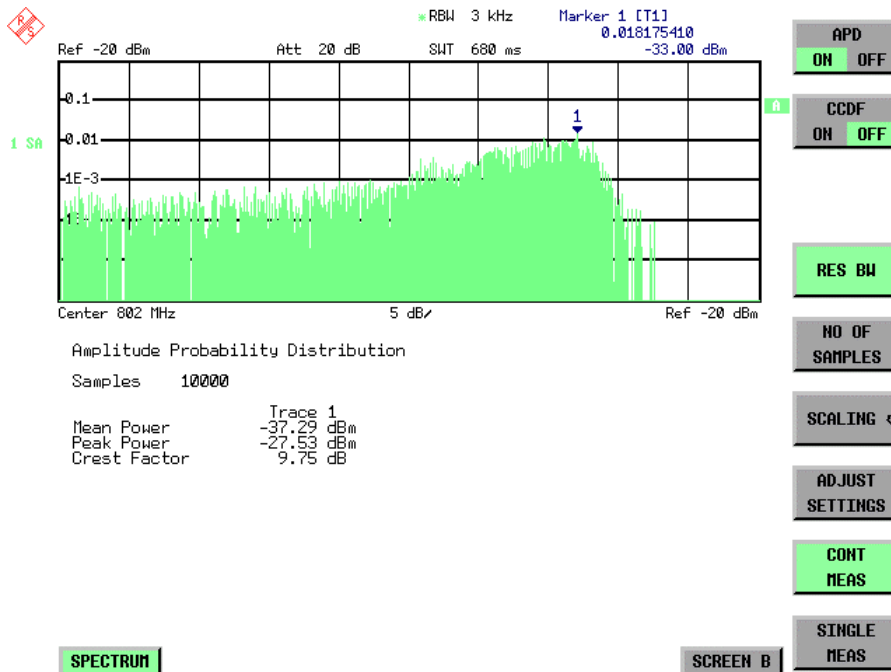

Fig. 4-16 Display of the amplitude probability distribution



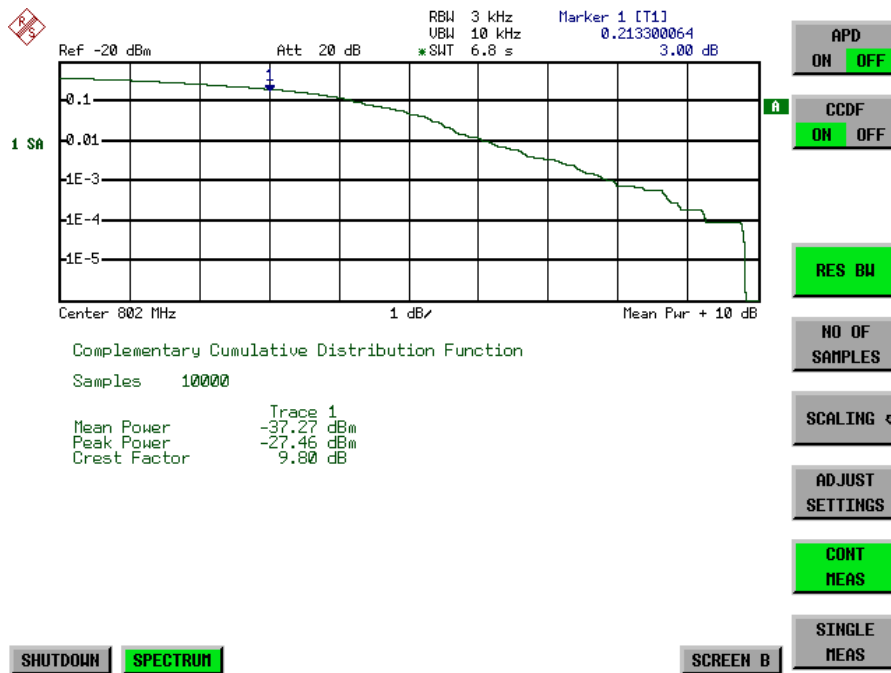

Fig. 4-17 Display of the complementary cumulative distribution function (CCDF)

Alternate to the histogram display of the APD the Complementary Cumulative Distribution Function (CCDF) can be displayed. It shows the probability of an amplitude exceeding a specific value. For the APD function the x-axis is scaled in absolute values in dBm, whereas for the CCDF function the x-axis is scaled relative to the MEAN POWER measured.

Definitions:

Crest Factor = Peak Voltage to rms

CCDF: Complementary Cumulative Distribution Function

**Note:** During an active statistic measurement the functions FULL SCREEN, SPLIT SCREEN and selection of the active diagram via SCREEN A / SCREEN B are disabled.

MEAS SIGNAL STATISTIC submenu :

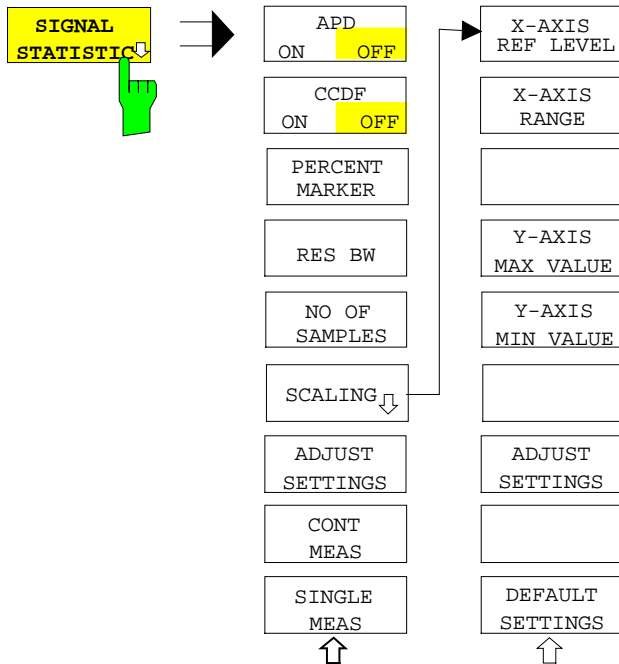

The *SIGNAL STATISTIC* softkey opens a submenu for measurement of signal statistics.

In the submenu measurement of amplitude probability density (*APD*) and complementary cumulative distribution (*CCDF*) can be selected alternately. Only one of the signal statistic functions can be switched on at a time.

In default mode all statistic functions are switched off.

With a statistic function switched on the ESPI is set into zero span mode automatically.

The ESPI measures the statistics of the signal applied to the RF input with the resolution bandwidth set. In order not to influence the peak amplitudes the video bandwidth is automatically set to 10 times the resolution bandwidth. The sample detector is used for detecting the video voltage.

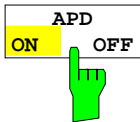

The *APD ON/OFF* softkey switches on or off the amplitude probability distribution function.

When the *APD* function is switched on, the *CCDF* function is switched off automatically.

IEC/IEEE-bus command:            `CALC:STAT:APD ON`

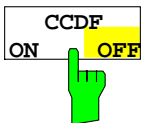

The *CCDF ON/OFF* softkey switches on or off the complementary cumulative distribution function.

When the *CCDF* function is switched on, the *APD* function is switched off automatically.

IEC/IEEE-bus command:            `CALC:STAT:CCDF ON`



If the *CCDF* function is active, the *PERCENT MARKER* softkey allows to position marker 1 by entering a probability value. Thus, the power which is exceeded with a given probability can be determined very easily.

If marker 1 is in the switched-off state, it will be switched on automatically.

IEC/IEEE-bus command:            `CALC:MARK:Y:PERC 0...100%`

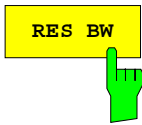

The *RES BW* softkey sets the resolution bandwidth in the menu *STATISTIC FUNCTION* directly without switching to the corresponding menu (BW). The function of the softkey is identical to the softkey *RES BW MANUAL* in the menu *BW*.

For correct measurement of the signal statistics the resolution bandwidth has to be wider than the signal bandwidth in order to transmit the actual peaks of the signal amplitude correctly. Video bandwidth is set to 10 MHz automatically with a statistic function switched on.

IEC/IEEE-bus command: `BAND 3 MHz`

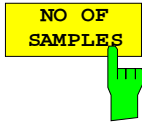

The *NO OF SAMPLES* softkey sets the number of power measurements taken into account for the statistics.

Please note that the overall measurement time is influenced by the number of samples selected as well as by the resolution bandwidth set up for the measurement as the resolution bandwidth directly influences the sampling rate.

IEC/IEEE-bus command: `CALC:STAT:NSAM <value>`

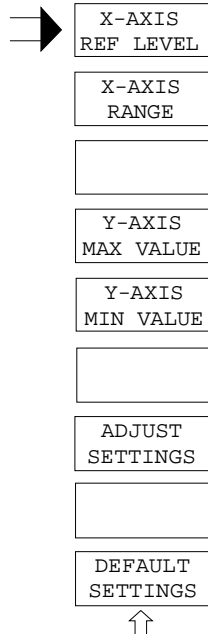
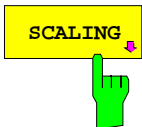

The *SCALING* softkey opens a sub menu that allows changing the scaling parameters for both the x- and the y-axis.

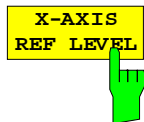

The *X-AXIS REF LEVEL* softkey changes the level settings of the instrument and sets the maximum power to be measured.

The function is identical to softkey *REF LEVEL* in menu *AMPT*. For the *APD* function this value is mapped to the right diagram border. For the *CCDF* function there is no direct representation of this value on the diagram as the x-axis is scaled relatively to the *MEAN POWER* measured.

IEC/IEEE command: `CALC:STAT:SCAL:X:RLEV <value>`

X-AXIS  
RANGE



The *X-AXIS RANGE* softkey changes the level range to be covered by the statistics measurement selected. The function is identical to softkey *RANGE LOG MANUAL* in menu *AMPT*.

IEC/IEEE command: `CALC:STAT:SCAL:X:RANG <value>`

Y-AXIS  
MAX VALUE



The *Y-AXIS MAX VALUE* softkey defines the upper limit of the displayed probability range. Values on the y-axis are normalized which means that the maximum value is 1.0. As the y-axis scaling has a logarithmic axis the distance between max and min value must be at least one decade.

IEC/IEEE command: `CALC:STAT:SCAL:Y:UPP <value>`

Y-AXIS  
MIN VALUE



The *Y-AXIS MIN VALUE* softkey defines the lower limit of the displayed probability range. As the y-axis scaling has a logarithmic axis the distance between max and min value must be at least one decade. Valid values are in the range  $0 < \text{value} < 1$ .

IEC/IEEE command: `CALC:STAT:SCAL:Y:LOW <value>`

ADJUST  
SETTINGS



see below

DEFAULT  
SETTINGS



The *DEFAULT SETTINGS* softkey resets the x- and y-axis scalings to their PRESET values.

x-axis ref level:           -20 dBm  
x-axis range APD:         100 dB  
x-axis range CCDF:        20 dB

y-axis upper limit:        1.0  
y-axis lower limit:        1E-6

IEC/IEEE-bus command:    `CALC:STAT:SCAL:PRES`

ADJUST  
SETTINGS



The *ADJUST SETTINGS* softkey optimizes the level settings of the ESPI according to the measured peak power in order to gain maximum sensitivity of the instrument.

The level range is adjusted according to the measured difference between peak and minimum power for APD measurement and peak and mean power for CCDF measurement in order to obtain maximum power resolution. Additionally the probability scale is adapted to the selected number of samples.

IEC/IEEE-bus command: `CALC:STAT:SCAL:AUTO ONCE`

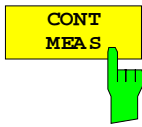

The *CONT MEAS* softkey starts collecting a new sequence of sample data and calculating the APD or CCDF curve depending on the selected measurement. The next measurement is started automatically as soon as the indicated number of samples has been reached ("CONTinuous MEASurement").

IEC/IEEE-bus command:       INIT:CONT ON;  
                                  INIT:IMM

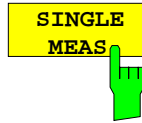

The *SINGLE MEAS* softkey starts collecting a new sequence of sample data and calculating the APD or CCDF curve depending on the selected measurement. At the beginning of the measurement previously obtained measurement results are discarded.

IEC/IEEE-bus command:       INIT:CONT OFF;  
                                  INIT:IMM

#### Hint for usage of the marker functions with measurement of signal statistics:

With the signal statistic measurement level always is displayed on x-axis. Y-axis always is a normalized value between 0 and 1. In contrary to use of marker in frequency or time domain marker is input in level values and the output is in percentage values.

#### Example:

Measurement of CCDF of a IS95 BTS signal, level 0 dBm, frequency 800 MHz

[PRESET]	Switch on preset settings.
[FREQ: CENTER: 800 MHz]	Set center frequency to 800 MHz.
[AMPT: 10 dBm]	Set reference level to 10 dBm.
[BW: 3 MHz]	Set resolution bandwidth to 3 MHz (resolution bandwidth shall be wider then signal bandwidth (1.25 MHz) in order to have the complete signal within the resolution bandwidth).
[MEAS]	Call the menu for measurement functions.
[SIGNAL STATISTIC]	Call the menu for signal statistics measurement.
[CCDF ON/OFF]	Switch on measurement of the complementary cumulative distribution function. The ESPI switches to zero span mode. The power of the signal and the CCDF is calculated for the number of samples selected. With the CCDF function sample detector and video bandwidth are set automatically.
[NO OF SAMPLES: 10000]	Set the number of measurement samples to 10000.
[SINGLE MEAS]	Start the measurement sequence. At the end the resulting trace will display the CCDF for the measured 10000 samples.

## Signal / Noise Power Measurement

With the aid of the measurement function "Carrier to Noise" the ESPI determines the signal-to-noise ratio either without ( $C/N$ ) or with reference to a 1 Hz bandwidth ( $C/N_0$ ).

To determine the noise power the measurement channel at the selected center frequency is considered and its bandwidth is set using the *CHANNEL BANDWIDTH* softkey.

The peak value of the signal within the display range is defined as carrier frequency and is marked by the *REFERENCE FIXED* marker after switching on the "Carrier to Noise" measurement. The noise power determined in the measurement channel is then subtracted from this signal level ( $C/N$ ) and referred to 1 Hz bandwidth ( $C/N_0$ ).

Signal / noise power measurements are basically performed using two methods:

1. The carrier is located inside the measurement channel:  
 In this case, it is sufficient to switch on the desired measurement and set the channel bandwidth. The signal-to-noise ratio is indicated on the display.
2. The carrier is located outside the measurement channel:  
 The measurement must be performed in two steps.  
 First, a reference measurement with an active carrier is performed. To this end, the  $C/N$  or  $C/N_0$  measurement is switched on and a first measurement is carried out.  
 Next, the carrier is switched off so that only the noise is active in the measurement channel and a second measurement is carried out. After the second measurement the signal-to-noise ratio is indicated on the display.

The selection of a suitable span for the given channel bandwidth is simplified by the *ADJUST SETTINGS* function. This function automatically sets the span to approx.  $4 * \text{channel bandwidth}$ .

On switching on the power measurement the RMS detector is activated (*TRACE-DETECTOR-RMS*).

MEAS –  $C/N$ ,  $C/N_0$  submenu:

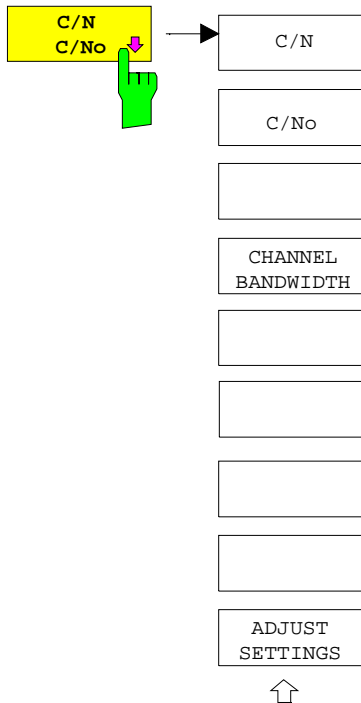

The  $C/N$ ,  $C/N_0$  softkeys open the submenu for the configuration of the  $C/N$  measurements.

Measurements without ( $C/N$ ) or with reference to a 1 Hz bandwidth ( $C/N_0$ ) can be selected alternatively. In addition, the bandwidth of the measurement channel can be selected and the span can be adjusted accordingly.

**Note:**

*The  $C/N$  measurements are only available in the frequency domain ( $\text{span} > 0$ ).*

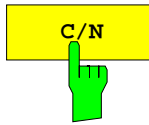

The *C/N* and *C/No* softkeys switch on the measurement of signal /noise power. For *C/No* measurement, the reference to 1 Hz bandwidth is activated in addition. After switching on the function, the *REFERENCE FIXED* marker is set to the maximum value (peak) of the active trace.

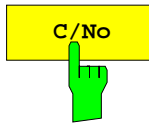

**Note:** *The measurement is performed on the trace on which marker 1 is placed. To evaluate another trace, marker 1 should be set on another using the SELECT TRACE softkey in the MKR menu. If no marker is active when the function is switched on, marker 1 is automatically enabled.*

IEC/IEEE-bus command:

```
CALC:MARK:FUNC:POW:SEL CN
CALC:MARK:FUNC:POW:RES? CN
CALC:MARK:FUNC:POW:SEL CNO
CALC:MARK:FUNC:POW:RES? CNO
CALC:MARK:FUNC:POW OFF
```



The *CHANNEL BANDWIDTH* softkey opens an input window for defining the channel bandwidth for the transmission channel.

Default setting is 14 kHz.

The specified channel bandwidth is used for optimization of the test parameters of the ESPI with *ADJUST SETTINGS*.

IEC/IEEE-bus command:

```
SENS:POW:ACH:BWID 14kHz
```

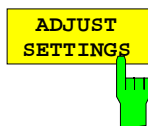

The *ADJUST SETTINGS* softkey adjusts the span to the selected channel bandwidth.

For the signal-to-noise ratio measurement the span is set to

4 x channel bandwidth + reserve

The adjustment is carried out only once; if necessary, the instrument settings can be changed later.

IEC/IEEE-bus command:

```
SENS:POW:ACH:PRES CN | CNO
```

## Measurement of the AM Modulation Depth

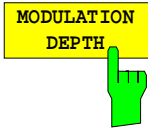

The *MODULATION DEPTH* softkey switches on the measurement of the AM modulation depth. An AM-modulated carrier is required on the screen for ensuring correct operation.

The level value of *MARKER 1* is taken as the carrier level. When this function is activated, *MARKER 2* and *MARKER 3* are automatically set symmetrically to the carrier on the adjacent peak values of the trace as delta markers and *MARKER 2* is activated for the entry.

When the position of *MARKER 2* (delta) is changed, *MARKER 3* (delta) is moved symmetrically with respect to the reference marker (*MARKER 1*).

If the data entry is activated for *MARKER 3* (*MARKER 1 2 3 4* softkey), the latter can be moved for fine adjustment irrespective of *MARKER 2*.

The ESPI calculates the power at the marker positions from the measured levels. The AM modulation depth is calculated from the ratio between the power values at the reference marker and at the delta markers. When the powers of the two AM side bands are unequal, the mean value of the two power values is used for AM modulation depth calculation.

### Measurement example:

The AM modulation depth of a carrier modulated with 1 kHz is to be measured at 100 MHz.

[PRESET]	The ESPI is set to the default setting.
[CENTER: 100 MHz]	The center frequency is set to 100 MHz.
[SPAN: 5 kHz]	The span is set to 5 kHz.
[AMPT: 0 dBm]	The reference level is set to 0 dBm.
[MKR FCTN]	<i>MARKER 1</i> is switched on and positioned at the maximum of the displayed trace.
[MODULATION DEPTH: 1 kHz]	The measurement of the AM modulation depth is switched on. <i>MARKERS 2</i> and <i>3</i> (delta markers) are set to the adjacent peak values of the trace and are activated for the frequency entry. The AM modulation depth is output in % in the marker info field. When 1 kHz is entered, <i>MARKER 2</i> can be exactly positioned on 1 kHz and <i>MARKER 3</i> at -1 kHz from the reference marker.

IEC/IEEE-bus command:      `CALC:MARK:FUNC:MDEP ON;`  
                                   `CALC:MARK:FUNC:MDEP:RES?`



## Measurement of the Third Order Intercept (TOI)

If several signals are applied to a transmission twoport with nonlinear characteristic, intermodulation products appear at its output by the sums and differences of the signals. The nonlinear characteristic produces harmonics of the useful signals which intermodulate at the characteristic. The intermodulation products of lower order have a special effect since their level is largest and they are near the useful signals. The intermodulation product of third order causes the highest interference. It is the intermodulation product generated from one of the useful signals and the 2nd harmonic of the second useful signal in case of two-tone modulation.

The frequencies of the intermodulation products are above and below the useful signals. Fig. 4-18 shows intermodulation products  $P_{I1}$  and  $P_{I2}$  generated by the two useful signals  $P_{U1}$  and  $P_{U2}$ .

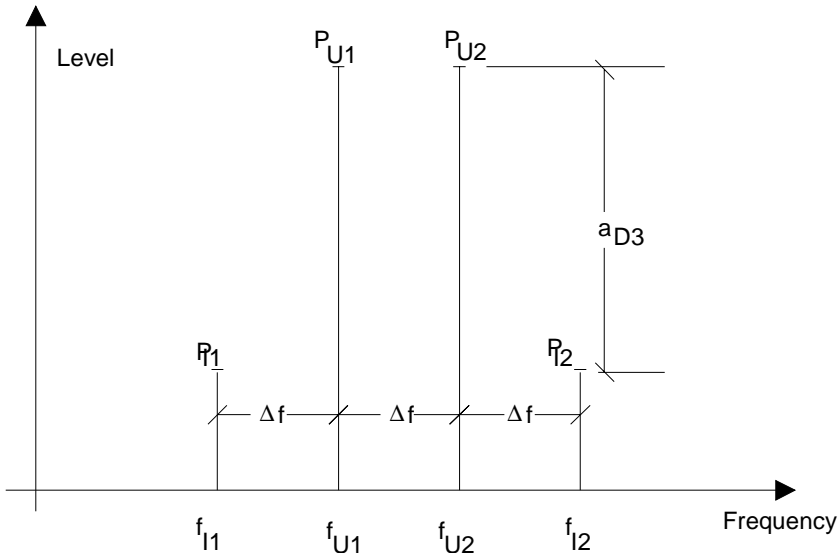

Fig. 4-18 Intermodulation products  $P_{U1}$  and  $P_{U2}$

The intermodulation product at  $f_{I2}$  is generated by mixing the 2nd harmonic of useful signal  $P_{U2}$  and signal  $P_{U1}$ , the intermodulation product at  $f_{I1}$  by mixing the 2nd harmonic of useful signal  $P_{U1}$  and signal  $P_{U2}$ .

$$f_{I1} = 2 \times f_{U1} - f_{U2} \quad (1)$$

$$f_{I2} = 2 \times f_{U2} - f_{U1} \quad (2)$$

The level of the intermodulation products depends on the level of the useful signals. If the two useful signals are increased by 1 dB, the level of the intermodulation products increases by 3 dB, which means that spacing  $a_{D3}$  between intermodulation signals and useful signals is reduced by 2 dB. This is illustrated in Fig. 4-19.

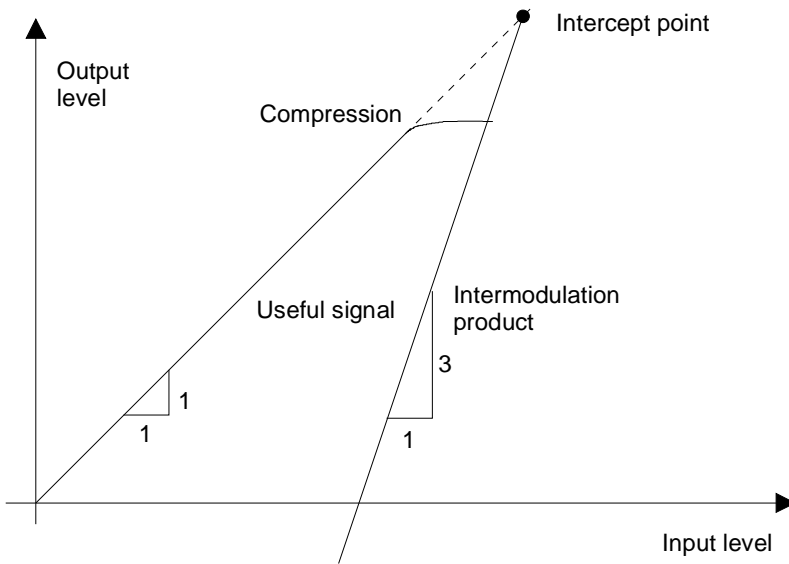

Fig. 4-19 Dependence of intermodulation level on useful signal level

The useful signals at the twoport output increase proportionally with the input level as long as the twoport is in the linear range. A level change of 1 dB at the input causes a level change of 1 dB at the output. Beyond a certain input level, the twoport goes into compression and the output level stops increasing. The intermodulation products of the third order increase three times as much as the useful signals. The intercept point is the fictitious level where the two lines intersect. It cannot be measured directly since the useful level is previously limited by the maximum twoport output power. It can be calculated from the known line slopes and the measured spacing  $a_{D3}$  at a given level according to the following formula.

$$IP3 = \frac{a_{D3}}{2} + P_N \tag{3}$$

The 3<sup>rd</sup> order intercept point IP3, for example, is calculated for an intermodulation of 60 dB and an input level  $P_U$  of -20 dBm according to the following formula:

$$IP3 = \frac{60}{2} + (-20dBm) = 10dBm. \tag{4}$$

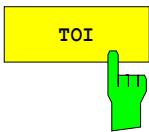

The *TOI* softkey enables the measurement of the 3<sup>rd</sup> order intercept point. A two-tone signal with equal carrier levels is expected at the ESPI input. *MARKER 1* and *MARKER 2* (both normal markers) are set to the maximum of the two signals. *MARKER 3* and *MARKER 4* (both delta markers) are placed on the intermodulation products. When the function is enabled, the frequency entry is activated for the delta markers. They can be set manually. The ESPI calculates the third order intercept from the level spacing between normal markers and delta markers and outputs it in the marker info field.

IEC/IEEE-bus command:      `CALC:MARK:FUNC:TOI ON;`  
                                  `CALC:MARK:FUNC:TOI:RES?`

**Example:**

A two-tone signal with frequencies of 100 MHz and 101 MHz is applied to the RF input of the ESPI. The level of the two signals is -10 dBm.

[PRESET]	The ESPI is set to the default setting.
[CENTER: 100.5 MHz]	The center frequency is set to 100.5 MHz.
[SPAN: 3 MHz]	The span is set to 3 MHz.
[AMPT: -10 dBm]	The reference level is set to -10 dBm.
[MKR FCTM]	MARKER 1 is switched on and set to the signal peak.
[TOI]	The ESPI sets the 4 markers to the useful signals and the intermodulation products and calculates the third order intercept. The result is output in the marker info field.



The *SELECT MARKER* softkey activates the selection of a marker for functions *MODULATION DEPTH* and *TOI*. Thus, the markers can be fine-adjusted for these functions.

The markers are numerically selected in a data entry field. Delta marker 1 is selected by entering '0'.

If the marker is in the switch-off state, it will be switched on and can thus be shifted.

IEC/IEEE-bus command:	CALC:MARK1 ON;
	CALC:MARK1:X <value>;
	CALC:MARK1:Y?

## Setup of Limit and Display Lines– *LINES* Key

Limit lines are used to define amplitude curves or spectral distribution boundaries on the display screen which are not to be exceeded. They indicate, for example, the upper limits for interference radiation or spurious waves which are allowed from a Unit Under Test (UUT). For transmission of information in TDMA (e.g., GSM), the amplitude of the bursts in a time slot must adhere to a curve which must fall within a specified tolerance band. The lower and upper limits may each be specified by a limit line. Then, the amplitude curve can be controlled either visually or automatically for any violations of the upper or lower limits (GO/NOGO test).

The instrument supports limit lines with a maximum of 50 data points. 8 of the limit lines stored in the instrument can be used simultaneously and activated in the split-screen mode either in Screen A, Screen B or in the two windows. The number of limit lines stored in the instrument is only limited by the capacity of the flashdisk used.

For each limit line, the following characteristics must be defined:

- The name of the limit line. The limit line data are stored under this name and can be examined in the table *LIMIT LINES*.
- The domain in which the limit line is to be used. Here, a distinction is made between the time domain (span = 0 Hz, analyzer mode only) and the frequency domain (span > 0 Hz).
- The reference of the interpolation points to the X-axis. The limit line may be specified either for absolute frequencies or times or for frequencies which are related to the set center frequency and times related to the time on the left edge of the diagram. In receiver mode, only absolute scaling is used.
- The reference of the interpolation points to the Y-axis. The limit line can be selected either for absolute levels or voltages or referred to the set maximum level (Ref Lvl). The position on the display depends on the *REF LEVEL POSITION*. In receiver mode, only absolute scaling is used.
- With relative reference values for the Y axis, it is possible to enter an absolute threshold (THRESHOLD) which lowers the relative limit values (see below, analyzer mode only).
- The type of limit line (upper or lower limit, lower limit for analyzer mode only). With this information and the active limit checking function (Table *LIMIT LINES*, *LIMIT CHECK ON*, analyzer mode only), the ESPI checks for compliance with each limit.
- The limit line units to be used. The units of the limit line must be compatible with the level axis in the active measurement window.
- The measurement curve (trace) to which the limit line is assigned. For the ESPI, this defines the curve to which the limit is to be applied when several traces are simultaneously displayed.
- For each limit line, a margin can be defined which serves as a threshold for automatic evaluation.
- In addition, commentary can be written for each limit line, e.g., a description of the application.

Display lines are exclusively used to visually mark the relevant frequencies and times (span = 0) as well as the constant level values. An automatic limit check for any violations of the upper or lower limits is not possible for the display lines.

## Selection of Limit Lines

The *LINES* key calls up the menu for setup of the limit lines.

*LINES* menu



The *SELECTED LIMIT LINE* display field provides information concerning the characteristics of the marked limit lines.

In the *LIMIT LINES* table, the limit lines compatible to the settings of the active screen can be enabled.

New limit lines can be specified and edited in the *NEW LIMIT LINE* and *EDIT LIMIT LINE* sub-menus, respectively.

The horizontal and vertical lines of submenu *DISPLAY LINES* are used to mark particular levels or frequencies (span > 0) or times (span = 0) in the diagram.

The *SELECTED LIMIT LINES* table provides information about the characteristics of the marked limit line :

<i>Name</i>	name
<i>Domain</i>	frequency or time
<i>Unit</i>	vertical scale
<i>X-Axis</i>	interpolation
<i>Limit</i>	upper/lower limit
<i>X-Scaling</i>	absolute or relative frequencies/times
<i>Y-Scaling</i>	absolute or relative Y-units
<i>Threshold</i>	absolute limit with relative Y-units
<i>Comment</i>	commentary

The characteristics of the limit line are set in the *EDIT LIMIT LINE* (=NEW LIMIT LINE) sub-menu.

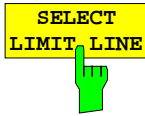

The *SELECT LIMIT LINE* softkey activates the *LIMIT LINES* table and the selection bar jumps to the uppermost name in the table.

The following information is offered in the columns of the table:

<i>Name</i>	Enable the limit line.
<i>Compatible</i>	Indicates if the limit line is compatible with the measurement window of the given trace.
<i>Limit Check</i>	Activate automatic violation check for upper/lower limits.
<i>Trace</i>	Select the measurement curve to which the limit is assigned.
<i>Margin</i>	Define margin.

### **Name and Compatible - Enabling limit lines**

A maximum of 8 limit lines can be enabled at any one time. In split screen mode, they may be assigned to screen A, screen B or to both screens. A check mark at the left edge of a cell indicates that this limit line is enabled.

A limit line can only be enabled when it has a check mark in the *Compatible* column, i.e., only when the horizontal display (time or frequency) and vertical scales are **identical** to those of the display in the measurement window.

Lines with the unit dB are compatible to all dB(..) settings of the Y-axis.

If the scale of the y-axis or the domain (frequency or time axis) are changed, all non-compatible limit lines are automatically switched off in order to avoid misinterpretation. The limit lines must be enabled anew when the original display is re-displayed.

```
IEC/IEEE-bus command:      CALC:LIM3:NAME "GSM1"
                           CALC:LIM3:UPP:STAT ON
                           CALC:LIM4:LOW:STAT ON
```

**Limit Check - Activate automatic limit violation check (analyzer mode only) .**

When *LIMIT CHECK ON* is activated, a GO/NOGO test is performed in the active screen. In the center of the diagram, a display window appears which indicates the results of the limit check test:

LIMIT CHECK: PASSED    No violations of active limits.

LIMIT CHECK: FAILED    One or more active limit lines were violated. The message contains the names of the limit lines which were violated or whose margins were not complied with.

LIMIT CHECK: MARGIN    The margin of at least one active limit lines was not complied with, however, no limit line was violated. The message contains the names of the limit lines whose margins were not complied with.

The following example shows two active limit lines:

```
LIMIT CHECK: FAILED
LINE VHF_MASK: Failed
LINE UHF2MASK: Margin
```

A check for violations of limit lines takes place only if the limit line of the assigned measurement curve (trace) is enabled.

If *LIM CHECK* is set to *OFF* for all active limit lines, then the limit line check is not executed and the display window is activated.

IEC/IEEE-bus command:        `CALC:LIM:STAT ON`  
                                  `INIT;*WAI`  
                                  `CALC:LIM:FAIL?`

**Trace - Select the measurement curve to which the limit line is assigned.**

The selection of the measurement curve (trace) takes place in an entry window. Allowed are the integer entries 1, 2 or 3. The default setting is trace 1. If the selected limit line is not compatible with the assigned measurement curve, then the limit line is disabled (display and limit check).

IEC/IEEE-bus command:        `CALC:LIM:TRAC 1`

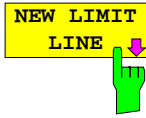

See following Section "Entry and Editing of Limit Lines".

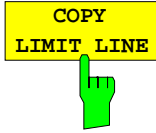
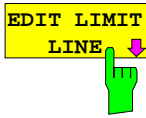

The *COPY LIMIT LINE* softkey copies the data file describing the marked limit line and saves it under a new name. In this way, a new limit line can be easily generated by parallel translation or editing of an existing limit line. The name can be arbitrarily chosen and input via an entry window (max. of 8 characters).

IEC/IEEE-bus command:      `CALC:LIM3:COPY 2`            or  
    `CALC:LIM3:COPY "GSM2"`



The *DELETE LIMIT LINE* softkey erases the selected limit line. Before deletion, a message appears requesting confirmation.

IEC/IEEE-bus command:      `CALC:LIM3:DEL`

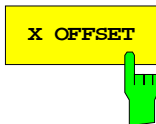

The *X OFFSET* softkey horizontally shifts a limit line, which has been specified for relative frequencies or times (X-axis). The softkey opens an entry window, where the value for shifting may be entered numerically or via the roll-key.

**Note:**      *This softkey is without effect on limit lines, which have been specified for absolute frequencies or times (X-axis).*

IEC/IEEE-bus command:      `CALC:LIM3:CONT:OFFS 10kHz`



The *Y OFFSET* softkey vertically shifts a limit line, which has relative values for the Y-axis (levels or linear units such as volt). The softkey opens an entry window where the value for shifting may be entered numerically or via the roll-key.

**Note:**      *This softkey is without effect on limit lines, which have been specified for absolute values for the Y-axis.*

IEC/IEEE-bus command:      `CALC:LIM3:LOW:OFFS 3dB`  
    `CALC:LIM3:UPP:OFFS 3dB`



## Entry and Editing of Limit Lines



A limit line is characterized by

- its name
- the assignment of domain (frequency or time)
- the scaling in absolute or relative times or frequencies
- the vertical unit
- the interpolation
- the vertical scaling
- the vertical threshold (only with relative vertical scaling)
- the margin
- the definition of the limit line as either upper or lower limit.
- the data points for frequency/time and level

At the time of entry, the ESPI immediately checks that all limit lines are in accordance with certain guidelines. These guidelines must be observed if specified operation is to be guaranteed.

- The frequencies/times for each data point must be entered in ascending order, however, for any single frequency/time, two data points may be input (vertical segment of a limit line).

The data points are allocated in order of ascending frequency/time. Gaps are not allowed. If gaps are desired, two separate limit lines must be defined and then both enabled.

- The entered frequencies/times must not necessarily be selectable in ESPI. A limit line may also exceed the specified frequency or time domains. The minimum frequency for a data point is -200 GHz, the maximum frequency is 200 GHz. For the time domain representation, negative times may also be entered. The allowable range is -1000 s to +1000 s.
- The minimum/maximum value for a limit line is -200 dB to +200 dB for the logarithmic or  $10^{-20}$  to  $10^{+20}$  or -99.9% to + 999.9% for the linear amplitude scales.

LINES - EDIT LIMIT LINE menu

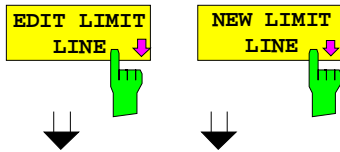

The *EDIT LIMIT LINE* and *NEW LIMIT LINE* softkeys both call the *EDIT LIMIT LINE* sub-menu used for editing limit lines. In the table heading, the characteristics of the limit line can be entered. The data points for frequency/time and level values are entered in the columns.

<i>Name</i>	Enter name.
<i>Domain</i>	Select domain.
<i>Unit</i>	Select units.
<i>X-Axis</i>	Select interpolation
<i>Limit</i>	Select upper and lower limit value.
<i>X-Scaling</i>	Entry of absolute or relative values for the X-axis
<i>Y-Scaling</i>	Entry of absolute or relative values for the Y-axis
<i>Margin</i>	Entry of margin.
<i>Threshold</i>	Entry of vertical threshold (only with relative vertical scaling)
<i>Comment</i>	Enter comments.
<i>Time/Frequency</i>	Enter time/frequency for the data points.
<i>Limit/dBm</i>	Enter magnitudes for the data points.

**Note:** *Domain, unit, X scaling and Y scaling cannot be modified as soon as reference values have been entered in the data section of the table.*

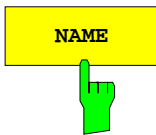

The *NAME* softkey enables the entry of characteristics in the table heading.

**Name - Enter name**

A maximum of 8 characters is permitted for each name. All names must be compatible with the MS DOS conventions for file names. The instrument stores all limit lines with the .LIM extension.

IEC/IEEE-bus command:        `CALC:LIM3:NAME "GSM1"`

**Domain - Select time or frequency domain**

The default setting is frequency. In receiver mode, only the frequency domain can be selected.

**Note:** *A change in domain (frequency/time) is only permitted when the data point table is empty.*

IEC/IEEE-bus command:        `CALC:LIM3:CONT:DOM FREQ`

**X-Axis - Select interpolation**

Linear or logarithmic interpolation can be carried out between the frequency reference points of the table. The ENTER key toggles between LIN and LOG selection.

IEC/IEEE-bus commands      CALC:LIM3:CONT:SPAC LIN  
   CALC:LIM3:UPP:SPAC LIN  
   CALC:LIM3:LOW:SPAC LIN

**Scaling - selection of absolute or relative scaling**

The limit line can either be scaled in absolute (frequency or time) or relative units. In receiver mode, only absolute scaling is used. Any of the unit keys may be used to toggle between *ABSOLUTE* and *RELATIVE*, the cursor must be positioned in the *X-Scaling* or the *Y-Scaling* line.

*X-Scaling ABSOLUTE*      The frequencies or times are interpreted as absolute physical units.

*X-Scaling RELATIVE*      In the data point table, the frequencies are referred to the currently set center frequency. In time domain mode, the left boundary of the diagram constitutes the reference.

*Y-Scaling ABSOLUTE*      The limit values refer to absolute levels or voltages.

*Y-Scaling RELATIVE*      The limit values refer to the reference level (Ref Level) or, in case a reference line is set, to the reference line.  
 Limit values with the unit dB are always relative values.

The *RELATIVE* scaling is always suitable, if masks for bursts are to be defined in the time domain, or if masks for modulated signals are required in the frequency domain.

An X-offset with half the sweep time may be entered in order to shift the mask in the time domain into the center of screen.

IEC/IEEE-bus command:      CALC:LIM3:CONT:MODE ABS  
   CALC:LIM3:UPP:MODE ABS  
   CALC:LIM3:LOW:MODE ABS

**Unit - Select the vertical scale units for the limit line**

The selection of units takes place in a selection box. The default setting is dBm.

UNITS VERTICAL SCALE	
	dB
✓	<b>dBm</b>
	%
	dBuV
	dBmV
	dBuA
	dBpW
	V
	A
	W

IEC/IEEE-bus command:      CALC:LIM3:UNIT DBM

**Limit - Select upper/lower limit**

A limit line can be defined as either an upper or lower limit. In receiver mode, only the upper limit line is used.

IEC/IEEE-bus command:        --  
(defined by key words :UPPer or :LOWer)

**Margin - Setting a margin.**

The margin is defined as the signal-level distance to the limit line . When the limit line is defined as an upper limit, the margin means that the level is below the limit line. When the limit line is defined as a lower limit, the margin means that the level is above the limit line. The default setting is 0 dB (i.e., no margin).

IEC/IEEE-bus command:        CALC:LIM3:UPP:MARG 10dB  
                                  CALC:LIM3:LOW:MARG 10dB

**Threshold – Selection of the threshold value with relative Y scaling**

With relative Y scaling, an absolute threshold value can be defined which lowers the relative limit values. The function is useful especially for mobile radio applications provided the limit values are defined in relation to the carrier power as long as they are above an absolute limit value.

Example:

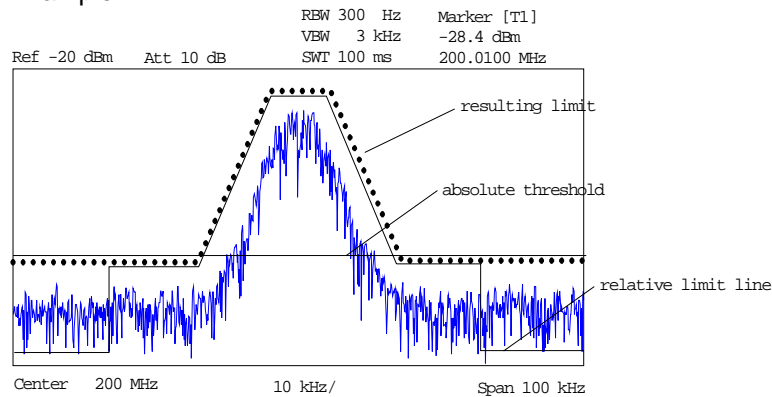

The preset value is at -200 dBm. The field is displayed if the value RELATIVE is entered in the field Y-SCALING.

IEC/IEEE-bus command:        CALC:LIM3:UPP:THR -30 dBm  
                                  or  
                                  CALC:LIM3:LOW:THR -30 dBm

**Comment - Enter comments**

Comments are arbitrary, however, they must be less than 41 characters long.

IEC/IEEE-bus command:        CALC:LIM3:COMM "Upper limit"

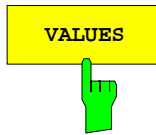

The *VALUES* softkey activates the entry of the data points in the table columns *Time/Frequency* and *Limit/dB*. Which table columns appear depends upon the *Domain* selection in the table heading.

The desired frequency/time data points are entered in ascending order (two repeated frequencies/time values are permitted).

IEC/IEEE-bus command: `CALC:LIM3:CONT:DATA 1MHz,3MHz,30MHz`  
`CALC:LIM3:UPP:DATA -10,0,0`  
`CALC:LIM3:LOW:DATA -30,-40,-40`

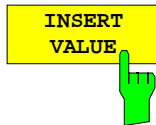

The *INSERT VALUE* softkey creates an empty line above the current cursor position where a new data point may be entered. However, during the entry of new values, it is necessary to observe an ascending order for frequency/time.

IEC/IEEE-bus command: --

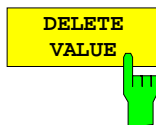

The *DELETE VALUE* softkey erases the data point (complete line) at the cursor position. All succeeding data points are shifted down accordingly.

IEC/IEEE-bus command: --

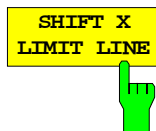

The *SHIFT X LIMIT LINE* softkey calls an entry window where the complete limit line may be shifted parallel in the horizontal direction.

The shift takes place according to the horizontal scale:

- in the frequency domain in Hz, kHz, MHz or GHz
- in the time domain in ns,  $\mu$ s, ms or s

In this manner, a new limit line can be easily generated based upon an existing limit line which has been shifted horizontally and stored (*SAVE LIMIT LINE* softkey) under a new name (*NAME* softkey).

IEC/IEEE-bus command: `CALC:LIM3:CONT:SHIF 50kHz`

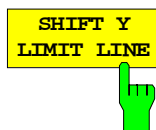

The *SHIFT Y LIMIT LINE* softkey calls an entry window where the complete limit line may be shifted parallel in the vertical direction.

The shift takes place according to the vertical scale:

- for logarithmic units, relative, in dB
- for linear units, as a factor

In this manner, a new limit line can be easily generated based upon an existing limit line which has been shifted vertically and stored (*SAVE LIMIT LINE* softkey) under a new name (*NAME* softkey).

IEC/IEEE-bus command: `CALC:LIM3:CONT:UPP:SHIF 20dB`  
`CALC:LIM3:CONT:LOW:SHIF 20dB`

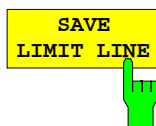

The *SAVE LIMIT LINE* softkey stores the currently edited limit line. The name can be entered in an input window (max. 8 characters)

IEC/IEEE-bus command: --

## Display Lines

Display lines are aids which, similar to markers, make the evaluation of trace data more convenient. The function of display lines is similar to that of a movable scale which can be used to measure absolute and differential values on traces.

The ESPI provides four different types of display lines:

- two horizontal threshold lines for indicating levels – Display Line 1/2,
- two vertical frequency/time lines for indicating frequencies/times – Frequency/Time Line 1/2,

For purposes of clarity, each line is annotated on the right side of the display diagram by the following abbreviations:

D1	Display Line 1
D2	Display Line 2
F1	Frequency Line 1
F2	Frequency Line 2
T1	Time Line 1
T2	Time Line 2

The lines for level are displayed as continuous, horizontal lines over the full width of the diagram. They are movable in the y-direction.

The lines for frequency and time are displayed as vertical, continuous lines over the total height of the diagram. They are movable in the x-direction.

The *DISPLAY LINES* menu, used for switching on and setting the display lines, is dedicated to the chosen display in the active measurement window (span or time).

For the display of a spectrum (span  $\neq$  0), the *TIME LINE 1* and *TIME LINE 2* softkeys are inactive, For the time display (span = 0), the *FREQUENCY LINE 1* and *FREQUENCY LINE 2* softkeys are inactive.

**Note:** *The softkeys for setting and switching the display lines on and off operate similar to a three-position switch:*

*Initial condition: The line is switched off (softkey has grey background)*

*1<sup>st</sup> press: The line is switched on (softkey has red background) and data entry is activated. The position of the display line can be adjusted by using the roll-key, the step keys or through direct numerical inputs via the data-entry keypad. If some other arbitrary function is requested, the data-entry keypad is disabled. In this case, the display line remains switched on (softkey has green background).*

*2<sup>nd</sup> press: The display line is switched off (softkey has grey background).*

*Initial condition: The line is switched on (softkey has green background)*

*1<sup>st</sup> press: The line is switched on (softkey has red background) and data entry is activated. The position of the display line can be adjusted by using the roll-key, the step keys or through direct numerical inputs via the data-entry keypad. If any other arbitrary function is requested, the data-entry keypad is disabled. In this case, the display line remains switched on (softkey has green background).*

*2<sup>nd</sup> press: The display line is switched off (softkey has grey background).*

Menu *LINES*

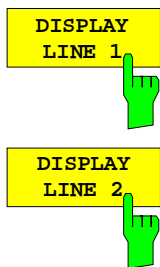
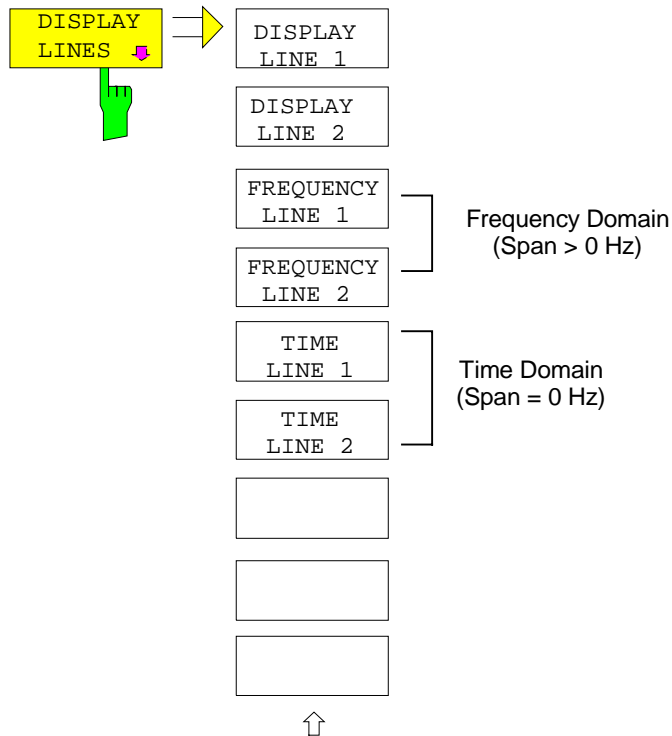

The *DISPLAY LINE 1/2* softkeys switch the display lines on/off and activate the entry of the line location.

The display lines mark the selected levels in the measurement window.

IEC/IEEE-bus commands      `CALC:DLIN:STAT ON`  
                                  `CALC:DLIN -20dBm`

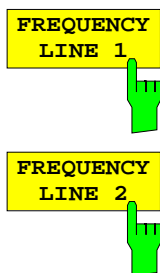

The *FREQUENCY LINE 1/2* softkeys switch the frequency lines 1/2 on/off and activate the entry of the line locations.

The frequency lines mark the selected frequencies in the measurement window or define search ranges (see section "Marker Functions").

**Note:**      *The softkeys are inactive in the time domain (Span = 0).*

IEC/IEEE-bus commands      `CALC:FLIN:STAT ON`  
                                  `CALC:FLIN 120MHz`

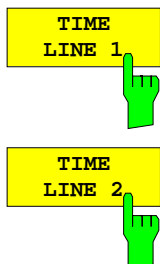

The *TIME LINE 1/2* softkeys switch the time lines 1/2 on/off and activate the entry of line locations.

The time lines mark the selected times or define the search range (see section "Marker Functions").

**Note:**      *The softkeys are inactive in the frequency domain (Span < 0).*

IEC/IEEE-bus commands      `CALC:TLIN:STAT ON`  
                                  `CALC:TLIN 10ms`

## Configuration of Screen Display – DISP Key

The *DISPLAY* menu allows the configuration of the diagram display on the screen and also the selection of the display elements and colors. The *POWER SAVE* mode is also configured in this menu for the display.

The test results are displayed on the screen of the ESPI either in a full-screen window or in two overlapping windows. The two windows are called diagram A and diagram B.

In the default setting, the two windows are completely decoupled from each other, ie they behave like two separate instruments. This is very useful, for example with harmonics measurements or measurements on frequency-converting DUTs, since the input signal and the output signal lie in different frequency ranges.

However, specific settings of the two windows (reference level, center frequency) can be coupled, if required, so that with *CENTER B = MARKER A* for example, the shift of the marker in diagram A causes the frequency range (zoomed in some cases) to be shifted along diagram B.

New settings are performed in the diagram selected via hotkey SCREEN A or SCREEN B. If only one window is displayed, it is the diagram in which the measurements are performed; the diagram not displayed is not active for measurements.

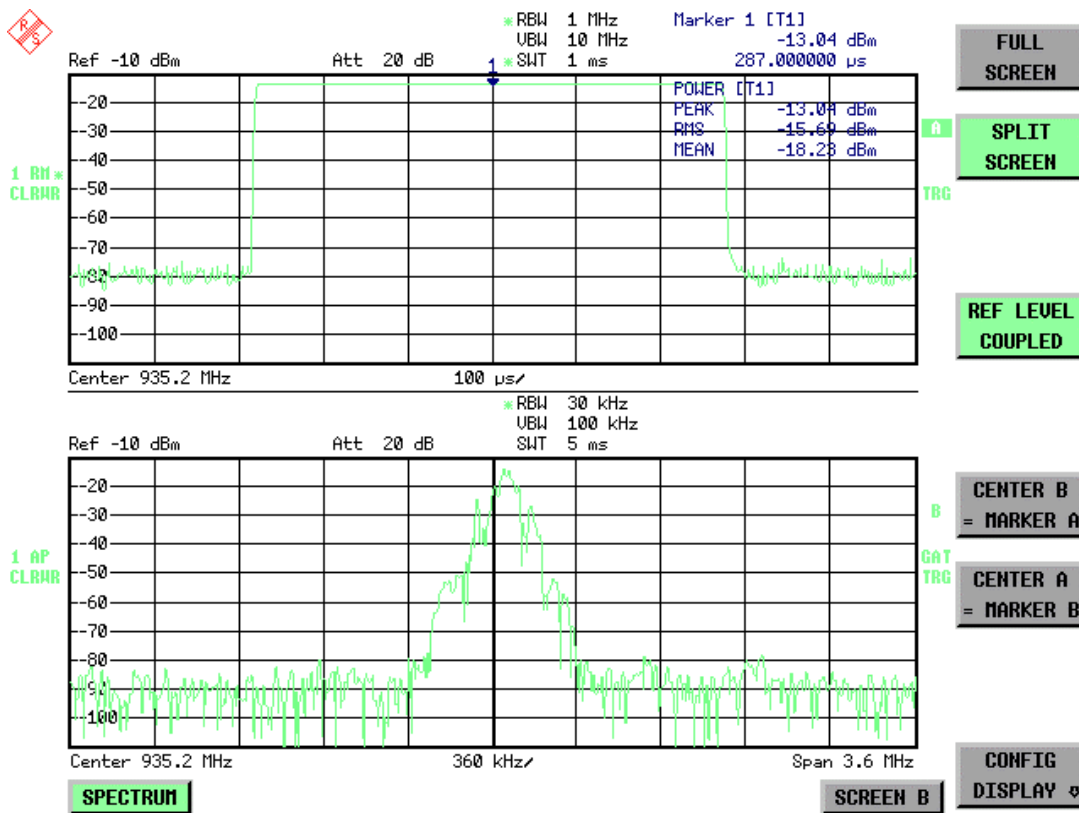

Fig. 4-20 Typical split-screen display, settings are uncoupled



The *DISP* key opens the menu for configuring the screen display and selecting the active diagram in SPLIT SCREEN mode.

The default setting after switchover to receiver mode is:

Split Screen      Screen A:            receiver bargraph  
Screen B:           receiver scan chart

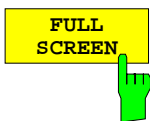
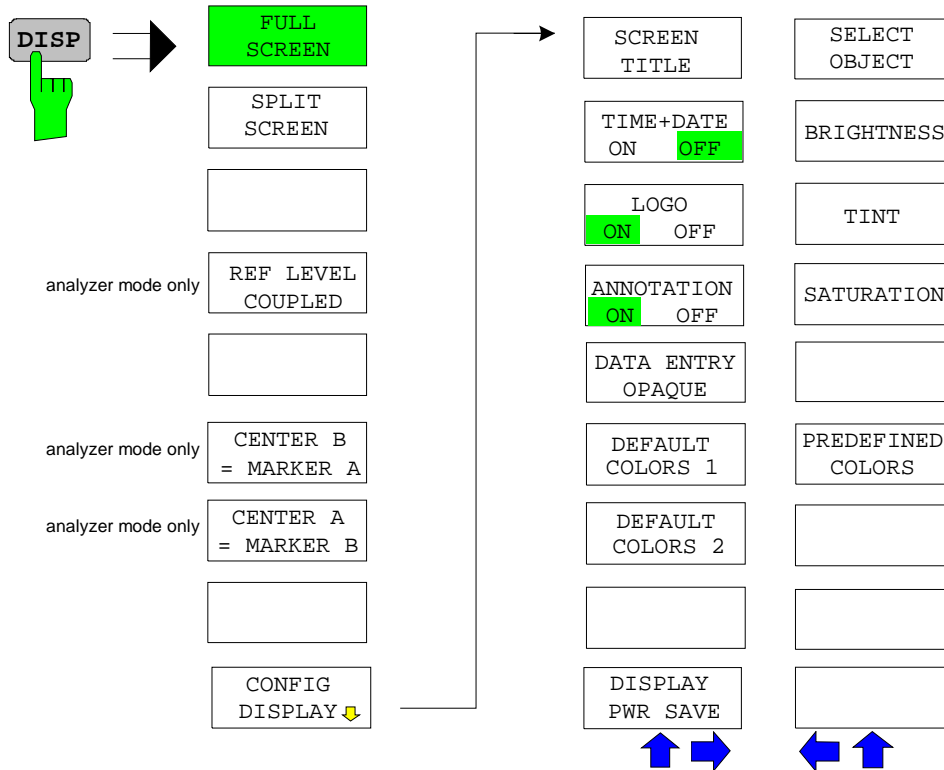

The *FULL SCREEN* softkey selects the display of one diagram. This corresponds to the default setting of ESPI in analyzer mode.

In the *FULL SCREEN* mode it is possible to switch between two different device settings by selecting the active window (screen A or screen B). Switching between *SCREEN A* and *SCREEN B* is performed by means of the corresponding key in the *HOTKEY bar*:

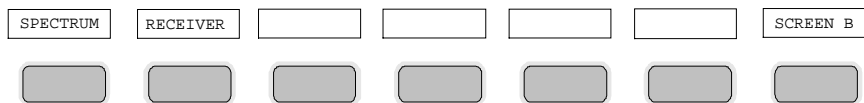

It should be noted that the measurements in the *FULL SCREEN* mode are performed only in the visible (active) window.

The active window is marked by **A** or **B** on the right of the diagram.

IEC/IEEE-bus command:      DISP:FORM SING  
  DISP:WIND<1 | 2>:SEL

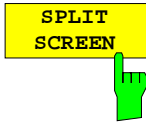

The *SPLIT SCREEN* softkey selects the display of two diagrams. The upper diagram is designated *SCREEN A*, the lower diagram *SCREEN B*. In receiver mode, screen A displays the receiver bargraph and screen B displays the scan diagram.

Switching between *SCREEN A* and *SCREEN B* is performed via the corresponding key in the *HOTKEY* bar. The active window is marked by highlighting fields **A** and **B** on the right of the diagram.

IEC/IEEE-bus command:        `DISP:FORM SPL`



The *REF LEVEL COUPLED* softkey switches the coupling of the reference level on and off. In addition to the reference level, the mixer level and input attenuation are coupled with one another.

For the level measurement, the same reference level and input attenuation must be set for the two diagrams.

IEC/IEEE-bus command        `INST:COUP RLEV`

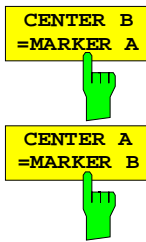

The *CENTER B = MARKER A* and *CENTER A = MARKER B* softkeys couple the center frequency in diagram B with the frequency of marker 1 in diagram A and the center frequency in diagram B with the frequency of marker 1 in diagram B. The two softkeys are mutually exclusive.

This coupling is useful, eg for viewing the signal at the marker position in diagram A with higher frequency resolution or in the time domain in diagram B.

If marker 1 is off, it is switched on and set to the maximum of the trace in the active diagram.

IEC/IEEE-bus command:        `INST:COUP CF_B`  
                                   `INST:COUP CF_A`

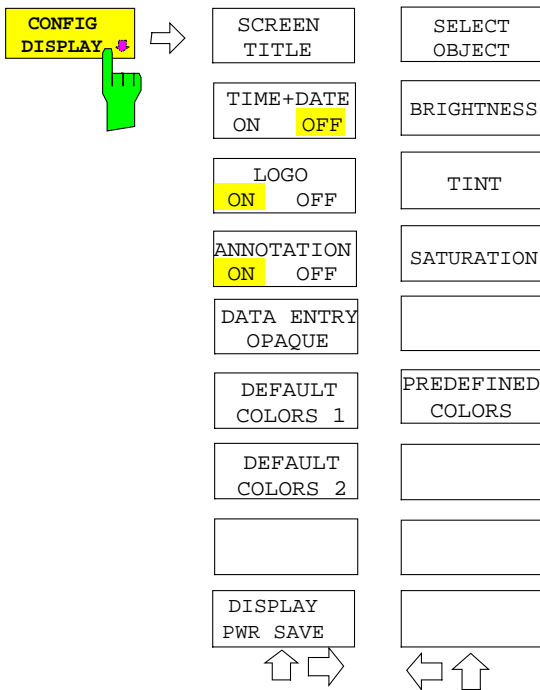

The *CONFIG DISPLAY* softkey opens a submenu allowing additional display items to be added to the screen. In addition, the display power-save mode (*DISPLAY PWR SAVE*) and the colors of the display elements can be set here.

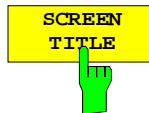

The *SCREEN TITLE* softkey activates the entry of a title for the active diagram A or B. It switches on or off a title that is already input. The length of the title is limited to max. 20 characters.

```
IEC/IEEE-bus command:  DISP:WIND1:TEXT 'Noise Meas'
                        DISP:WIND1:TEXT:STAT ON
```

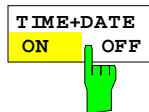

The *TIME+DATE ON/OFF* softkey switches on or off the display of date and time above the diagram.

```
IEC/IEEE-bus command:  DISP:TIME OFF
```

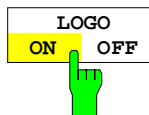

The *LOGO ON/OFF* softkey switches the Rohde & Schwarz company logo displayed in the upper left corner of the display screen on or off.

```
IEC/IEEE-bus command:  DISP:LOGO ON
```

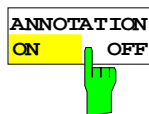

The *ANNOTATION ON/OFF* softkey switches the displaying of frequency information on the screen on and off.

- ON Frequency information is displayed.
- OFF Frequency information is not outputted to the display. This can be used for example to protect confidential data.

```
IEC/IEEE-bus command:  DISP:ANN:FREQ ON
```

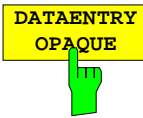

The *DATAENTRY OPAQUE* softkey sets the data entry windows to opaque. This means that entry windows are underlayed with the background color for tables.

IEC/IEEE-bus command:       --



The *DEFAULT COLORS 1 and 2* softkey restores the default settings for brightness, color tint and color saturation for all display screen elements.

The color schemes have been selected to give optimum visibility of all picture elements at an angle of vision from above or below. *DEFAULT COLORS 1* is active in the default setting of the instrument.



IEC/IEEE-bus command:       DISP:CMAP:DEF1  
                                  DISP:CMAP:DEF2



The *DISPLAY PWR SAVE* softkey is used to switch on/off the power-save mode for the display and to enter the time for the power-save function to respond. After the elapse of this time the display is completely switched off, ie including backlighting.

**Note:**       *This mode is recommended for saving the TFT display especially when the instrument is exclusively operated in remote control.*

The power-save mode is configured as follows:

- The first keystroke activates the power-save mode and opens the editor for the response time (*POWER SAVE TIMEOUT*). The response time is entered in minutes between 1 and 6 minutes and is confirmed by *ENTER*.
- The power-save mode is deactivated by pressing the key again.

On leaving the menu with the power-save mode in the activated state, the softkey is highlighted in color on returning to the menu and opens again the editor for the response time. Pressing again the key switches off the power-save mode.

IEC/IEEE-bus command: DISP:PSAV ON  
                                  DISP:PSAV:HOLD 15

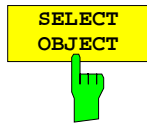

The *SELECT OBJECT* softkey activates the *SELECT DISPLAY OBJECT* table, with which a graphics element can be selected. After selection, the brightness, tint and saturation of the selected element can be changed using the softkeys of the same name. The color changes by means of the *PREDEFINED COLORS* softkey can be seen immediately on the display screen.

SELECT DISPLAY OBJECT
Background
Grid
Function field + status field + data entry text
Function field LED on
Function field LED warn
Enhancement label text
Status field background
Trace 1
Trace 2
Trace 3
Bargraph PK+
Bargraph PK-
Bargraph quasipeak
Bargraph average
Bargraph RMS
Bargraph final measurement
Marker
Lines
Measurement status + limit check pass
Limit check fail
Table + softkey text
Table + softkey background
Table selected field text
Table selected field background
Table + data entry field opaq titlebar
Data entry field opaq text
Data entry field opaq background
3D shade bright part
3D shade dark part
Softkey state on
Softkey state data entry
Logo



The *BRIGHTNESS* softkey activates entry of the brightness of the selected graphics element.

Values between 0 and 100% can be entered.

IEC/IEEE-bus: DISP:CMAP3:HSL< hue>,<sat>,<lum>

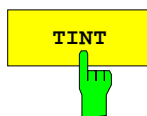

The *TINT* softkey activates the entry of the color tint of the selected element. The entered value is related to a continuous color spectrum ranging from red (0%) to blue (100%).

IEC/IEEE-bus: DISP:CMAP3:HSL <hue>,<sat>,<lum>



The *SATURATION* softkey activates the entry of the color saturation for the selected element.

The range of inputs is from 0 to 100%.

IEC/IEEE-bus: DISP:CMAP3:HSL <hue>,<sat>,<lum>



The *PREDEFINED COLORS* softkey activates a table, with which the predefined colors for the display screen elements can be selected.

COLOR
√ BLACK
BLUE
BROWN
GREEN
CYAN
RED
MAGENTA
YELLOW
WHITE
GRAY
LIGHT GRAY
LIGHT BLUE
LIGHT GREEN
LIGHT CYAN
LIGHT RED
LIGHT MAGENTA

IEC/IEEE-bus command: DISP:CMAP 1 to 32:PDEF <color>

# Instrument Setup and Interface Configuration – **SETUP** Key

The **SETUP** key opens the menu for configuration of the ESPI:

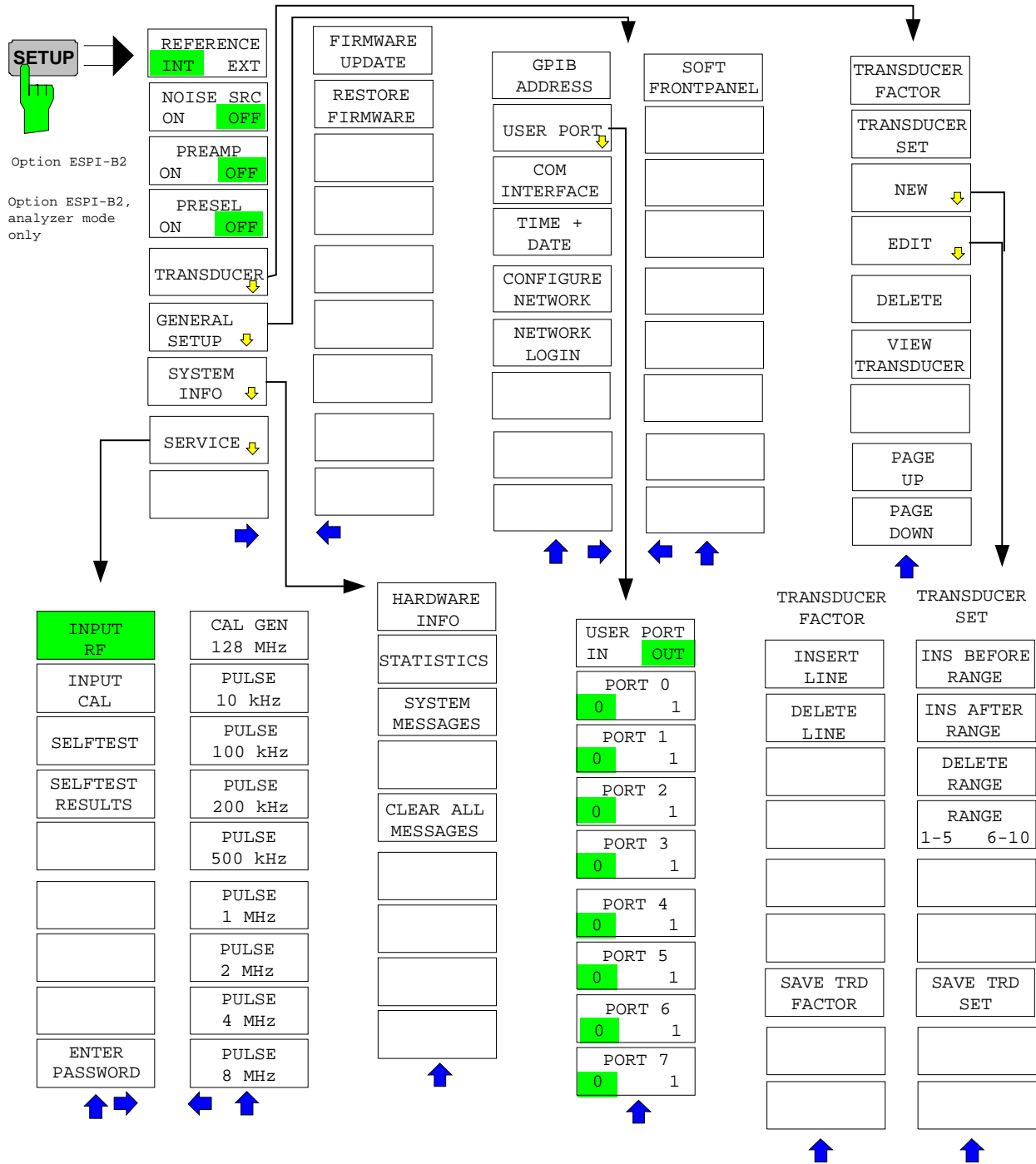

The following settings can be modified here:

- The *REFERENCE INT/EXT* softkey determines the source of the reference
- The *NOISE SRC ON/OFF* softkey switches on and off the voltage supply for an external noise source.
- The *PREAMP* softkey switches on the RF preamplifier gain. This softkey is only available with option *PRESELECTOR* (ESPI-B2).
- The *PRESELECT ON/OFF* softkey is used to switch the preselection. This softkey is only available with option *PRESELECTOR* (ESPI-B2).
- The *TRANSDUCER* softkey opens a submenu for editing and creating transducer factors and sets.
- The *GENERAL SETUP* softkey opens a submenu for all the general settings such as IEC/IEEE-bus address, date and time as well as the configuration of the device interfaces.
- The *SYSTEM INFO* softkey opens a submenu for displaying the hardware configuration of the instrument, the switching cycle statistics and system messages.
- The *SERVICE* softkey opens a submenu in which special device functions and system information can be selected for servicing. The password required for service functions can be entered in this submenu.
- The *SERVICE FUNCTIONS* softkey enables additional special settings for servicing and troubleshooting. It is available after entering the corresponding password under the *SERVICE* softkey.

## External Reference Oscillator

The ESPI can use the internal reference source or an external reference source as frequency standard from which all internal oscillators are derived. A 10 MHz crystal oscillator is used as internal reference source. In the default setting (internal reference), this frequency is available as output signal at rear-panel connector REF OUT, eg to synchronize other instruments to the reference of the ESPI.

In the setting *REFERENCE EXT*, the connector REF IN is used as input connector for an external frequency standard. In this case all internal oscillators of the ESPI are synchronized to the external reference frequency (also 10 MHz).

SETUP menu:

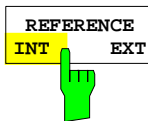

The *REFERENCE INT / EXT* softkey switches between the internal and external reference.

**Note:** *If the reference signal is missing when switching to external reference, the message "EXREF" appears after a while to indicate that there is no synchronization. On switching to internal reference please ensure that the external reference signal is de-activated to avoid interactions with the internal reference signal.*

IEC/IEEE-bus command:      ROSC:SOUR INT

## External Noise Source

SETUP menu:

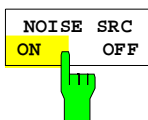

The *NOISE SRC ON/OFF* softkey switches on or off the supply voltage for an external noise source which is connected to the *NOISE SOURCE* connector on the rear panel of the instrument.

IEC/IEEE-bus command:      DIAG:SERV:NSO ON



## Preamplification and Preselection

In the frequency range up to 3 GHz, ESPI offers a preselection with switchable preamplifier (option ESPI-B2) which can be selected by the user in the analyzer mode. The preselection is always active in the receiver mode.

The 20 dB preamplifier is available only if the preselection is switched on.

### Preselection

The frequency range 9 kHz to 3 GHz is distributed over eleven filter bands.

Two fixed-tuned filters are used up to 2 MHz, eight tracking passband and high-pass filters from 2 MHz to 2000 MHz and a fixed-tuned high-pass filter above 2 GHz.

The filters are switched by a relay at 150 kHz and by PIN-diode switches above 150 kHz.

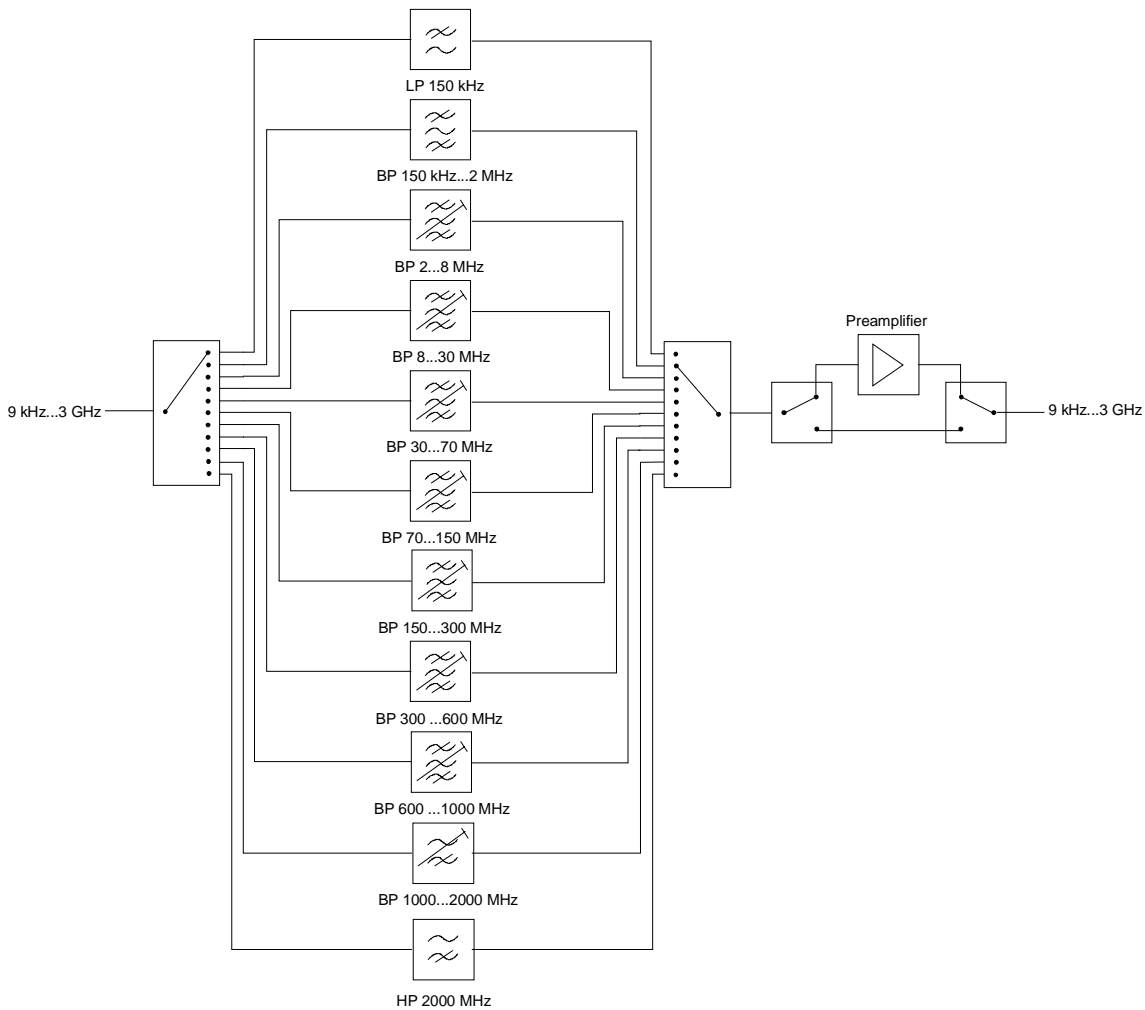
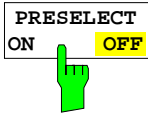

Fig. 4-21 Preselection and preamplifier

SETUP menu:



The *PRESELECT ON/OFF* softkey switches the preselection on or off.

The softkey is available only in the analyzer mode.

IEC/IEEE bus command      INP: PRES ON

Preselection causes additional dependencies which are automatically taken into account in the coupled setting.

- With the preselection active, the FFT bandwidths are not available.
- With the preselection active, the start frequency is set to 150 kHz in the FULL SPAN setting to avoid permanent switching of the relay at the band limit of 150 kHz.
- Due to the limited tuning speed of the tracking passband filters, the maximum sweep rate (3 GHz / 5 ms) can no longer be attained with the preselection switched on. The minimum settable sweep time is obtained from the sum of the minimum possible sweep times in the associated filter bands.

Filter band	Min. sweep time for filter band
9 kHz to 150 kHz	-
150 kHz to 2 MHz	-
2 to 8 MHz	500 ms
8 to 30 MHz	50 ms
30 to 70 MHz	50 ms
70 to 150 MHz	50 ms
150 to 300 MHz	50 ms
300 to 600 MHz	50 ms
600 to 1000 MHz	50 ms
1000 to 2000 MHz	50 ms
2000 to 3000 MHz	-

### Preamplification

Switching on the preamplifier diminishes the total noise figure of the ESPI, thus increasing the sensitivity. The preamplifier follows the preselection filters so that the risk of overdriving by strong out-of-band signals is reduced to a minimum. The signal level of the subsequent mixer is 20 dB higher so that the maximum input level is reduced by the gain of the preamplifier. The total noise figure of ESPI is reduced from approx. 18 dB to approx. 11 dB with the preamplifier switched on. The use of the preamplifier is recommended when measurements with a maximum sensitivity are to be performed. If the measurement should be performed at maximum dynamic range, the preamplifier should be switched off.

The gain of the preamplifier is automatically considered in the level display. On switching on the preamplifier the RF attenuation or the reference level is adapted depending on the settings of the ESPI.

SETUP menu:

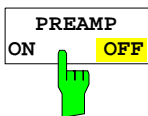

The *PREAMP ON/OFF* softkey switches the preamplifier on or off.

The softkey is available only in the analyzer mode when the measurement with preselection is activated.

IEC/IEEE bus command      : INP>: GAIN: STAT OFF

## Using Transducers

A transducer is often connected ahead of ESPI both during the measurement of useful signals and EMI and converts the useful or interference variable such as field strength, current or RFI voltage into a voltage across 50 Ohm.

Transducers such as antennas, probes or current probes mostly have a frequency-dependent transducer factor which can be stored in ESPI and automatically has the correct unit during level measurement.

If a transducer is switched on it is considered as part of the unit during the measurement, ie the measured values are displayed in the correct unit and magnitude. When working with two measurement windows, the transducer is always assigned to two windows.

ESPI distinguishes between **transducer factor** and **transducer set**. A transducer factor takes the frequency response of a single transfer element, eg an antenna into consideration. A transducer set can summarize different transducer factors in several subranges (several transducer factors at the same time), eg an antenna, a cable and a diplexer.

A transducer factor consists of max. 50 reference values defined with frequency, transducer factor and the unit. For the measurement between frequency values linear or logarithmic interpolation of the transducer factor can be chosen.

Several factors can be compiled in a transducer set provided that all factors have the same unit or unit "dB". The frequency range covered by a set can be subdivided into max. 10 subranges (each with up to 4 transducer factors) which follow each other without a gap, ie the stop frequency of a subrange is the start frequency of the next subrange.

The transducer factors used in a subrange have to fully cover the subrange.

The definition of a transducer set is recommended if different transducers are used in the frequency range to be measured or if a cable attenuation or an amplifier has to be taken into consideration.

If a transducer set is defined during a frequency sweep, the latter can be stopped at the interface between two transducer ranges and the user is asked to exchange the transducer.

The following message informs the user that the limit has been reached:

*TDS Range # reached, CONTINUE / BREAK*

He can continue the sweep by confirming the message (*CONTINUE*) or he can switch off the transducer (*BREAK*).

With the automatic switchover of the transducer used, the frequency sweep is not interrupted.

## Activating Transducer Factors and Transducer Sets

The *TRANSDUCER* softkey opens a submenu in which already defined transducer factors or sets can be activated or deactivated, new transducer factors or sets can be generated or existing transducer factors or sets can be edited. Tables with the defined transducer factors and sets are displayed. The table (factor or set) in which a transducer is active is set.

By switching on the transducers all the level settings and outputs are automatically made in the unit of the transducer. A change of the unit in menu *AMPT* is no longer possible as ESPI together with the transducer used is regarded as a measuring instrument. Only if the transducer has the unit dB, can the original unit at ESPI be maintained and changed.

If a transducer factor is active, "TDF" is displayed in the column of the enhancement labels and "TDS" if the transducer set is active.

After switching off all the transducers, ESPI continues to use the unit which was selected before a transducer was switched on.

In the analyzer mode, an active transducer for a sweep is uniquely calculated for each point displayed after its setting and added to the result of the level measurement during the sweep. If the sweep range is changed, the correction values are recalculated. If several measured values are combined, only a single value is taken into consideration.

In the receiver mode, the transducer is also calculated for a set scan. The transducer is uniquely calculated for each frequency point and added to the result of the level measurement as the measurement results are stored internally and can be zoomed subsequently.

If an active transducer factor/set is not defined over the whole sweep or scan range during the measurement, the missing values are replaced by zero.

*SETUP* menu:

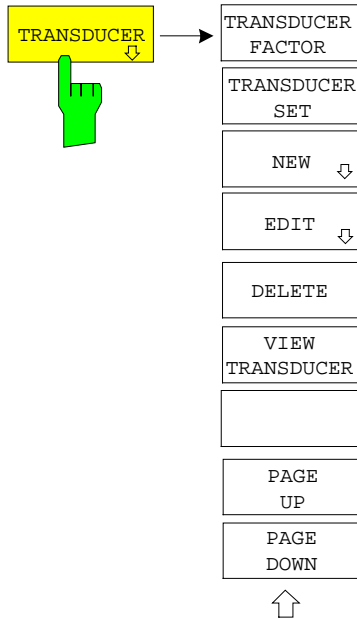

The *TRANSDUCER* softkey opens a submenu for editing existing transducer factor and sets or creating new transducer factor and sets.

Tables show the settings of already existing factors and sets as well as the settings of the active factor and set.

ACTIVE TRANSDUCER FACTOR			
Name:	Cable_1	Freq range:	10 MHz
Unit:	dB	to:	1 GHz
Comment:			

TRANSDUCER FACTOR	
Name	Unit
<input checked="" type="checkbox"/> Cable_1	dB
HK116	dBuV/m
HL223	dBuV/m

TRANSDUCER SET	
Name	Unit
30M-1G	dBuV/m

The upper table *ACTIVE TRANSDUCER FACTOR / SET* indicates the active transducer factor or the set with the associated name, frequency range and unit. If no factor or set is active, *NONE* is displayed in the table. Additional information can be entered in a comment line. If a transducer factor is active, the selected interpolation is displayed in addition, if a set is active, the break setting is displayed.

The left table *TRANSDUCER FACTOR* comprises all the defined factors with name and unit. If the number of defined transducer factors exceeds the number of possible lines in the table, the table will be scrolled.

The right table *TRANSDUCER SET* comprises all the defined transducer sets with the corresponding information.

Only one set or transducer can be activated. An already active transducer factor or set is switched off automatically if another one is switched on. An activated transducer factor or set is marked with a check sign.

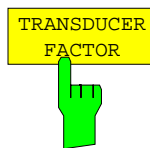

The *TRANSDUCER FACTOR* softkey sets the selection bar to the position of the active transducer factor. If no transducer factor is switched on, the bar is positioned to the first line of the table.

IEC/IEEE bus commands    `CORR:TRAN:SEL <name>`  
                                   `CORR:TRAN ON | OFF`

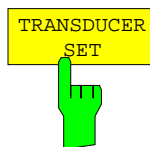

The *TRANSDUCER SET* softkey sets the selection bar to the position of the active transducer set. If no transducer set is switched on, the bar is set to the first line of the table.

IEC/IEEE bus commands    `CORR:TSET:SEL <name>`  
                                   `CORR:TSET ON | OFF`

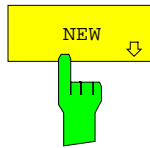

The *NEW* and *EDIT* softkeys both open the submenu for editing and creating transducer factors and sets.

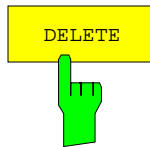
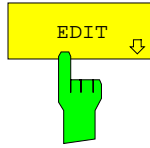

The *DELETE FACTOR/SET* softkey deletes the marked factor or set. To avoid deletion by mistake, deletion has to be confirmed.

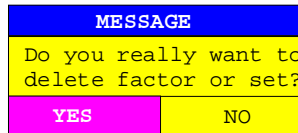

IEC/IEEE-bus command

CORR:TRAN DEL  
CORR:TSET:DEL

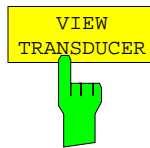

The *VIEW TRANSDUCER* softkey activates the display of the active transducer factor or set.

IEC/IEEE-bus command --

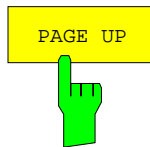

The *PAGE UP* and *PAGE DOWN* softkeys are used to scroll in large tables which cannot fully be displayed on the screen.

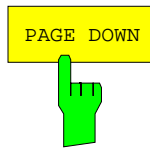

## New Entry and Editing of Transducer Factors

A transducer factor is characterized by

- reference values with frequency and transducer factor (*Values*)
- the unit of the transducer factor (*Unit*) and
- the name (*Name*) to distinguish between the different factors.

During the entry, ESPI checks the transducer factor according to specific rules that have to be met to ensure trouble-free operation.

- The frequencies for the reference values always have to be entered in ascending order. Otherwise, the entry is not accepted and the following message is displayed:

*Frequency Sequence!*

- The entered frequencies do not necessarily have to be set at ESPI, as only the values for the frequency display range are considered for a set sweep or scan. The minimum frequency for a reference value is 0 Hz, the maximum frequency 200 GHz.

- The minimum or maximum value for a transducer factor is -200 dB or 200 dB. The unit "dB" means that the transducer factor is always logarithmic and has nothing to do with the physical transducer factor, which, for example, establishes the relationship between field strength and voltage into 50 Ohm. If the minimum or maximum value is exceeded, ESPI signals:

*Min Level -200 dB or  
Max Level 200 dB.*

- Amplifiers have a negative transducer factor, attenuation values have to be entered as a positive transducer factor.

**Note:** *The softkeys for the unit in the menu under key AMPT are inoperative with the transducer switched on.*

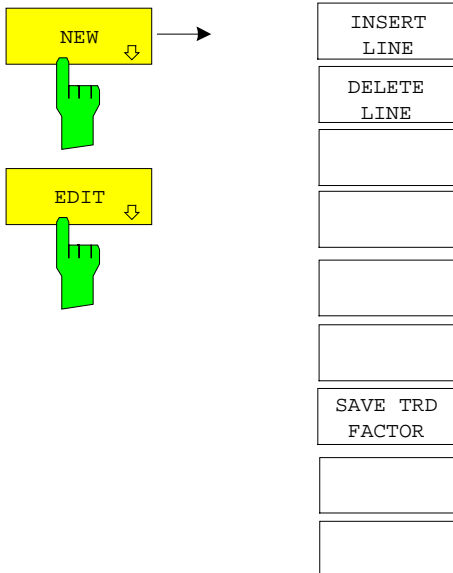

The *NEW* and *EDIT* softkeys both open the submenu for editing and entering new transducer factors if softkey *TRANSDUCER FACTOR* is active.

EDIT TRANSDUCER FACTOR			
Name/Unit/Interpolation:	Cable	dB	LIN
Comment:			
FREQUENCY	TDF/dB..	FREQUENCY	TDF/dB..
1.0000000 MHz	1.000		
1.0000000 GHz	5.500		

The table with the data of the marked factor (the *EDIT* softkey) or an empty table is displayed in which the following entries are preset (the *NEW* softkey):

Unit: dB  
 Interpolation: LIN for linear frequency scaling  
 LOG for logarithmic frequency scaling

The characteristics of the factor can be entered in the header field of the table, the frequency and the transducer factor in the columns of the table.

*Name* Entry of the name  
*Unit* Selection of unit  
*Interpolation* Selection of interpolation  
*Comment* Entry of a comment  
*FREQUENCY* Entry of the frequency of the reference points  
*TDF/dB* Entry of the transducer factor.

An overwritten transducer factor remains stored in the background as long as the edited factor is stored with the *SAVE TRD FACTOR* softkey or until the table is closed. A factor overwritten by mistake can be restored by leaving the entry.

**Name - Entry of name**

A maximum of 8 characters is permissible for the name. The characters have to comply with the convention of DOS file names. The unit automatically stores all transducer factors with the extension .TDF.

If an existing name is changed, the factor stored under the previous name is retained and will not be overwritten automatically with the new name. The previous factor can be deleted at a later time, using *DELETE*. Thus, factors can be copied.

IEC/IEEE-bus command            CORR:TRAN:SEL <name>



**Unit – Selection of unit**

The unit of the transducer factor is selected from a selection box activated by the ENTER key.

FACTOR UNIT
dB
dBm
dB $\mu$ V
dB $\mu$ V/m
dB $\mu$ A
dB $\mu$ A/m
✓ dB $\rho$ W
dB $\rho$ T

The default setting is dB.

IEC/IEEE-bus command            `CORR:TRAN:UNIT <string>`

**Interpolation - Selection of interpolation**

Linear or logarithmic interpolation can be carried out between the frequency reference points of the table. Selection is via the ENTER key which is toggled between LIN and LOG (toggle function).

IEC/IEEE-bus command            `CORR:TRAN:SCAL LIN|LOG`

The following diagrams indicate the effect of the interpolation on the calculated characteristic:

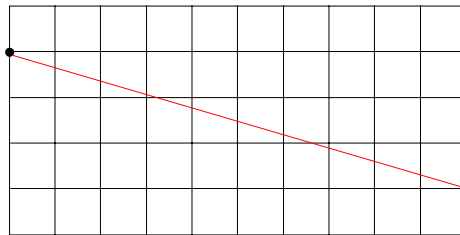

Fig. 4-22 Linear frequency axis and linear interpolation

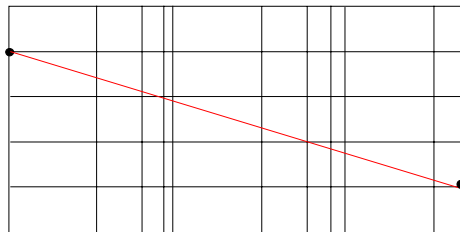

Fig. 4-23 Logarithmic frequency axis and logarithmic interpolation

**Comment - Entry of a comment**

The comment can be freely selected. It can have a maximum number of 50 characters.

IEC/IEEE-bus command            `CORR:TRAN:COMM <string>`

**FREQUENCY, TDF/dB – Input of reference values**

The selection bar marks the first reference value. The desired reference values have to be entered in ascending frequency sequence.

After entering the frequency the selection bar automatically jumps to the corresponding level value.

After entering the first reference value the table can be edited. The two *INSERT LINE* and *DELETE LINE* softkeys are displayed. Individual values are changed at a later time by marking the field and by entering the new value.

IEC/IEEE-bus command            `CORR:TRAN:DATA <freq>,<level>,...`

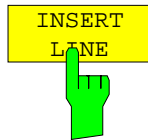

The *INSERT LINE* softkey inserts a free line above the marked reference value. When entering a new reference value into this line watch out for the ascending frequency sequence.

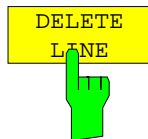

The *DELETE LINE* softkey deletes the marked reference value (the whole line). The following reference values move up.

IEC/IEEE-bus command            `--`



The *SAVE TRD FACTOR* softkey saves the changed table in a file on the internal hard disk.

If a transducer factor with the same name already exists, a corresponding query is performed beforehand.

If the factor to be newly saved is currently switched on, the new values will immediately be valid. If a transducer set is switched on comprising the factor, the values will only be used when the set is switched on next time.

IEC/IEEE-bus command            `- (executed automatically)`

### New Entry and Editing of Transducer Sets

A transducer set is characterized by:

- maximum 10 ranges (*Ranges*) in which different transducer factors can be active
- the combination of several transducer factors per range (*Factor*)
- a transducer-set name (*Name*)

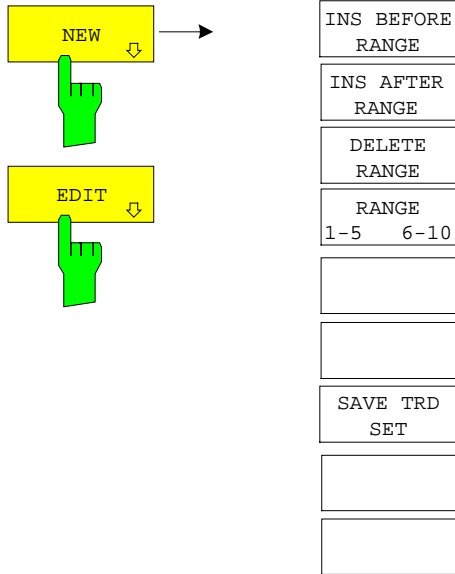

The *NEW* and *EDIT* softkeys both open the submenu for editing and entering new transducer factors if softkey *TRANSDUCER SET*.

EDIT TRANSDUCER SET					
Name/Unit/Break				dBuV	OFF
Comment :					
	RANGE1	RANGE2	RANGE3	RANGE4	RANGE5
Start	30 MHz	300 MHz			
Stop	300 MHz	1 GHz			
Factors	Cable Antenna1	Cable Preamp Antenna2			

The table with the data of the marked set (the *EDIT* softkey) or an empty table in which the following entries are preset (the *NEW* softkey) is displayed:

Unit: dB  
Break: OFF

The characteristics of the set can be entered in the header field of the table, the subranges in the columns of the set.

- Name* Entry of the name
- Unit* Selection of unit
- Break* Activating the query when changing the subrange
- Comment* Entry of a comment
- Start* Entry of the start frequency of the subrange
- Stop* Entry of the stop frequency of the subrange
- Factors* Selection of the transducer factors for the subrange

An overwritten transducer set remains stored in the background as long as the edited factor is stored with the *SAVE TRD SET* softkey or until the table is closed. A set overwritten by mistake can be restored by leaving the entry.

### Name - Entry of name

A maximum of 8 characters is permissible for the name. The characters have to comply with the convention of DOS file names. The unit automatically stores all transducer sets with the extension .TDS.

If an existing name is changed, the set stored under the previous name is retained and will not be overwritten automatically with the new name. The previous set can be deleted at a later time using *DELETE FACTOR/SET*. Thus, sets can be copied.

IEC/IEEE-bus command            `CORR:TSET:SEL <name>`

### Unit - Selection of unit

The unit of the transducer set is selected from a selection box activated by the ENTER key.

The unit should be selected prior to the entry as it determines the settable transducer factors. The preset unit for new sets is "dB".

SET UNIT	
	dB
	dBm
	dB $\mu$ V
	dB $\mu$ V/m
	dB $\mu$ A
	dB $\mu$ A/m
✓	<b>dB<math>\rho</math>W</b>
	dB $\rho$ T

IEC/IEEE-bus command            `CORR:TSET:UNIT <string>`

### Break - Activation of query when changing a subrange

The sweep can be stopped if the user changes the subrange and selects a new subrange of the transducer. A message informs the user that the limit has been attained. He can continue the sweep or switch off the transducer. The interruption is activated by setting Break to ON. Selection is by the ENTER key which toggles between ON and OFF (toggle function).

IEC/IEEE-bus command            `CORR:TSET:BRE ON|OFF`

### Start - Entry of start frequency of subrange

### Stop - Entry of stop frequency of subrange

The individual subranges have to be linked without a gap. That is why the start frequency is already defined from the second subrange (= stop frequency of previous range).

IEC/IEEE-bus command            `CORR:TSET:RANG<1.10>`  
`<freq>, <freq>, <name>..`

INS BEFORE  
RANGE



The *INS BEFORE RANGE* softkey copies the active column and inserts it to the right. The frequency limits can be edited.

IEC/IEEE-bus command --

INS AFTER  
RANGE



The *INS AFTER RANGE* softkey copies the active column and inserts it to the left. The frequency limits can be edited.

IEC/IEEE-bus command --

DELETE  
RANGE



The *DELETE RANGE* softkey deletes the marked subrange. The following subranges move left.

IEC/IEEE-bus command --

RANGES  
1-5 6-10



The *RANGES 1-5/6-10* softkey switches between the display of ranges 1 to five and ranges 6 to 10.

IEC/IEEE-bus command --

**Factors - Selection of factors for the subrange**

The permissible transducer factors for the marked subrange can be selected in a selection box. Only factors matching with the unit of the set and fully covering the selected subrange are permissible.

SELECT
V<NONE>
Cable
Antennal

After each change of range limits, ESPI thus checks the factor list and, if required, rebuilds it.

After reducing the start frequency or increasing the stop frequency of a range it may happen that the factors defined for this range no longer fully cover the range. These factors are deleted for this range when the transducer factor table is opened next time.

A maximum of 4 transducer factors can be switched on at the same time in each subrange. If none of them is switched on, 0 dB is assumed as a factor for the whole subrange.

IEC/IEEE-bus command --



The *SAVE TRD SET* softkey saves the changed table in a file on the internal hard disk. If a transducer name with the same name already exists, a corresponding query is performed beforehand:

If the saved set is switched on, the new values will be used immediately.

IEC/IEEE-bus command -- (executed automatically)

## Programming the Interface Configuration and Time Setup

The *GENERAL SETUP* softkey opens a sub-menu in which the general instrument parameters can be set up. In addition to the configuration of the digital interfaces (*IECBUS*, *COM*), the date and time may be entered.

The current settings are displayed in tabular form on the display screen where they may be edited.

*SETUP* submenu:

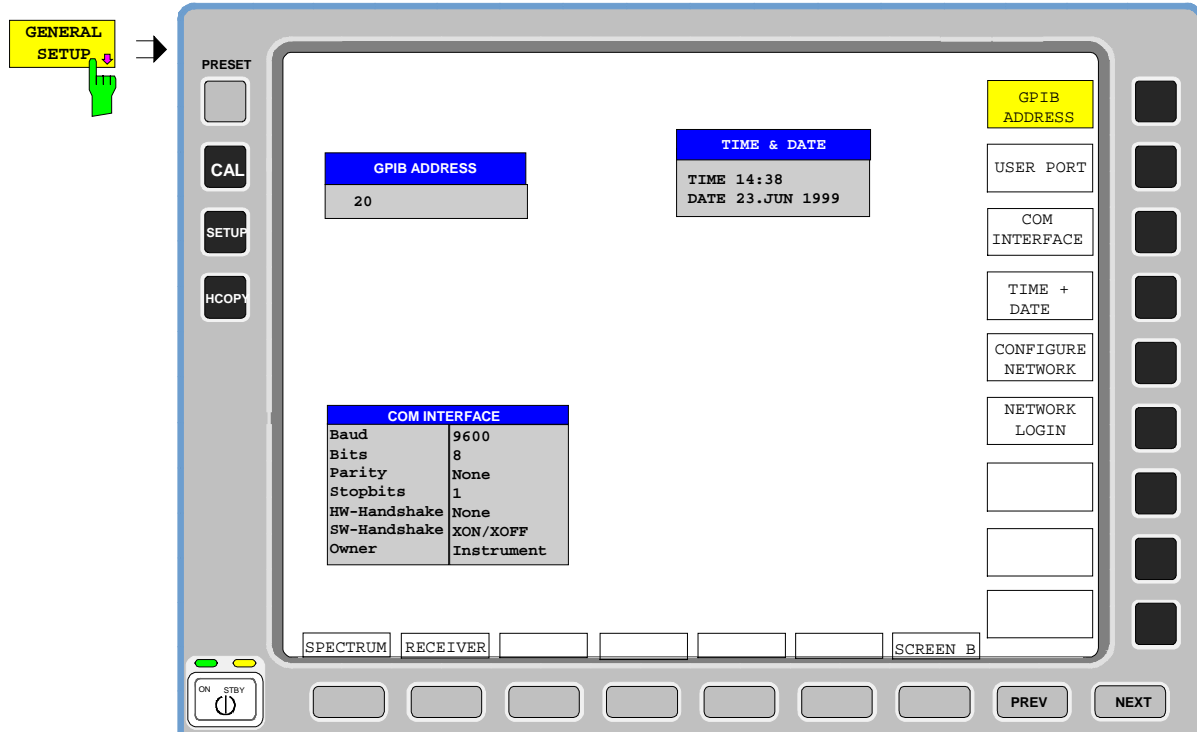

### Selecting the IEC/IEEE-bus address

*SETUP - GENERAL SETUP* submenu:

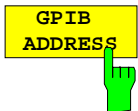

The *GPIB ADDRESS* softkey activates the entry of the IEC Bus address.

Valid addresses are 0 through 30. The default setting is address 20.

IEC/IEEE-bus command:        `SYST:COMM:GPIB:ADDR 20`

## User Port Configuration

The instrument provides a parallel interface, which is 8 bits wide. Over these ports, arbitrary bit patterns can be output or input.

CONFIGURATION SETUP-GENERAL SETUP submenu:

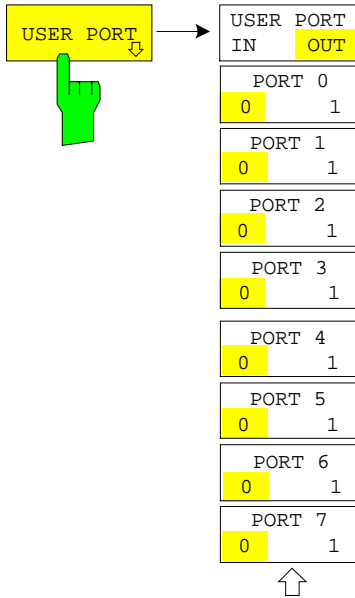

The *USER PORT* softkey opens the sub menu for setting the direction of the data transmission and for entering the values of the individual ports.

The *USER PORT IN/OUT* determines in which direction the interface transmits data.

### USER PORT (read operation)

The value is indicated in a window. A new readout is started by pressing *READ*. Pressing *OK* closes the window

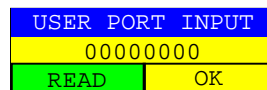

IEC/IEEE-bus command: INP:UPOR:STAT ON  
INP:UPOR?

### USER PORT OUT (write operation)

The bit pattern selected with softkeys *PORT 0* to *PORT 7* is output.

IEC/IEEE-bus command: OUTP:UPOR:STAT ON

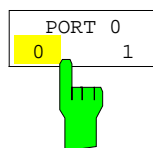

The *PORT 0 0/1* to *PORT 7 0/1* softkeys determine the output value for port 1 to 7. These softkeys are only available for setting *USER PORT OUT*.

IEC/IEEE-bus command: OUTP:UPOR STAT ON  
OUTP:UPOR #B10110010



## Serial Interface Configuration

SETUP-GENERAL SETUP submenu:

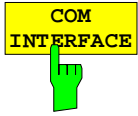

The *COM INTERFACE* softkey activates the *COM INTERFACE* table for entry of the serial interface parameters.

The following parameters can be configured in the table:

<i>Baud rate</i>	data transmission rate
<i>Bits</i>	number of data bits
<i>Parity</i>	bit parity check
<i>Stop bits</i>	number of stop bits
<i>HW-Handshake</i>	hardware handshake protocol
<i>SW-Handshake</i>	software handshake protocol
<i>Owner</i>	assignment to the measuring instrument or computer

COM INTERFACE	
Baud	9600
Bits	8
Parity	None
Stopbits	1
HW-Handshake	None
SW-Handshake	XON/XOFF
Owner	Instrument

### **Baud – Data transmission rate**

The ESPI supports baud rates between 110 and 19200 baud. The default setting is 9600 baud.

BAUD RATE
19200
✓ 9600
4800
1200
600
300
110

IEC/IEEE-bus command:           SYST:COMM:SER:BAUD 9600

### **Bits – Number of data bits per word**

For the transmission of text without special characters, 7 bits are adequate. For binary data as well as for text with special characters, 8 bits must be selected (default setting).

BITS
✓ 7
8

IEC/IEEE-bus command:           SYST:COMM:SER:BITS 7

**Parity – Bit parity check**

*NONE* no parity check (default setting)  
*EVEN* even parity check  
*ODD* odd parity check

PARITY	
<input type="checkbox"/>	NONE
<input checked="" type="checkbox"/>	EVEN
<input type="checkbox"/>	ODD

IEC/IEEE-bus command: SYST:COMM:SER:PAR NONE

**Stop bits – Number of stop bits**

Available are 1 and 2. The default setting is 1 stop bit.

STOPBITS	
<input type="checkbox"/>	1
<input checked="" type="checkbox"/>	2

IEC/IEEE-bus command: SYST:COMM:SER:SBIT 1

**HW-Handshake – Hardware handshake protocol**

The integrity of data transmission can be improved by the use of a hardware handshake mechanism, which effectively prevents uncontrolled transmission of data and the resulting loss of data bytes. For hardware handshake additional interface lines are used to transmit acknowledge signals with which the data transmission can be controlled and, if necessary, stopped until the receiver is ready to receive data again.

A prerequisite for using hardware handshaking is, however, that the interface lines (DTR and RTS) are connected on both transmitter and receiver. For a simple 3-wire connection, this is not the case and hardware handshake cannot be used here.

Default setting is *NONE*.

HW-HANDSHAKE	
<input type="checkbox"/>	None
<input checked="" type="checkbox"/>	DTR/RTS

IEC/IEEE-bus command: SYST:COMM:SER:CONT:DTR OFF  
 SYST:COMM:SER:CONT:RTS OFF

**SW-Handshake – Software handshake protocol**

Besides the hardware handshake mechanism using interface lines, it is also possible to achieve the same effect by using a software handshake protocol. Here, control bytes are transmitted in addition to the normal data bytes. These control bytes can be used, as necessary, to stop data transmission until the receiver is ready to receive data again.

In contrast to hardware handshaking, software handshaking can be realized even for a simple 3-wire connection.

One limitation is, however, that software handshaking cannot be used for the transmission of binary data, since the control characters XON and XOFF require bit combinations that are also used for binary data transmission.

Default setting is *NONE*.

SW-HANDSHAKE	
	None
<input checked="" type="checkbox"/>	XON/XOFF

IEC/IEEE-bus command:            SYST:COMM:SER:PACE NONE

**Owner – Assignment of the interface**

The serial interface can be assigned alternatively to the measuring instrument section or to the computer section

If the interface is assigned to one section of the instrument, it is not available to the other section.

**INSTRUMENT**    The interface is assigned to the measuring instrument section. Outputs to the interface from the computer section are not possible will get lost.

**OS**                    The interface is assigned to the computer section. It cannot be used by the measuring instrument section. This means that remote control of the instrument via the interface is not possible.

OWNER	
<input checked="" type="checkbox"/>	INSTRUMENT
	OS

IEC/IEEE-bus command:            --

## Setting Date and Time

SETUP-GENERAL SETUP submenu:

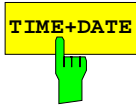

The *TIME+DATE* softkey activates the entry of time and date for the internal real time clock.

TIME AND DATE	
Time	21:59
Date	01 Oct 1997

### Time - Input of time

In the corresponding dialog box, the time is partitioned into two input fields so that hours and minutes can be entered independently.

TIME		
TIME	21	: 59

IEC/IEEE-bus command:           SYST:TIME 21,59

### Date - Input of Date

In the corresponding dialog box, the date is partitioned into 3 input fields so that day, month and year can be input separately.

DATE			
DATE	01	Oct	1999

For the selection of the month, pressing a unit key opens a list of abbreviations wherein the desired month can be selected.

MONTH
JAN
FEB
MAR
APR
MAY
JUN
JUL
AUG
SEP
✓ OCT
NOV
DEC

IEC/IEEE-bus command:           SYST:DATE 1999,10,01

### Configuration of network settings (with option FSP-B16 only)

The instrument can be connected to an Ethernet LAN (local area network) by means of the LAN Interface Option FSP-B16. This allows data transmission via the network and the use of network printers. The network card is able to handle both 10 MHz Ethernet IEEE 802.3 and 100 MHz Ethernet IEEE 802.3u.

For more details see section 'LAN Interface - Option FSP-B16'.

SETUP - GENERAL SETUP - menu:



The *CONFIGURE NETWORK* softkey opens the dialog box with the network settings.

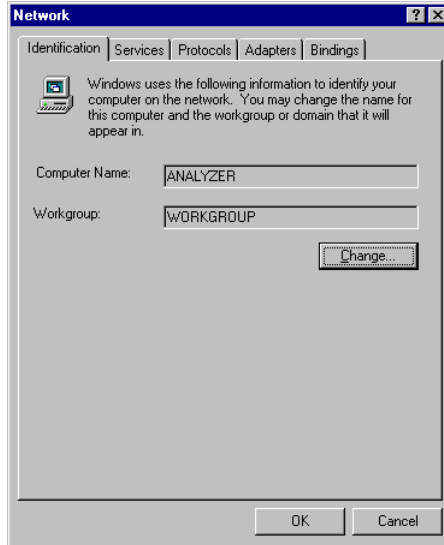

Pressing the key for the first time installs the Windows NT network support (see section 'Installation and Configuration of the Driver for the Network Card' in the section describing the LAN Interface FSP-B16) .

If the softkey is pressed again later, the existing network configuration can be changed after selecting the corresponding configuration folder. After pressing the 'Change' button the computer name and the work group on the 'Identification' folder can be adapted to network requirements.

- Notes:**
- A PC keyboard with trackball (or mouse instead) is required for the installation/configuration of the network support.
  - The softkey is only available with built-in LAN interface option (FSP-B16).

IEC/IEEE-bus command: -



The *NETWORK LOGIN* softkey opens the dialog box with the auto login settings.

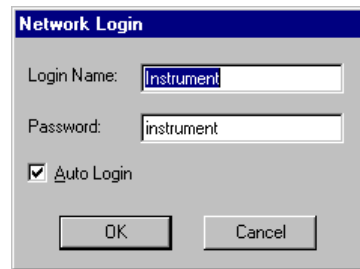

When a network is installed, the preset user name 'Instrument' and the password 'instrument' can be adapted to a new user (see section 'Defining Users' in the LAN interface manual).

With the 'Auto Login' option active, an automatic registration is performed during booting with the specified user name and password. Otherwise the Windows NT login request is displayed during booting.

- Notes:**
- A PC keyboard with trackball (or additional mouse instead) is required for the installation/configuration of the network support.
  - The softkey is only available with built-in LAN interface option (FSP-B16).
  - For information on disabling and enabling the autologin mechanism see section 'Installation and Configuration of the Driver for the Network Card' in chapter "Option LAN Interface FSP-B16".

IEC/IEEE-bus command: -

## Emulation of the instrument front panel

SETUP - GENERAL SETUP – NEXT menu:

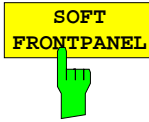

The *SOFT FRONTPANEL* softkey switches the display of the front-panel keys on and off.

When the front-panel keys are displayed on the screen, the instrument can be controlled by clicking the respective button with the mouse. This is especially useful when the instrument in a different site is controlled via a remote-control program, like for instance PCANYWHERE, and the screen contents are transferred to the controller via remote link.

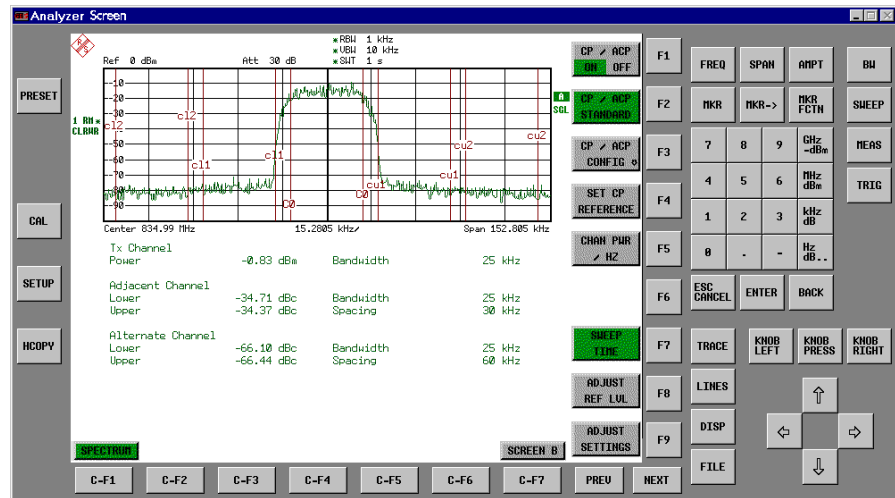

**Notes: Display resolution:**

When the display of the front-panel keys is switched on, the screen resolution of the instrument changes to 1024x768 pixels. Only a section of the total screen is then displayed on the LC display, which will automatically be shifted on mouse moves.

In order to obtain a complete display of the user interface, an external monitor is to be plugged into the corresponding connector at the rear panel. Prior to performing the resolution change the user is prompted for confirmation whether the required monitor is connected.

Switching off the front-panel display restores the original screen resolution.

**Key assignment:**

Button labels largely correspond to those of the front-panel keys. The rotation function of the rotary knob is assigned to the 'KNOB LEFT' and 'KNOB RIGHT' buttons, the press function (<ENTER>) to 'KNOB PRESS'.

The labels of the softkey buttons (F1 to F9) and of the hotkey buttons (C-F1 to C-F7) indicate that the keys can be operated directly by means of the corresponding function keys F1 to F9 or <CTRL>F1 to <CTRL>F7 of a PS/2 keyboard.

IEC/IEEE-bus command: SYST:DISP:FPAN ON

## System Information

The *SYSTEM INFO* softkey opens a submenu in which detailed information on module data, device statistics and system messages is displayed.

*SETUP* menu:



## Display of Module Data

*SETUP SYSTEM INFO* submenu:



The *HARDWARE INFO* softkey opens a table in which the modules (INSTALLED COMPONENTS) installed in the instrument are listed together with the corresponding hardware revisions.

Table *HARDWARE INFO* consists of six columns:

- SERIAL #            serial number
- COMPONENT        name of module
- ORDER #            order number
- MODEL              model number of the module
- REV                 main modification index of the module
- SUB REV            secondary modification index of the module

HARDWARE INFO						
COMPONENT	SERIAL#	ORDER#	MODEL	HWC	REV	SUB REV
RF_ATTEN_7	688557/038	1067.7684	00	00	21	00
FRONTEND1	694276/035	1093.5540	03	01	07	11
FRONTEND2	684659/010	1093.5791	03	01	05	12
IF-FILTER/REF	689712/066	1093.7242	02	00	04	04
DETECTOR	662771/012	1093.6998	02	00	02	08
Preselect_EMI	101486/001	1093.7120	02	00	01	00
AF_DEMOD	740975/052	1093.7620	02	00	03	04
CPU-Board	000117/125	1091.2489	00	00	04	11
MOTHERBOARD	101485/001	1142.8171	03	00	01	00
ESPI	834014/005	1142.8007	03	00	00	00
LAN Interface	000000/000	1093.9080	00	00	00	00

**Note:**        The screenshot lists the components of an ESPI 3 with options ESPI-B2 (Preselector) and FSP-B16 (LAN interface).



## Display of Device Statistics

SETUP SYSTEM INFO submenu:

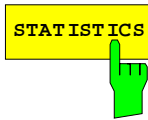

The *STATISTICS* softkey opens the table *STATISTICS*. This table contains the model information, serial number and firmware version, and a list in which the operating time of the instrument, the power-on cycles as well as attenuator switching cycles are displayed.

STATISTICS	
Model	ESPI3
Serial #	123456/789
Firmware Rev	1.23
BIOS Rev.	1.00
Operating time (hours)	375
Power On Cycles	786
Attenuator Cycles	
Input RF/Cal	57
10dB	1786
20dB	1473
40dB	675

IEC/IEEE-bus command:     --

## Display of System Messages

SETUP SYSTEM INFO submenu:

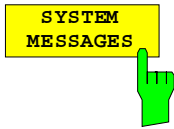

The *SYSTEM MESSAGES* softkey opens a submenu including a table in which the generated system messages are displayed in the order of their occurrence. The most recent messages are placed at the top of the list. The following information is available:

No	Device specific error code
MESSAGE	Brief description of the message
COMPONENT	On hardware messages: name of the affected module
	On Software messages: if needed, the name of the affected software components
DATE/TIME	Date and time of the occurrence of the message

Messages that have occurred since the last call to the *SYSTEM MESSAGES* menu are marked with an asterisk '\*'.  
The *CLEAR ALL MESSAGES* softkey is activated and allows clearing of the error buffer.

If the number of error messages exceeds the capacity of the error buffer, the message appearing first is "Message buffer overflow".

SYSTEM INFO			
No	MESSAGE	COMPONENT	DATE/TIME
01	No of cycles	Attenuator	05.Jan.99 10:02:00
02	VCO unlock	Frontend	05.Jan.99 10:01:30
03	Calamp range	IF Filter	05.Jan.99 10:00:50
04	3.3V: Voltage	Detector	04.Jan.99 15:58:10
05	I2C-Bus failed	CPU	04.Jan.99 15:58:05

IEC/IEEE-bus command: SYST:ERR?



The *CLEAR ALL MESSAGES* softkey deletes all messages in the table. The softkey is only available when table *SYSTEM INFO* is active.

IEC/IEEE-bus command: SYST:ERR?

## Service Menu

The service menu offers a variety of additional functions which are used for maintenance and/or trouble shooting.



**Caution:**

The service functions are not necessary for normal measurement operation. However, incorrect use can affect correct operation and/or data integrity of the ESPI. Therefore, many of the functions can only be used after entering a password. They are described in the instrument service manual.

SETUP menu:

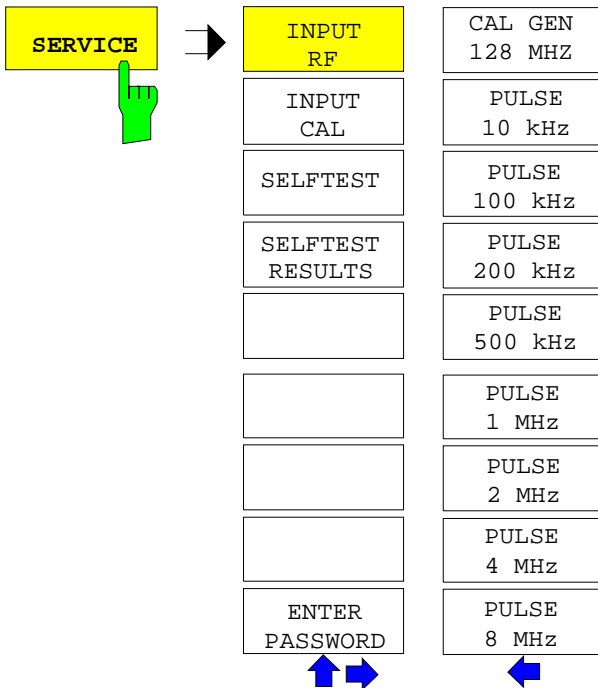

The *SERVICE* softkey opens a submenu for selection of the service function.

The *INPUT RF* and *INPUT CAL* softkeys are mutually exclusive selection switches. Only one switch can be active at any one time.

## General Service Functions

SETUP SERVICE submenu:

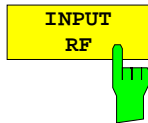

The *INPUT RF* softkey switches the input of the ESPI to the input connector (normal position).

After *PRESET*, *RECALL* or ESPI power on, the *INPUT RF* is always selected.

IEC/IEEE-bus command: `DIAG:SERV:INP RF`

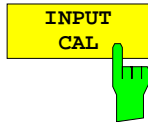

The *INPUT CAL* softkey switches the RF input of the ESPI to the internal calibration source (128 MHz) and activates the data entry of the output level of the calibration source. Possible values are 0 dB and -30 dB.

IEC/IEEE-bus command: `DIAG:SERV:INP CAL;`

`DIAG:SERV:INP:CSO 0 DBM`



The *ENTER PASSWORD* softkey allows the entry of a password.

The ESPI contains a variety of service functions which, if incorrectly used, can affect correct operation of the receiver. These functions are normally not accessible and are only usable after the entry of a password (see instrument service manual).

IEC/IEEE-bus command: `SYST:PASS "Password"`

SETUP SERVICE NEXT submenu:

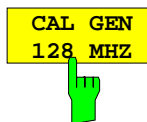

The *CAL GEN 128 MHZ* softkey selects a sinusoidal signal at 128 MHz as output signal for the internal calibration source. The internal pulse generator will be switched off.

CAL GEN 128 MHZ is the default setting of the ESPI.

IEC/IEEE-bus command: `DIAG:SERV:INP:PULS OFF`



The *PULSE xx* softkey switches the selected pulse generator on.

IEC/IEEE-bus command: `DIAG:SERV:INP CAL`  
`DIAG:SERV:INP:PULS ON;`  
`DIAG:SERV:INP:PRAT 2 MHZ`

## Selftest

SETUP SERVICE submenu:



The *SELFTEST* softkey initiates the selftest of the instrument modules.

With this function the instrument is capable of identifying a defective module in case of failure.

During the selftest a message box appears in which the current test and its result is shown. The test sequence can be aborted by pressing ENTER ABORT.

All modules are checked consecutively and the test result (selftest PASSED or FAILED) is output in the message box.

IEC/IEEE-bus command:        \*TST?



The *SELFTEST RESULTS* softkey calls the *SELFTEST* table in which the results of the module test are displayed.

In case of failure a short description of the failed test, the defective module, the associated value range and the corresponding test results are indicated.

SELFTEST			
SELFTEST: FAILED		24.APR.1999 14:25	
		Service level: 0	
TEST	RESULT	VALID RANGE	VALUE
Voltages	OK		
Pretune DAC	OK		
Synthesizer	FAIL		
Frontend2 128MHz Ref unlock	FAIL	1.25V...3.5V	1.14V
Frontend1 384MHz Ref Input	OK	0.5...0.6V	0V
Signal Path	OK		

IEC/IEEE-bus command:        DIAG:SERV:STE:RES?

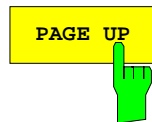

The *PAGE UP* or *PAGE DOWN* softkey sets the *SELFTEST RESULTS* table to the next or previous page.

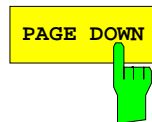

IEC/IEEE-bus command        --

## Hardware Adjustment

Some of the ESPI modules can be re-aligned. This re-alignment can become necessary after calibration due to temperature drift or aging of components (see service manual instrument).



### Caution:

*The re-alignment should be carried out by qualified personnel since the changes considerably influence the measurement accuracy of the instrument. This is the reason why the softkeys REF FREQUENCY, CAL SIGNAL POWER and SAVE CHANGES can only be accessed after entering a password.*

## Firmware Update

The installation of a new firmware version can be performed using the built-in diskette drive. The firmware update kit contains several diskettes.

The installation program is called in the *SETUP* menu.

*SETUP* side menu:

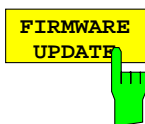

The *FIRMWARE UPDATE* softkey starts the installation program and leads the user through the remaining steps of the update

IEC/IEEE-bus command:      --

The firmware update is started as follows:

Insert disk 1 into the floppy drive.

Call *SETUP* side menu via [*SETUP*][*NEXT*]

Start the update via [*FIRMWARE UPDATE*]

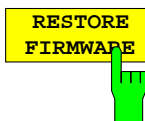

The *RESTORE FIRMWARE* softkey restores the previous firmware version

IEC/IEEE-bus command:      --

## Saving and Recalling Data Sets – FILE Key

The *FILE* key calls the following functions:

- Storage/loading functions for storing (*SAVE*) instrument settings such as instrument configurations (measurement/display settings, etc.) and measurement results from working memory to permanent storage media, or to load (*RECALL*) stored data into working memory.
- Functions for management of storage media (*FILE MANAGER*). Included are among others functions for listing files, formatting storage media, copying, and deleting/rename files.

The ESPI is capable of internally storing complete instrument settings with instrument configurations and measurement data in the form of data sets. The respective data are stored on the internal hard disk or, if selected, on a floppy. The hard-disk and floppy-disk drives have the following names:

floppy disk      A:  
 hard disk        D: (hard disk C: is reserved for instrument software)

In addition to the saving and recalling of complete instrument settings, it is also possible to save/recall subsets of settings. Configuration data and measurement values are stored in separate files. These files have the same name as the data set but however have a different extension. A data set thus consists of several files which have the same name but different extensions (see Table 4-3). Default setting for storing the data sets is directory D:\USER\CONFIG.

When saving or loading a data set, the subsets which are to be saved or loaded can be selected in the corresponding tables. This makes it easy to reconstruct specific instrument settings beside the default setting of the instrument. When saving and loading data, data subsets are selected in table *SEL ITEMS TO SAVE/RECALL*.

The saved files of the data sets can be copied from one storage medium (e.g. drive C:) to another storage medium (e.g. drive A:) or to another directory using the functions found in the *FILE MANAGER* sub menu. File names and extensions must however not be changed. The relationship between the data subsets and the extensions is shown in Table 4-3.

Table 4-3 Relationship between extensions, contents and designations of data subsets

	Designation in the table SEL ITEMS TO SAVE/RECALL	Contents	Extension
Configuration data:	CURRENTSETTINGS	current settings of the measurement hardware and the related title, if present	.SET
		active limit lines	.LIN
		current configuration of general instrument parameters	.CFG
		configuration for hardcopy output	.HCS
		tracking generator settings (only with option tracking generator)	.TCI
		active transducer set active transducer factors	.TS .TF
	PEAK/FINAL LIST	peak list or final measurement results	.LIN
Additional configuration data	ALL LIMIT LINES	all limit lines	.LIA
	SOURCE CAL DATA	Settings for source calibration (only with option tracking generator)	.TS1 .TS2
		Correction data for source calibration (only with option tracking generator)	.TC1 .TC2
	ALL TRANSDUCERS	all transducer sets and transducer factors	.TSA .TFA
Measurement results:	ALL TRACES	measurement data trace 1 to trace 3, screen A	.TR1 to TR3
		measurement data trace 1 to trace 3, screen B	.TR4 to TR6

## Saving a Data Set

- Select the data subsets to be saved (sub-menu *ITEMS TO SAVE/RCL* (configurations, measurement and calibration data) (softkey *ITEMS TO SAVE/RCL*).
- Possibly enter a comment (softkey *EDIT COMMENT*)
- Enter the directory in which the data set should be saved in table *SAVE DATA SET* (softkey *SAVE*).
- Enter the name of the data set which should be saved (softkey *SAVE*) and save the data set by pressing the *ENTER* key.

Data set names may contain both letters and numbers, in the simplest case only numbers.

If required, the desired directory can be given a prefix to the data set name (the directory is then automatically set for further *SAVE* and *RECALL* operations).

The simplest example for the input of a data set name is illustrated by the following key strokes:

<SAVE> <1> <units key>

**Note:** *If the current instrument configuration is to be stored under an existing name, a selection list is available via the *DATA SET LIST* softkey. The storage is performed as follows.*

- *Press a units key after selecting a data set in table *DATA SET LIST*  
The name and the selection of the data subsets for the currently selected data set will be placed in the *SAVE DATA SET* table.*
- *Press the *SAVE* softkey.  
The entry field *EDIT NAME* with the name of the selected data set is opened.*
- *Press a units key.  
The current instrument configuration is saved as a data set under this name.*

## Recalling a Data Set:

The data set can be loaded in two ways:

### 1. Direct entry of the data name:

- Select data subsets which should be loaded (configurations, measurement and calibration data) with softkey *ITEMS TO SAVE/RCL* in sub menu *ITEMS TO SAVE/RCL*).
- Enter the name of the data set to be saved (softkey *RECALL*) and recall the data set by pressing the *ENTER* key).

Data set names may contain both letters and numbers, in the simplest case only numbers. If required, the desired directory can be prefixed to the data set name (the directory is then automatically set for further *SAVE* and *RECALL* operations).

The simplest example for the input of a data set name is illustrated by the following key strokes: <RECALL> <1> <units key>

### 2. Selecting the data set from a selection list:

- Select from submenu *ITEMS TO SAVE/RCL* the data subsets which should be loaded (configurations, measurement and calibration data) (softkey *ITEMS TO SAVE/RCL*).
- Select the data set which should be loaded (Softkey *DATA SET LIST*) and confirm with *ENTER*. The data set is taken over in the *RECALL DATA SET* table.
- Press the *RECALL* softkey. The entry field for the data set name is opened and contains the desired data set.
- Initiate the loading of the selected data set by pressing the *ENTER* key.



**Note:** If the set directory does not correspond to the required directory for loading, it can be changed as follows:

- Press the RECALL softkey.
- Close the entry field for the data set name with ESC.
- Select the PATH filed with the cursor keys.
- Open the entry field for the directory name with ENTER.
- Enter the directory name and confirm with ENTER.

Then proceed with the selection list as described above.

Any settings not restored when data subsets are loaded will remain unchanged in the instrument. During recall operations, the ESPI recognises which subsets are present in the recalled data set and ignores selected data subsets that are not available.

## FILE Menu

FILE menu

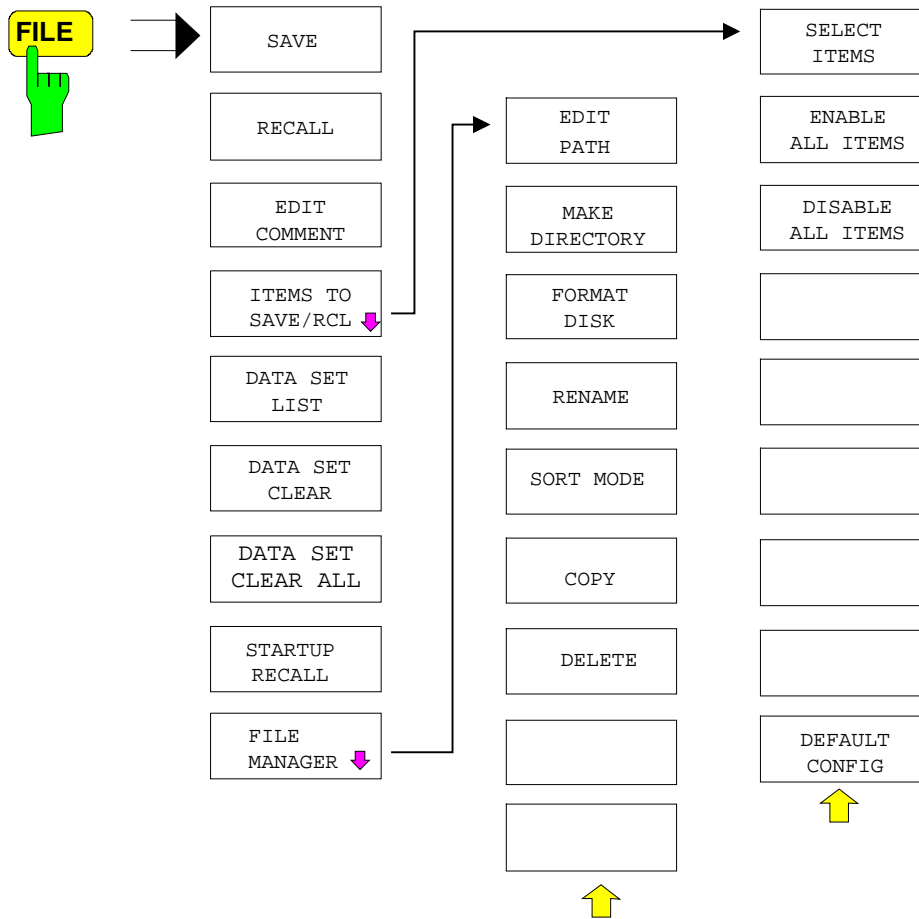

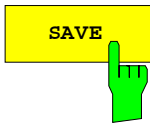

The *SAVE* softkey activates table *SAVE DATA SET*. The data set is stored by pressing the *ENTER* key.

SAVE DATA SET		
NAME:	DATASET1	PATH:D:\USER\CONFIG ITEMS: DEFAULT
COMMENT:	R	
EDIT NAME		
DATASET1_		

The *SAVE DATA SET* table contains the entry fields for editing the data set:

- Name* name of data set  
The name can be entered with or without drive name and directory; the drive name and directory, if available, are then taken over in the *PATH* field. The extension of the data name is ignored.
- Path* directory in which the data set will be saved
- Items* indicates whether the default selection of the data subset (DEFAULT) or a user-defined selection (SELECTED) will be saved
- Comment* Commentary regarding the data set

IEC/IEEE command: MMEM:STOR:STAT 1,"a:\test02"

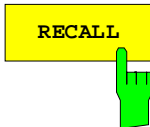

The *RECALL* softkey activates the entry of the path in which the data set is located. The data set is recalled by pressing the *ENTER* key.

RECALL DATA SET		
NAME:	DATASET1	PATH:D:\USER\CONFIG ITEMS: DEFAULT
COMMENT:	R	
EDIT NAME		
DATASET1_		

The *RECALL DATA SET* table shows the current settings regarding the data set:

- Name* name of data set
- Path* directory in which the data set is located
- Items* indicates whether the default selection of the data subset (DEFAULT) or a user-defined selection (SELECTED) will be recalled
- Comment* Commentary regarding the data set

IEC/IEEE command: MMEM:LOAD:STAT 1,"a:\test02"

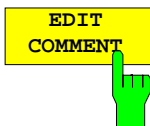

The *EDIT COMMENT* softkey activates the entry of commentary concerning the current data set. A total of 60 characters are available for this purpose.

IEC/IEEE command: MMEM:COMM "Setup fuer GSM Messung"

The *SEL ITEMS TO SAVE/RCL* softkey opens a sub-menu for selection of the data subsets.

*FILE - ITEMS TO SAVE/RCL* sub-menu:

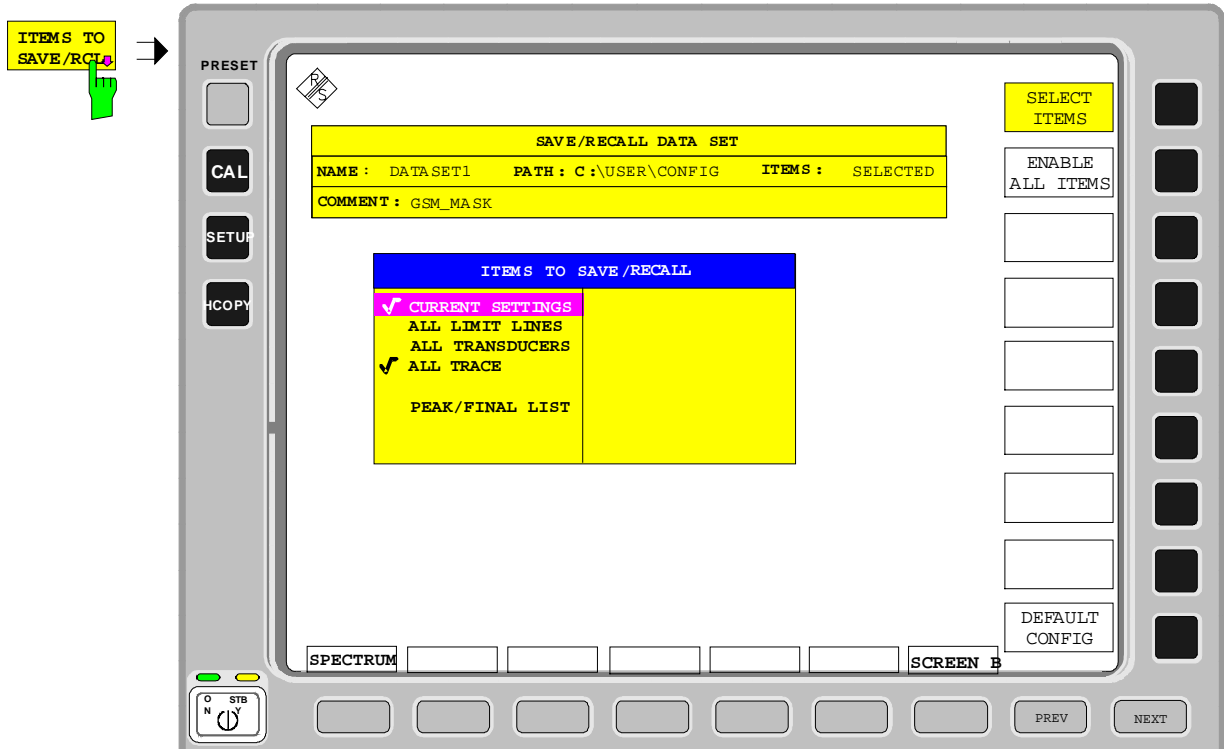

The *ITEMS TO SAVE/RECALL* table offers the following selectable data subsets:  
*Current Settings* these settings include:

- current configuration of general instrument parameters
- current measurement hardware settings
- active limit lines:  
 A data set may contain maximum 8 limit lines for each window. It always contain the activated limit lines and the de-activated limit lines used last, if any. Consequently, the combination of the restored de-activated limit lines depends on the sequence of use with command `MMEM:LOAD`.
- user-defined color settings
- configuration for hardcopy output
- active transducer:  
 A data set may contain maximum 4 transducer factors. It always contain the activated factors and the factors used and de-activated last, if any. Consequently, the combination of the restored de-activated transducer factors depends on the sequence of use with the command `MMEM:LOAD`.
- peak list or final measurement results (receiver mode)
- Settings of tracking generator (only with option tracking generator)

*All Limit Lines*  
*All Transducers*  
*All Traces*  
*Source Cal Data*

all limit lines  
 all transducer  
 all traces which are not blanked  
 correction data for tracking generator (only with option tracking generator)

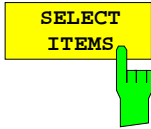

The *SELECT ITEMS* softkey moves the selection bar to the first line, left column of the table. An entry is selected by pressing the *ENTER* key in the desired line. The selection is cleared by pressing the key again.

IEC/IEEE command:

- Current Settings: MMEM:SEL:HWS ON
- All Limit Lines: MMEM:SEL:LIN:ALL ON
- All Traces: MMEM:SEL:TRAC ON
- Source Cal Data: MMEM:SEL:SCD ON
- All Transducers: MMEM:SEL:TRAN:ALL ON
- Peak/Final List: MMEM:SEL:FIN ON

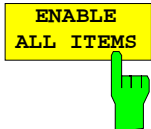

The *ENABLE ALL ITEMS* softkey marks all entries in the table.

IEC/IEEE command: MMEM:SEL:ALL

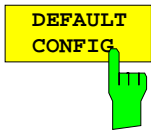

The *DEFAULT CONFIG* softkey establishes the default selection of the data subset to be saved and outputs *DEFAULT* in the *ITEMS* field of the *SAVE/RECALL DATA SET* table.

IEC/IEEE command: MMEM:SEL:DEF

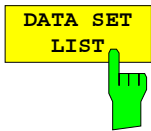

The *DATA SET LIST* softkey opens the *DATA SET LIST/CONTENTS* table. In addition, the *DATA SET CLEAR* and *DATA SET CLEAR ALL* softkeys are displayed.

DATA SET LIST	DATA SET CONTENTS				
DATASET 1 DATASET 2 DATASET 3	<table border="1" style="width: 100%;"> <thead> <tr> <th style="background-color: #D3D3D3;">CONTENTS</th> </tr> </thead> <tbody> <tr> <td>                             ✓ CURRENT SETTINGS                              ALL LIMIT LINES                              ALL TRANSDUCERS                              ✓ ALL TRACES                              SOURCE CAL DATA                              PEAK/FINAL LIST                         </td> </tr> <tr> <th style="background-color: #D3D3D3;">COMMENT</th> </tr> <tr> <td>GSM_MASK</td> </tr> </tbody> </table>	CONTENTS	✓ CURRENT SETTINGS ALL LIMIT LINES ALL TRANSDUCERS ✓ ALL TRACES SOURCE CAL DATA PEAK/FINAL LIST	COMMENT	GSM_MASK
CONTENTS					
✓ CURRENT SETTINGS ALL LIMIT LINES ALL TRANSDUCERS ✓ ALL TRACES SOURCE CAL DATA PEAK/FINAL LIST					
COMMENT					
GSM_MASK					

The *DATA SET LIST* column lists all of the data sets which are stored in the selected directory.

The *CONTENTS* and *COMMENT* lines in the *DATA SET CONTENTS* column indicate the saved data subsets and the comment for the currently selected data set. A '✓' prefixed to a data subset means that the latter is available in the instrument but that it has not been selected (see *SELECT ITEMS* softkey).

IEC/IEEE command: ---

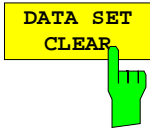

The *DATA SET CLEAR* softkey deletes the selected data set  
 IEC/IEEE command: `MMEM:CLE:STAT 1, "test03"`

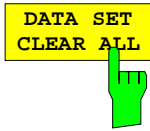

The *DATA SET CLEAR ALL* softkey deletes all data sets in the current directory.  
 Since, in this case, all available data sets are lost, confirmation by the user is required.

IEC/IEEE command: `MMEM:CLE:ALL`

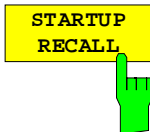

The *STARTUP RECALL* softkey activates the selection of a data set which is automatically loaded when the instrument is powered on. For that purpose the table *DATA SET LIST/CONTENT* is opened (analog to *DATA SET LIST*).

DATA SET LIST	DATA SET CONTENTS
DATASET 1 DATASET 2 DATASET 3	CONTENTS <input checked="" type="checkbox"/> CURRENT SETTINGS ALL LIMIT LINES ALL TRANSDUCERS <input checked="" type="checkbox"/> ALL TRACES SOURCE CAL DATA
	COMMENT
	GSM_MASK

The *DATA SET LIST* column displays all data sets present in the selected directory

The *CONTENTS* and *COMMENT* lines in the *STARTUP RECALL* column indicate the saved data subsets and the commentary for the currently selected data set.

In addition to the data sets stored by the user, the data set *FACTORY*, which specifies the settings of the instrument before it was last switched off (Standby), is always present.

If a data set other than *FACTORY* is chosen then, at the time of instrument power on, the available data subsets of the selected data set are recalled. The data subsets which are not present in this data set are taken from the *FACTORY* data set.

**Note:** *The specified data set is also loaded upon PRESET if STARTUP RECALL is active. The preset settings can thus be arbitrarily modified.*

IEC/IEEE command: `MMEM:LOAD:AUTO 1, "D:\user\config\test02"`

The *FILE MANAGER* softkey opens a menu for managing storage media and files.

*FILE - FILE MANAGER* sub-menu:

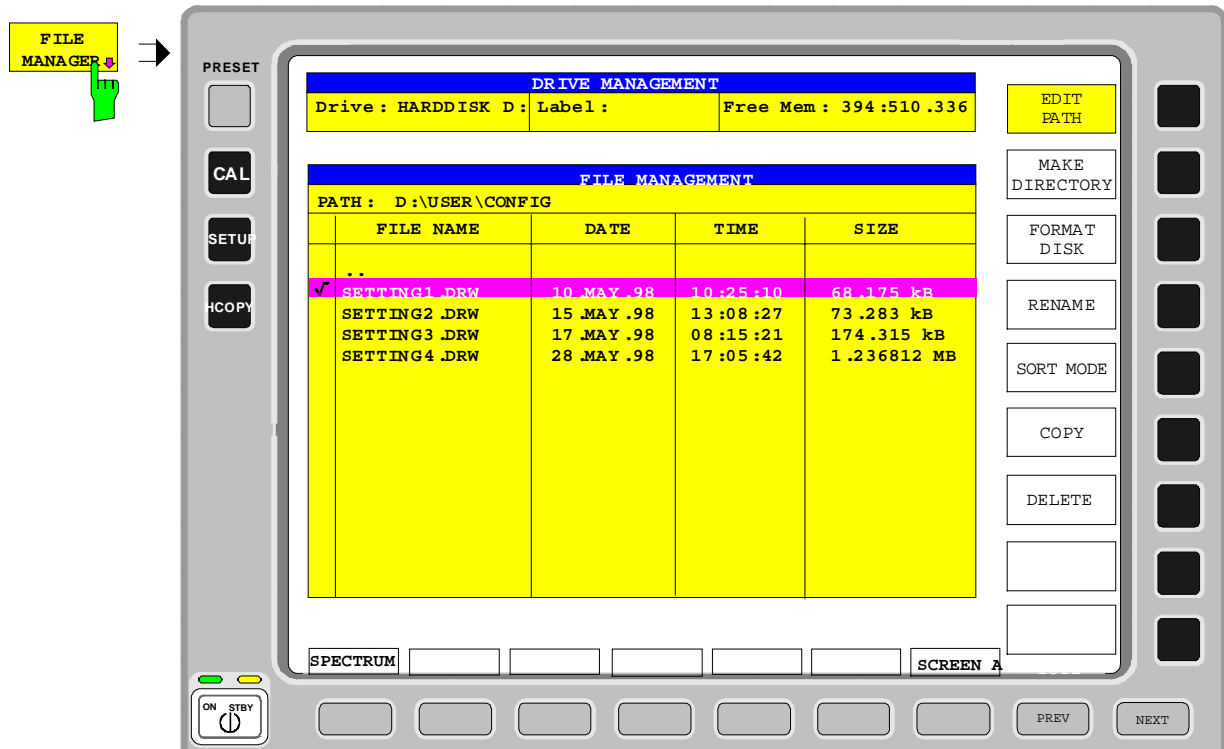
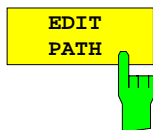

Table *Drive Management* displays the name and label of the storage medium as well as the available storage area.

Table *File Management* displays the files of the current directory and indicates if any subdirectories are present.

If a directory name is selected, the ESPI automatically changes to this directory. Selection of the entry '..' moves the ESPI to the next higher directory level.

**Note:** *It is not possible to change menus as long as a file operation is running.*



The *EDIT PATH* softkey activates the input of the directory which will be used in subsequent file operations.

The new path is included in the *FILE MANAGEMENT* table.

IEC/IEEE command:    MMEM:MSIS "a:"  
                           MMEM:CDIR "D:\user "

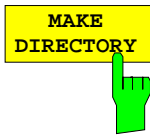

The *MAKE DIRECTORY* softkey creates directories/sub-directories. Sub-directories are recommended for sorting files on the storage medium so that the structure is easier to comprehend.

The entry of an absolute path name (e.g.; "\USER\MEAS") as well as the path relative to the current directory (e.g., "..\MEAS") is possible.

IEC/IEEE command: `M MEM:MDIR "D:\user\test"`

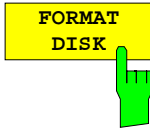

The *FORMAT DISK* softkey formats diskettes located in drive A:. To prevent accidental destruction of diskette data, confirmation by the user is requested.

IEC/IEEE command: `M MEM:INIT "a:"`

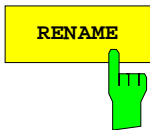

The *RENAME* softkey activates the entry of a new name for the selected file or directory.

IEC/IEEE command: `M MEM:MOVE "test02.cfg", "set2.cfg"`

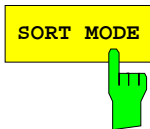

The *SORT MODE* softkey activates the selection of the criteria according to which the files listed in the *FILE MANAGEMENT* table may be sorted.

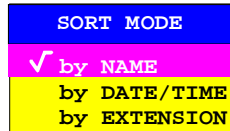

Directory names are located at the top of the list after the entry for the next higher directory level ("..").

IEC/IEEE command: `--`

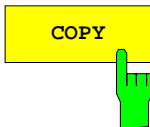

The *COPY* softkey activates the input of the destination of the copy operation.

By entering a predefined disk drive (e.g. C:), a file can also be copied to another storage medium. The files/directories selected by the cursor are copied after the input is confirmed by pressing the *ENTER* key.

IEC/IEEE command: `M MEM:COPY "D:\user\set.cfg", "a:"`

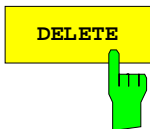

The *DELETE* softkey deletes the selected files. To prevent accidental deletion of data, confirmation by the user is requested.

IEC/IEEE command: `M MEM:DEL "test01.hcp"`  
`M MEM:RDIR "D:\user\test"`

# Measurement Documentation – HCOPIY Key

**Note:** The installation of additional printers is described in chapter 1, section "Installation and Configuration of Printers".

Pressing one of the softkeys *PRINT...* in the *HCOPIY* menu initiates the print job. The printer parameters defined in the *DEVICE SETTINGS* menu are used for setting up the printer configuration. All of the display items to be printed are written to the printer buffer. Since the printer runs in the background, the instrument may be operated immediately after pressing the *PRINT...* softkey.

With *PRINT SCREEN* selected, all the diagrams with traces and status displays are printed as they occur on the screen. Softkeys, open tables and data entry fields are not printed out. Function *PRINT TRACE* allows printing out individual traces. With *PRINT TABLE* tables can be printed out.

If the *PRINT TO FILE* option in the *DEVICE SETTINGS* table is selected the printout is directed to a file. Upon pressing one of the softkeys *PRINT...*, the file name to which the output data are to be written is requested. For this an entry field is opened for entering the file name.

While a print job is in progress, problems may occur in the output device. If, while printing, the output device issues a *PAPER OUT* message, i.e., no more paper is available, the user will be prompted by the following message

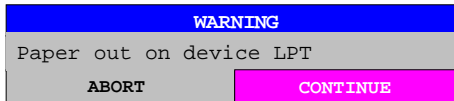

to load paper into the output device. The print job will then be either continued (*CONTINUE* selected) or aborted (*ABORT* selected).

Similar *SYSTEM MESSAGES* appear if the printer is offline, etc.

The *HARDCOPY ABORT* softkey aborts a print job in progress.

HCOPIY menu:

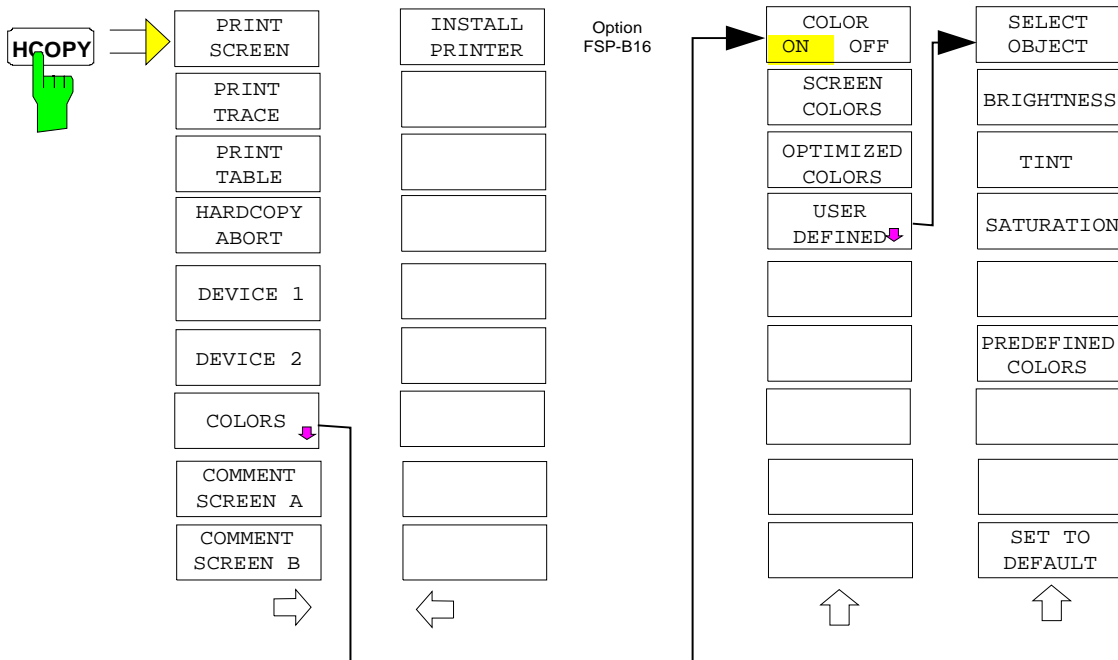



The *HCOPY* key opens the *HARDCOPY* menu for starting and configuring the printout.

The *PRINT SCREEN*, *PRINT TRACE* and *PRINT TABLE* softkeys start the desired printout, which can be aborted with *HARDCOPY ABORT*.

Selection and configuration of the output interface is performed via the *DEVICE 1* and *2* softkeys.

Selection between b/w and colored printouts is possible in submenu *COLORS* provided that the printer connected is able to output such prints. The colors of the printout correspond to those of the screen, i.e. a yellow trace will be output in yellow.

To change the colors of the objects on the printout, the screen colors have to be changed correspondingly in menu *DISPLAY*, submenu *CONFIG DISPLAY*. One exception is the color of the background and of the grid. The output background is always white irrespective of the screen color and the grid is always black.

Selection between b/w (default) and colored printouts is possible in submenu *COLORS* provided that the printer connected is able to output such prints. Additionally the color settings can be made:

- **SCREEN**                      Output in screen colors
- **OPTIMIZED (default)**    Instead of the bright screen colors darker colors are used for traces and markers: trace 1 blue, trace 2 black, trace 3 green, marker turquoise.
- **USER DEFINED**            All colors can be defined by the user. The items for which the colors can be defined are the same as in menu *DISPLAY – CONFIG DISPLAY – NEXT*.

**Notes:**

- For *SCREEN* and *OPTIMIZED*, the output background is always white and the grid is always black. For *USER DEFINED*, also the background and grid colors can be defined.
- The screen colors are switched to the selected print colors when calling the submenu; they are restored again when leaving the submenu.

The *COMMENT SCREEN A* and *COMMENT SCREEN B* softkeys are available for adding comments to the *hardcopy* (date and time are automatically added).

With the *INSTALL PRINTER* softkey other printer drivers can be installed.

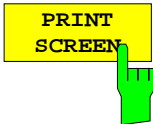

The *PRINT SCREEN* softkey starts the output of test results.

All the diagrams, traces, markers, marker lists, limit lines etc. are printed out as long as they are displayed on the screen. All the softkeys, tables and open data entry fields are not printed out. Moreover, comments, title, date, and time are output at the bottom margin of the printout .

IEC/IEEE-bus command:    *HCOP : ITEM : ALL*  
     *HCOP : IMM*

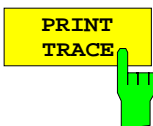

The *PRINT TRACE* softkey starts the output of all curves visible on the display screen without auxiliary information. Specifically, no markers or display lines are printed.

IEC/IEEE-bus command:    *HCOP : ITEM : WIND : TRAC : STAT ON*  
     *HCOP : IMM*

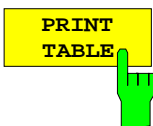

The *PRINT TABLE* softkey starts the output of all tables and info lists visible on the display screen without the measurement diagrams and other information lying behind.

IEC/IEEE-bus command:    *HCOP : ITEM : WIND : TABL : STAT ON*  
     *HCOP : IMM*

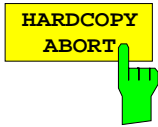

The *HARDCOPY ABORT* softkey aborts the printout.

IEC/IEEE-bus command: ABOR

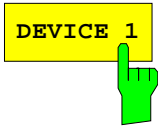

The *DEVICE 1/DEVICE 2* softkey determines the active output device. Table *HARDCOPY DEVICE SETTINGS* is simultaneously opened for the configuration of the two possible devices. The selection bar marks the selected line of the table.

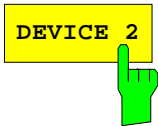

HARDCOPY DEVICE SETTINGS	
Device1	WINDOWS METAFILE
Print to File	YES
Orientation	---
Device2	CLIPBOARD
Print to File	---
Orientation	---

*Device 1/2* In this lines, the selection of the output device/language for Device1 or Device2 is made.

*Print to File* selects printout to file or printer

*Orientation* selects the print format of the output page

**Device 1/ Device 2**

The selection of the output device/language for *Device 1* and *Device 2* is made in this line. After pressing the *ENTER* key, the list of all installed printers is displayed. Three file formats and the Windows NT clipboard are also available:

- CLIPBOARD output in Windows NT clipboard.
- WINDOWS METAFILE or BITMAP FILE output in file
- ENHANCED METAFILE output in file or Windows NT clipboard.

HARDCOPY DEVICE SETTINGS	
Device1	WINDOWS METAFILE
Print to File	YES
Orientation	---
Device2	CLIPBOARD
Print to File	---
Orientation	---

DEVICE
<input checked="" type="checkbox"/> CLIPBOARD
WINDOWS METAFILE
ENHANCED METAFILE
BITMAP FILE
HP DeskJet 660C

The installation of additional printers is described in chapter 1, section "Installation and Configuration of Printers".

**Notes:** *Selecting the type of printer automatically sets the parameters PRINT TO FILE and ORIENTATION to values which correspond to a standard mode with this output device. Other printer-dependent parameters, such as PAPERSIZE, can be modified under Windows NT in the printer properties window (START/SETTINGS/PRINTER/SETTINGS). For operation of Windows NT, a mouse and an external keyboard have to be connected to instrument (see also Section "Installation and Configuration of Printers")*

IEC/IEEE-bus command:

```
HCOP:DEV:LANG GDI;
SYST:COMM:PRIN:ENUM:FIRS?;
SYST:COMM:PRIN:ENUM:NEXT?;
SYST:COMM:PRIN:SEL 'HP Deskjet 660 on LPT1';
HCOP:DEST "SYST:COMM:PRIN"
```

**Print to File**

In this line, directing the printout to the printer (OFF) or to a file (ON) is selected. For printout to a file, the user is prompted to enter a file name on starting the print.

Selecting the type of printer automatically sets this parameter to the value which corresponds to a standard mode with this output device.

```
IEC/IEEE-bus command: HCOP:DEST "SYST:COMM:PRIN" or
HCOP:DEST "SYST:COMM:MMEM"
```

**Orientation**

In this line, the print format of the output page is set to either vertical (= PORTRAIT) or horizontal (= LANDSCAPE).

```
IEC/IEEE-bus command: HCOP:PAGE:ORI PORT
```

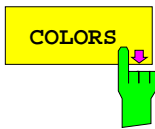

The *COLORS* softkey opens the submenu for selection of the print colors (see section "*Selection of Print Colors*" below).

IEC/IEEE-bus command: -



The *COMMENT SCREEN A* or *B* softkey opens an entry field in which a comment of two lines (60 characters per line) can be entered for screen A or B.

If the user enters more than 60 characters, the excess characters appear on the second line on the print-out. At any point, a manual line-feed can be forced by entering the @ character.

The comment is printed below the corresponding diagram. The comment text appears on the print-out, but does not appear on the display screen.

If a comment is not to appear on the printout, it has to be deleted.

By pressing *PRESET*, all comments will be deleted.

IEC/IEEE-bus command: `HCOP:ITEM:WIND2:TEXT 'Comment'`



*HCOPY* side menu:

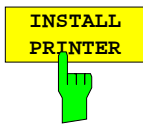

A certain number of printer drivers is already installed on the ESPI. The *INSTALL PRINTER* softkey opens the "Printers" window where further printer drivers can be installed (see section "Installation of a local printer" and "Installation of Network Printer").

IEC/IEC-bus command: -

## Selection of Print Colors

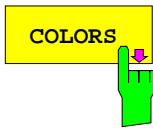

The *COLORS* softkey opens the submenu for setting the print colors. In order to simplify color selection, the screen colors are switched to the selected print colors when opening the submenu and they are restored again when leaving the submenu.

IEC/IEC-bus command: -

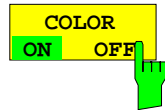

The *COLOR ON OFF* softkey switches between b/w and colored printouts. All colored areas are output white irrespective of the screen color and all lines are output black in order to improve the contrast of the printout. Default is *COLOR ON*.

IEC/IEC-bus command: `HCOP:DEV:COL ON`

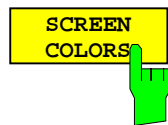

The *SCREEN COLORS* softkey selects the current screen colors as print colors.

**Note:**

*The output background is always and the grid is always black.*

IEC/IEC-bus command: `HCOP:CMAP:DEF1`



The *OPTIMIZED COLORS* softkey activates a color scheme which has been selected to give optimum visibility of all print elements

Trace 1 is printed blue, trace 2 black, trace 3 green and the markers turquoise.

All other colors correspond to the screen colors as selected with softkey *DISP-CONFIG DISPLAY-DEFAULT COLORS 1*.

**Note:**

*The output background is always and the grid is always black.*

IEC/IEC-bus command: `HCOP:CMAP:DEF2`

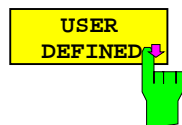

The *USER DEFINED* opens the submenu for defining the colors.

IEC/IEC-bus command: `HCOP:CMAP:DEF3`

USER DEFINED COLORS submenu.

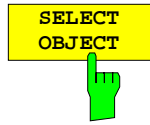

The *SELECT OBJECT* softkey activates the *SELECT PRINT OBJECT* table, with which a print element can be selected. After selection, the color, the brightness, tint and saturation of the selected element can be changed using the softkeys of the same name.

SELECT    PRINT    OBJECT
Background
Grid
Function field + status field + data entry text
Function field LED on
Function field LED warn
Enhancement label text
Status field background
Trace 1
<b>Trace 2</b>
Trace 3
Bargraph PK+
Bargraph PK-
Bargraph quasipeak
Bargraph average
Bargraph RMS
Bargraph final measurement
Marker
Lines
Measurement status + limit check pass
Limit check fail
Table + softkey text
Table + softkey background
Table selected field text
Table selected field background
Table + data entry field opaq titlebar
Data entry field opaq text
Data entry field opaq background
3D shade bright part
3D shade dark part
Softkey state on
Softkey state data entry
Logo

IEC/IEC-bus command:                    -



The *BRIGHTNESS* softkey activates entry of the brightness of the selected graphics element.

Values between 0 and 100% can be entered.

IEC/IEC-bus command:  
 HCOP:CMAP5:HSL <hue>,<sat>,<lum>

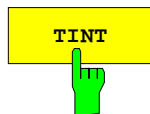

The *TINT* softkey activates the entry of the color tint of the selected print element. The entered value is related to a continuous color spectrum ranging from red (0%) to blue (100%).

IEC/IEC-bus command:  
 HCOP:CMAP5:HSL <hue>,<sat>,<lum>



The *SATURATION* softkey activates the entry of the color saturation for the selected print element.

The range of inputs is from 0 to 100%.

IEC/IEC-bus command:

HCOP:CMAP5:HSL <hue>,<sat>,<lum>



The *PREDEFINED COLORS* softkey activates a table, with which the predefined colors for the selected print element can be set.

COLOR
√ BLACK
BLUE
BROWN
GREEN
CYAN
RED
MAGENTA
YELLOW
WHITE
GRAY
LIGHT GRAY
LIGHT BLUE
LIGHT GREEN
LIGHT CYAN
LIGHT RED
LIGHT MAGENTA

IEC/IEC-bus command:

HCOP:CMAP1 ... 32:PDEF <color>

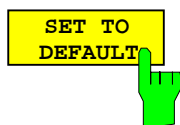

The *SET TO DEFAULT* softkey restores the default color settings (settings of *OPTIMIZED COLORS*).

IEC/IEC-bus command: -

## Tracking Generator - Option FSP-B9

During normal operation (without a frequency offset), the tracking generator emits a signal exactly at the input frequency of the ESPI.

For frequency-converting measurements it is possible to set a constant frequency offset of  $\pm 150$  MHz between the receive frequency of the ESPI and the output signal of the tracking generator. Moreover, an I/Q modulation or AM and FM modulation of the output signal can be provided using two analog input signals.

The output power is level-controlled and can be set in 0.1 dB steps in a range from -30 dBm to 0 dBm.

The tracking generator can be used in all operating modes. Acquisition of test setup calibration values (SOURCE CAL) and normalization using these correction values (*NORMALIZE*) is only possible in the *NETWORK* operating mode.

**Note:** *The RF characteristics of some DUTs is especially sensitive concerning the input VSWR. In such cases insertion of 20 dB attenuation between the DUT and the tracking generator output is highly recommended.*

The tracking generator is activated by means of the NETWORK hotkey in the hotkey bar at the bottom of the screen:

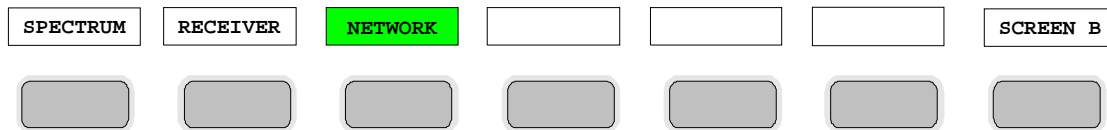



## Tracking Generator Settings

The *NETWORK* hotkey opens a menu for selecting the functions of the tracking generator.

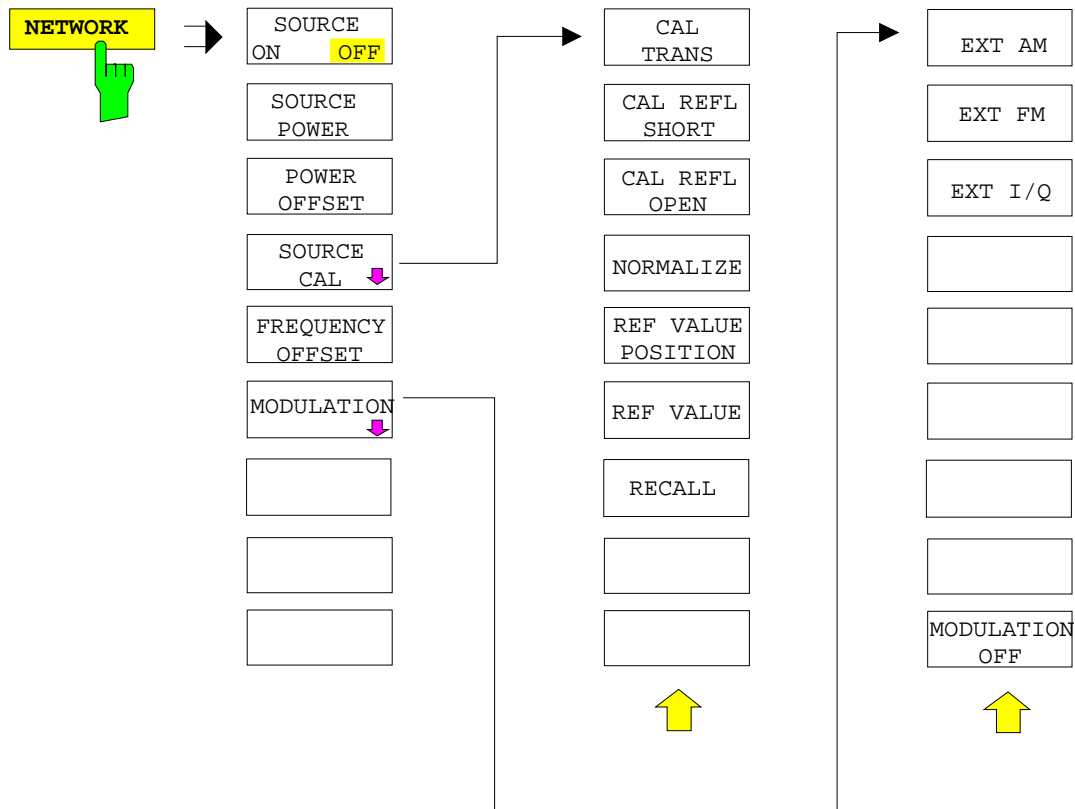

**Note:** Additional softkeys are available in the displayed menus for controlling an external generator if option External Generator Control FSP-B10 is fitted. For detailed information see section 'External Generator Control Option FSP-B10'.

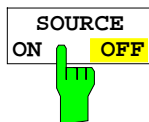

The *SOURCE ON/OFF* softkey switches the tracking generator on or off. Default setting is *OFF*

**Note:**

- When the tracking generator is switched on the maximum stop frequency is limited to 3 GHz. This upper limit is automatically reduced by a frequency offset set up for the tracking generator.
- In order to meet the data sheet accuracy for measurements with active tracing generator the start frequency must be set to  $\geq 3 \times$  Resolution Bandwidth.
- The minimum sweeptime for measurements with data sheet accuracy is 100 ms in frequency domain (span > 0 Hz). Selecting a sweeptime below this limit will result in the sweeptime indicator field SWT being supplied with a red asterisc and the message UNCAL being displayed.
- FFT filters (*FILTER TYPE FFT* in *BW* menu) are not available when the tracking generator is active.

IEC/IEEE-bus command:      `OUTP:STAT ON`

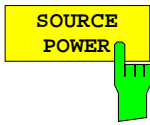

The *SOURCE POWER* softkey allows the tracking generator output power to be selected.

The output level can be set in 0.1 dB steps from -30 dBm to 0 dBm.

If the tracking generator is off, it is automatically switched on when an output power value is entered.

The default output power is -20 dBm.

IEC/IEEE-bus command: `SOUR:POW -20dBm`

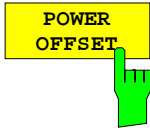

The *POWER OFFSET* softkey allows selection of a constant level offset for the tracking generator.

With this offset for example attenuators or amplifiers at the output connector of the tracking generator can be taken into account for the displayed output power values on screen or during data entry.

The valid range is -200 dB to +200 dB in 0.1 dB steps. Positive offsets apply to an amplifier and negative offsets to an attenuator subsequent to the tracking generator.

The default setting is 0 dB. Offsets  $\neq$  0 will display the enhancement label **LVL**.

IEC/IEEE-bus command: `SOUR:POW:OFFS -10dB`

## Transmission Measurement

This measurement will yield the transmission characteristics of a two-port network. The built-in tracking generator serves as a signal source. It is connected to the input connector of the DUT. The input of the ESPI is fed from the output of the DUT.

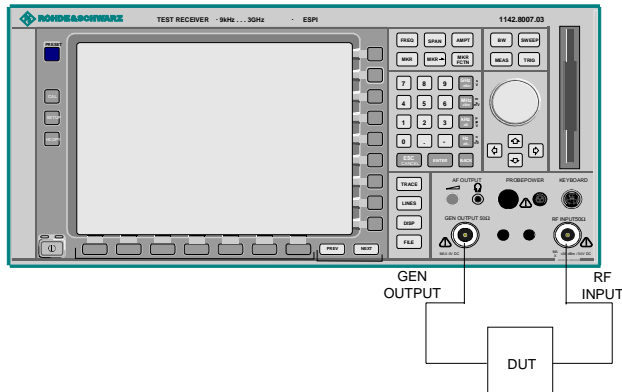
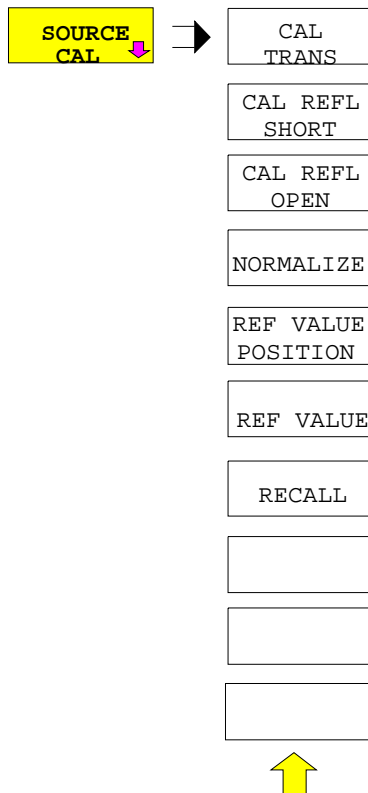

Fig. 4-24 Test setup for transmission measurement

A calibration can be carried out to compensate for the effects of the test setup (eg frequency response of connecting cables).

## Calibration of Transmission Measurement

NETWORK menu:



The *SOURCE CAL* softkey opens a submenu comprising of the calibration functions for the transmission and reflection measurement.

The calibration of the reflection measurement (*CAL REFL...*) and its mechanisms are described in separate sections.

To carry out a calibration for transmission measurements the whole test setup is through-connected (THRU).

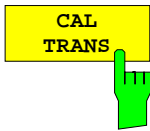

The *CAL TRANS* softkey triggers the calibration of the transmission measurement.

It starts a sweep that records a reference trace. This trace is then used to calculate the difference for the normalized values.

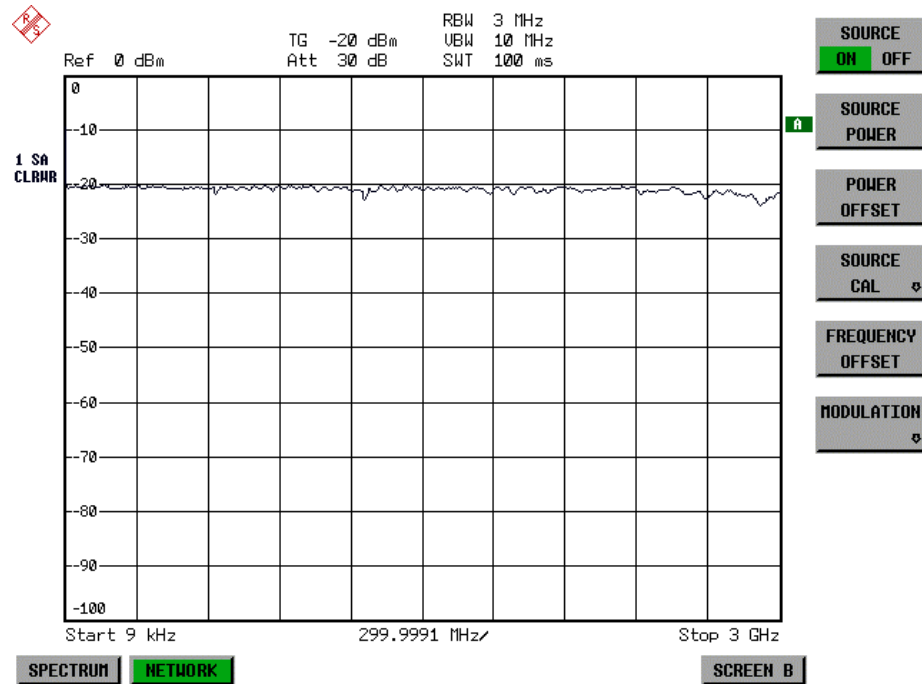
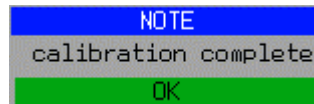

Fig.: 4-25 Calibration curve for transmission measurement

During the calibration the following message is displayed:



After the calibration the following message is displayed:



This message will be cleared automatically after approx. 3 seconds.

IEC/IEEE-bus command: CORR:METH TRAN

## Normalization

NETWORK-SOURCE CAL menu:

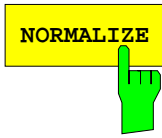

The *NORMALIZE* softkey switches the normalization on or off. The softkey is only available if the memory contains a correction trace.

It is possible to shift the relative reference point within the grid using the *REF VALUE POSITION* softkey. Thus, the trace can be shifted from the upper border of the grid to the vertical center of the grid:

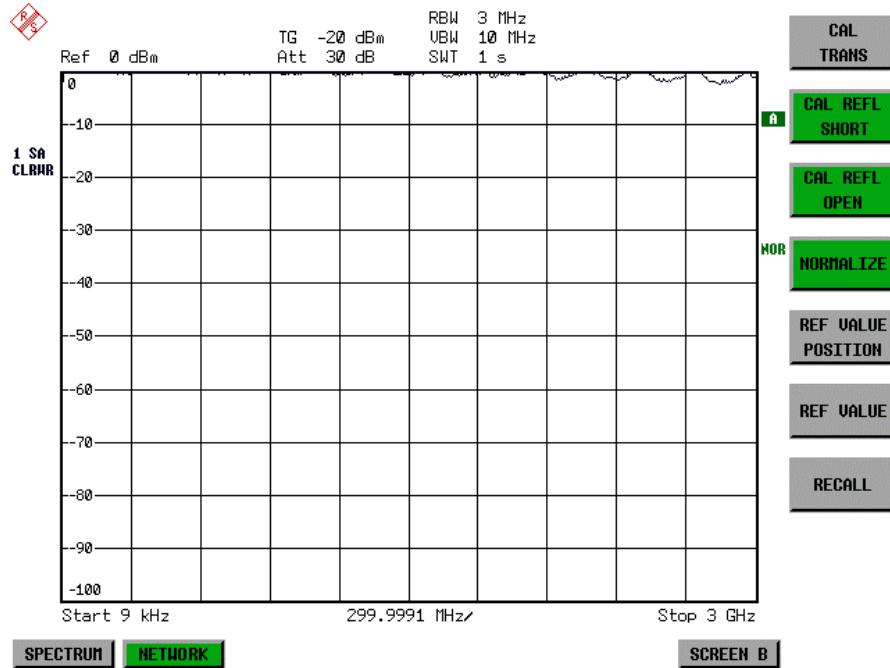

Fig.: 4-26 Normalized display

In *SPLIT SCREEN* operation, the normalization is switched on in the currently active window. Different types of normalization can be active in the two windows.

Normalization is aborted when the *NETWORK* operating mode is quit.

IEC/IEEE-bus command: CORR ON



The *REF VALUE POSITION* softkey marks a reference position in the active window at which the normalization result (calculated difference with a reference trace) is displayed.

If no reference line is active, the softkey switches on a reference line and activates the input of its position. The line can be moved within the grid boundaries.

The reference line is switched off by pressing the softkey again.

The function of the reference line is explained in the section "Calibration mechanisms".

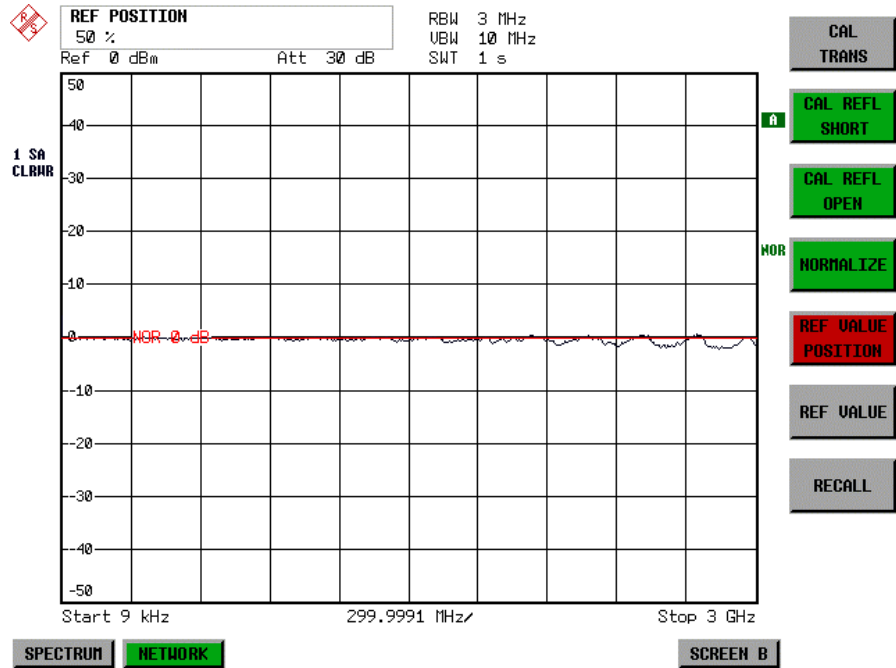
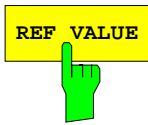

Fig.: 4-27 Normalized measurement, shifted with *REF VALUE POSITION* 50 %

IEC/IEEE-bus command: DISP:WIND:TRAC:Y:RPOS 10PCT



The *REF VALUE* softkey activates the input of a value which is assigned to the reference line.

With default settings the reference line corresponds to a difference of 0 dB between the currently measured trace and the reference trace. Setting the *REF VALUE* to a different value helps to compensate for changes to the level conditions in the signal path after the calibration data have been recorded. If eg after a source calibration a 10 dB attenuation is inserted into the signal path between DUT and ESPI input, the measurement trace will be moved by 10 dB down. Entering a *REF VALUE* of -10 dB will then result in the reference line for difference calculation being moved by 10 dB down as well. This means that the measured trace will be placed on it, as displayed in figure 4-28.

*REF VALUE* always refers to the active window.

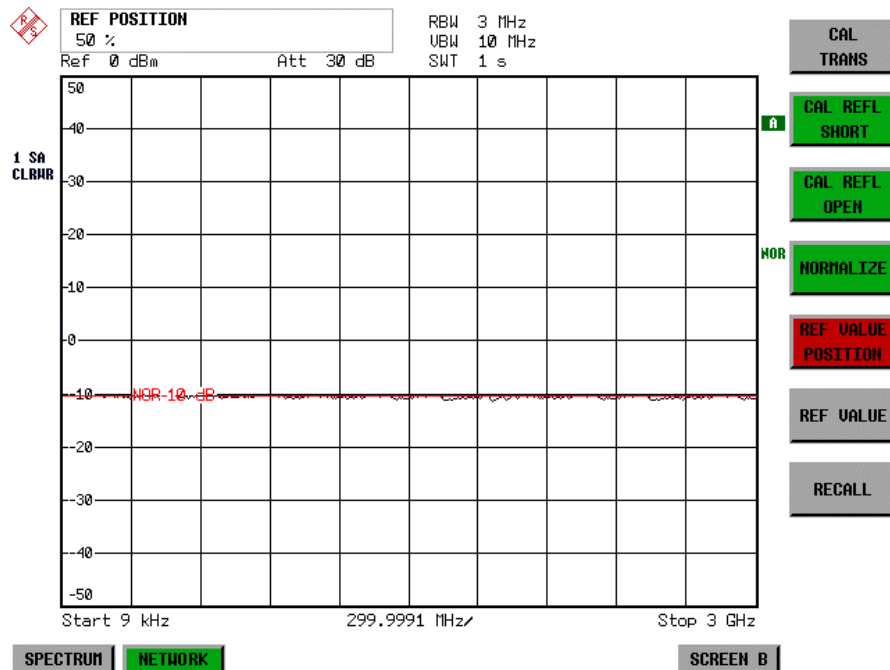

Fig.: 4-28 Measurement with REF VALUE -10 dB and REF VALUE POSITION 50%

After the reference line has been moved by entering a REF VALUE of -10 dB the deviation from the nominal power level can be displayed with high resolution (eg 1 dB/div). The power is still displayed in absolute values, which means that in the above example 1 dB below the nominal power (reference line) = 11 dB attenuation.

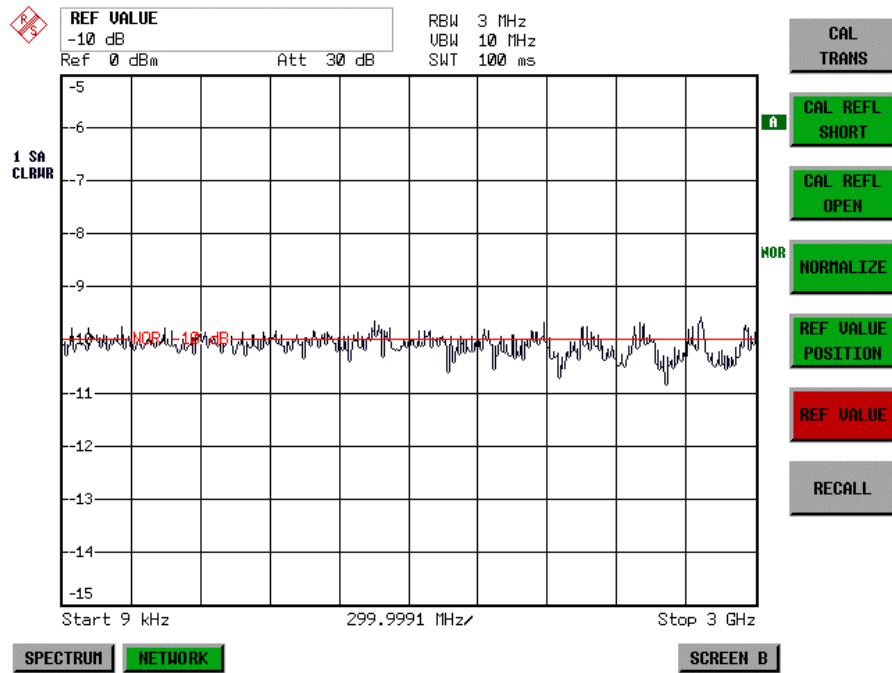
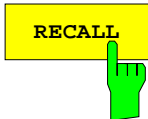

Fig.: 4-29 Measurement of a 10dB attenuator pad with 1dB/DIV

IEC/IEEE-bus command: DISP:WIND:TRAC:Y:RVAL -10dB



The *RECALL* softkey restores the ESPI settings that were used during source calibration.

This can be useful if device settings were changed after calibration (eg center frequency, frequency deviation, reference level, etc).

The softkey is only available if:

- the NETWORK mode has been selected
- the memory contains a calibration dataset.

IEC/IEEE-bus command: CORR:REC



## Reflection Measurement

Scalar reflection measurements can be carried out by means of a reflection-coefficient measurement bridge.

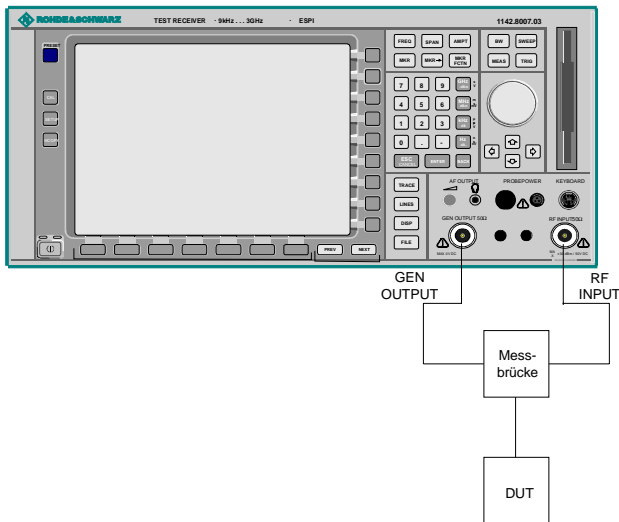
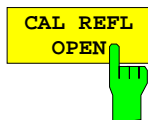

Fig.: 4-30 Test Setup for Reflection Measurement

## Calibration of Reflection Measurement

The calibration mechanism for reflection measurement is basically the same as the one used for transmission measurement.

*NETWORK-SOURCE CAL* submenu



The *CAL REFL OPEN* softkey starts the open-circuit calibration. During calibration the following message is displayed:

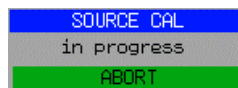

IEC/IEEE-bus command: `CORR:METH REFL`  
`CORR:COLL OPEN`



The *CAL REFL SHORT* softkey starts the short-circuit calibration.

If both calibrations (open circuit, short circuit) are carried out, the calibration curve is calculated by averaging the two measurements and stored in the memory. The order of the two calibration measurements is free.

After the calibration the following message is displayed:

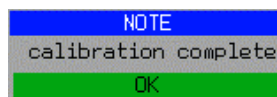

The message is cleared after approx. 3 seconds.

IEC/IEEE-bus command: `CORR:METH REFL`

## Calibration mechanism

Calibration means a calculation of the difference between the currently measured power and a reference curve, independent of the selected type of measurement (transmission/reflection). The hardware settings used for measuring the reference curve are included in the reference dataset.

Even with normalization switched on, the device settings can be changed in a wide area without stopping the normalization. This reduces the necessity to carry out a new normalization to a minimum.

For this purpose the reference dataset (trace with 501 measured values) is stored internally as a table of 501 points (frequency/level).

Differences in level settings between the reference curve and the current device settings are taken into account automatically. If the span is reduced, a linear interpolation of the intermediate values is applied. If the span increases, the values at the left or right border of the reference dataset are extrapolated to the current start or stop frequency, ie the reference dataset is extended by constant values.

An enhancement label is used to mark the different levels of measurement accuracy. This enhancement label is displayed at the right diagram border when normalization is switched on and a deviation from the reference setting occurs. Three accuracy levels are defined:

Table 4-4 Measurement accuracy levels

Accuracy	Enhancement label	Reason/Limitation
High	NOR	No difference between reference setting and measurement
Medium	APX (approximation)	Change of the following settings: <ul style="list-style-type: none"> <li>• coupling (RBW, VBW, SWT)</li> <li>• reference level, RF attenuation</li> <li>• start or stop frequency</li> <li>• output level of tracking generator</li> <li>• frequency offset of tracking generator</li> <li>• detector (max. peak, min. peak, sample, etc.)</li> </ul> Change of frequency: <ul style="list-style-type: none"> <li>• max. 501 points within the set sweep limits (corresponds to a doubling of the span)</li> </ul>
-	Aborted normalization	<ul style="list-style-type: none"> <li>• more than 501 extrapolated points within the current sweep limits (in case of span doubling)</li> </ul>

**Note:** *At a reference level (REF LEVEL) of -10 dBm and at a tracking generator output level of the same value the ESPI operates without overrange reserve, ie the ESPI is in danger of being overloaded if a signal is applied whose amplitude is higher than the reference line. In this case, either the message "OVLD" for overload is displayed in the status line or the display range is exceeded (clipping of the trace at the upper diagram border = Overrange).*

*Overloading can be avoided as follows:*

- *Reducing the output level of the tracking generator (SOURCE POWER, NETWORK menu)*
- *Increasing the reference level (REF LEVEL, AMPT menu)*

## Frequency-Converting Measurements

For frequency-converting measurements (eg on converter units) the tracking generator is able to set a constant frequency offset between the output frequency of the tracking generator and the receive frequency of the ESPI. Up to an output frequency of 150 MHz the measurement can be carried out in both inverted and normal positions.

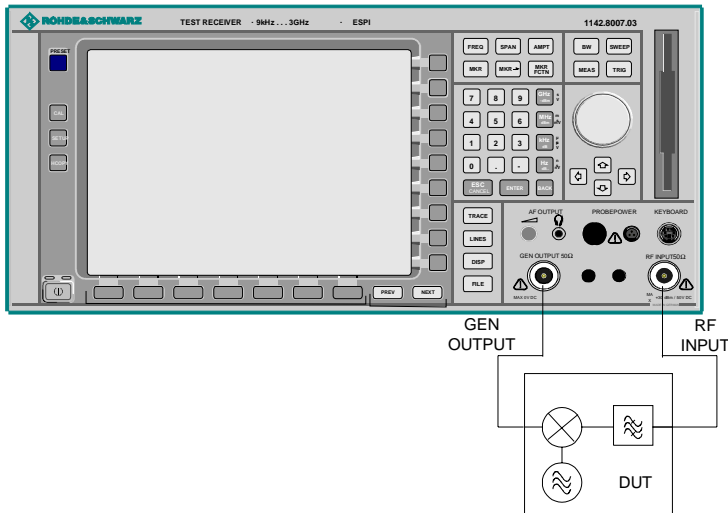

Fig.: 4-31 Test setup for frequency converting measurements

### NETWORK menu



The *FREQUENCY OFFSET* softkey activates the input of the frequency offset between the output signal of the tracking generator and the input frequency of the ESPI. Possible offsets are in a range of  $\pm 150$  MHz in 0.1 Hz steps.

The default setting is 0 Hz. Offsets  $\neq 0$  Hz are marked with the enhancement label **FRQ**.

If a positive frequency offset is entered, the tracking generator generates an output signal above the receive frequency of the ESPI. In case of a negative frequency offset it generates a signal below the receive frequency of the ESPI. The output frequency of the tracking generator is calculated as follows:

$$\text{Tracking generator frequency} = \text{receive frequency} + \text{frequency offset.}$$

IEC/IEEE-bus command: `SOUR:FREQ:OFFS 50MHz`

## External Modulation of the Tracking Generator

NETWORK menu:



The *MODULATION* softkey opens a submenu for selecting different modulation modes.

The time characteristics of the tracking generator output signal can be influenced by means of external signals (input voltage range -1 V to +1 V).

Two BNC connectors at the rear panel are available as signal inputs. Their function changes depending on the selected modulation:

*TG IN I / AM* and  
*TG IN Q / FM*

The modulation modes can be combined with each other and with the frequency offset function up to a certain degree. The following table shows which modulation modes are possible at the same time and which ones can be combined with the frequency offset function.

Table 4-5 Simultaneous modes of modulation (tracking generator)

Modulation	Frequency offset	EXT AM	EXT FM	EXT I/Q
Frequency offset		•	•	•
EXT AM	•		•	
EXT FM	•	•		
EXT I/Q	•			

• = can be combined

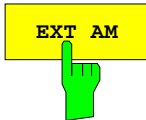

The *EXT AM* softkey activates an AM modulation of the tracking generator output signal.

The modulation signal is applied to the *TG IN I / AM* connector. An input voltage of 1 V corresponds to 100% amplitude modulation.

Switching on an external AM disables the following function:

- active I/Q modulation.

IEC/IEEE-bus command: `SOUR:AM:STAT ON`



The *EXT FM* softkey activates the FM modulation of the tracking generator output signal.

The modulation frequency range is 1 kHz to 100 kHz, the deviation can be set in 1-decade steps in the range of 100 Hz to 10 MHz at an input voltage of 1 V. The phase deviation  $\eta$  should not exceed the value 100.

$$\text{Phase deviation } \eta = \text{deviation} / \text{modulation frequency}$$

The modulation signal is applied to the *TG IN Q / FM* connector.

Switching on an external FM disables the following function:

- active I/Q modulation.

IEC/IEEE-bus command: `SOUR:FM:STAT ON`  
`SOUR:FM:DEV 10MHz`

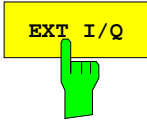

The *EXT I/Q* softkey activates the external I/Q modulation of the tracking generator.

The signals for modulation are applied to the two input connectors *TG IN I* and *TG IN Q* at the rear panel of the unit. The input voltage range is  $\pm 1$  V into 50  $\Omega$ .

Switching on an external I/Q modulation disables the following functions:

- active external AM
- active external FM

Functional description of the quadrature modulator:

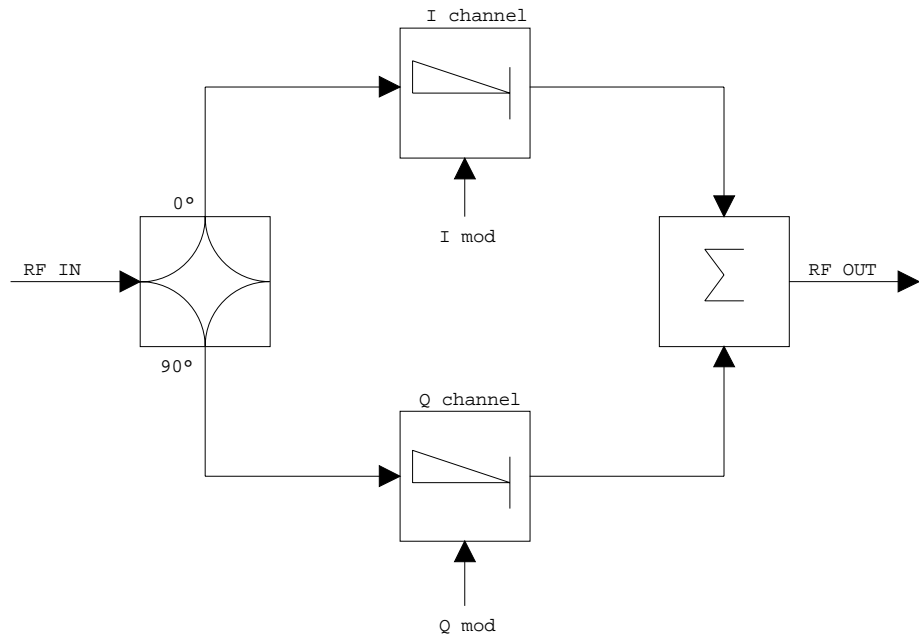
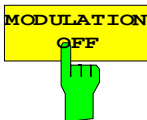

Fig.: 4-32 I/Q modulation

I/Q modulation is performed by means of the built-in quadrature modulator. The RF signal is divided into two orthogonal I and Q components (inphase and quadrature phase). Amplitude and phase are controlled in each path by the I and Q modulation signal. By adding the two components an RF output signal is generated that can be controlled in amplitude and phase.

IEC/IEEE-bus command: SOUR:DM:STAT ON



The *MODULATION OFF* softkey switches off the modulation of the tracking generator.

IEC/IEEE-bus command: SOUR:AM:STAT OFF  
 SOUR:FM:STAT OFF  
 SOUR:DM:STAT OFF

## Option External Generator Control - FSP-B10

The external generator control option permits to operate a number of commercially available generators as tracking generator on the ESPI. Thus, scalar network analysis with the ESPI is also possible outside the frequency range of the internal tracking generator when the appropriate generators are used.

The ESPI also permits to set a frequency offset for frequency-converting measurements when external generators are used. For harmonics measurements or frequency-converting measurements, it is also possible to enter a factor, by which the generator frequency is increased or reduced compared with the receive frequency of the ESPI. Only make sure that the resulting generator frequencies do not exceed the allowed setting range of the generator.

The settable level range also depends on the generator used.

The generator is controlled via the – optional – second IECBUS interface of the ESPI (= IEC2, supplied with the option) and, with some Rohde & Schwarz generators, additionally via the TTL synchronization interface included in the AUX interface of the ESPI.

**Note:** *The use of the TTL interface enables considerably higher measurement rates as pure IECBUS control, because the frequency stepping of the ESPI is directly coupled with the frequency stepping of the generator.*

Therefore, the frequency sweep differs according to the capabilities of the generator used:

- In the case of generators without TTL interface, the generator frequency is first set for each frequency point via IECBUS, then the setting procedure has to be completed before recording of measured values is possible.
- In the case of generators with TTL interface, a list of the frequencies to be set is entered into the generator before the beginning of the first sweep. Then the sweep is started and the next frequency point selected by means of the TTL handshake line TRIGGER. The recording of measured values is only enabled when the generator signals the end of the setting procedure via the BLANK signal. This method is considerably faster than pure IECBUS control.

With the "SELECT GENERATOR" softkey, a list of the supported generators with the frequency and level range as well as the capabilities used is included.

The external generator can be used in all operating modes. Recording of test setup calibration values (*SOURCE CAL*) and normalization with the correction values (*NORMALIZE*) are only possible in the *NETWORK* mode.

**Note:** *In order to enhance measurement accuracy a common reference frequency should be used for both the ESPI and the generator. If no independent 10 MHz reference frequency is available, it is recommended to connect the reference output of the generator with the reference input of the ESPI and to enable usage of the external Reference on the ESPI via SETUP – REFERENCE EXT.*

Like the internal tracking generator, the external generator is activated by means of the *NETWORK* hotkey in the hotkey bar at the screen bottom:

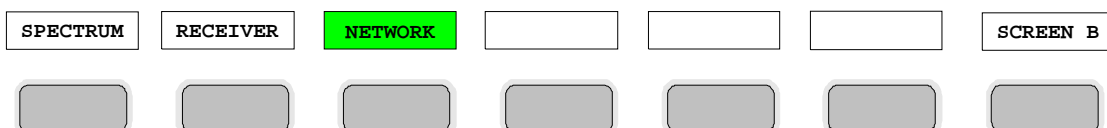

## External Generator Settings

The *NETWORK* hotkey opens the menu for setting the functions of the external generator.

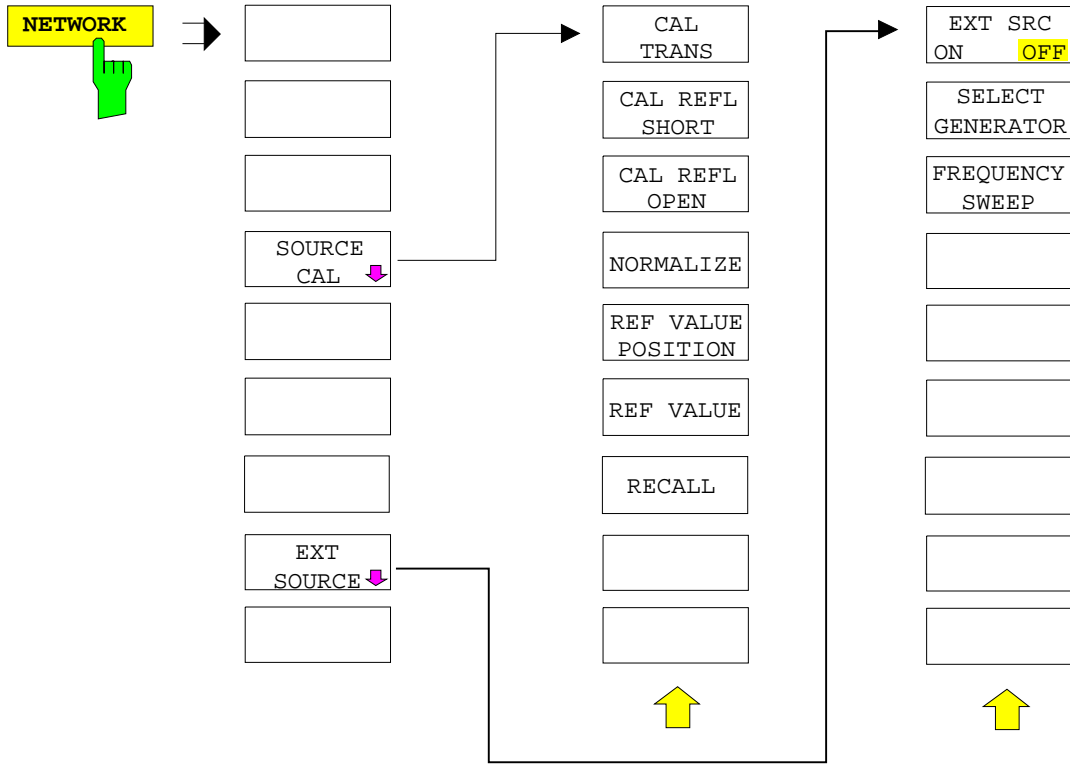

**Note:** Other softkeys are available in the displayed menus for controlling the internal tracking generator when option Tracking Generator FSP-B9 is fitted. For detailed information see section "Option Tracking Generator FSP-B9".

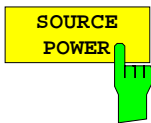

The *SOURCE POWER* softkey activates the input of the generator output level. The value range depends on the selected generator (See table of chapter "Configuration of the External Generator").

IEC/IEEE-bus command:      SOUR:EXT:POW -20dBm



## Transmission Measurement

The transmission characteristic of a two-port network is measured. The external generator serves as a signal source. It is connected to the input connector of the DUT. The input of the analyser is fed from the output of the DUT.

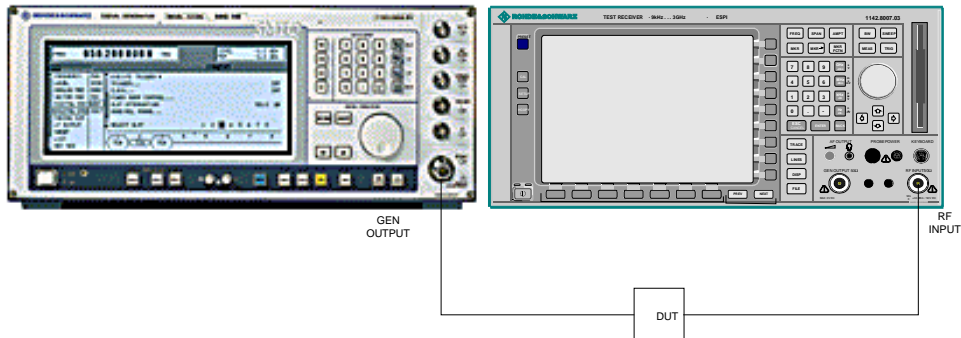
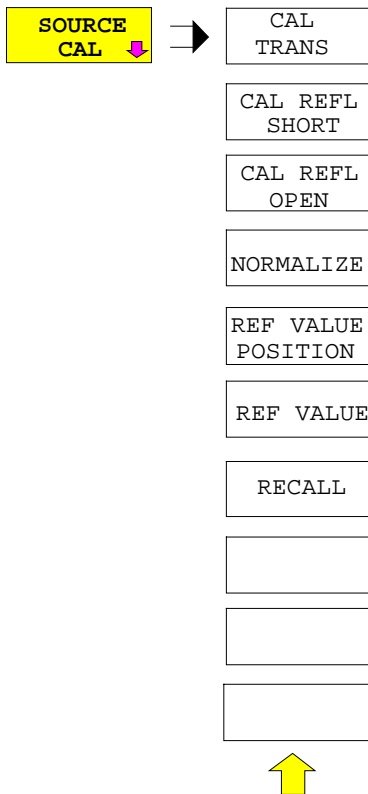

Fig. 4-33 Test setup for transmission measurement

A calibration can be carried out to compensate for the effects of the test setup (eg frequency response of connecting cables).

## Calibration of Transmission Measurement

NETWORK menu:



The *SOURCE CAL* softkey opens a submenu comprising the calibration functions for the transmission and reflection measurement.

The calibration of the reflection measurement (*CAL REFL...*) and its functioning are described in separate sections.

To carry out a calibration for transmission measurements the whole test setup is through-connected (THRU).

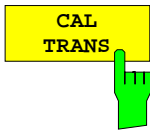

The *CAL TRANS* softkey triggers the calibration of the transmission measurement.

It starts a sweep that records a reference trace. This trace is then used to obtain the differences to the normalized values.

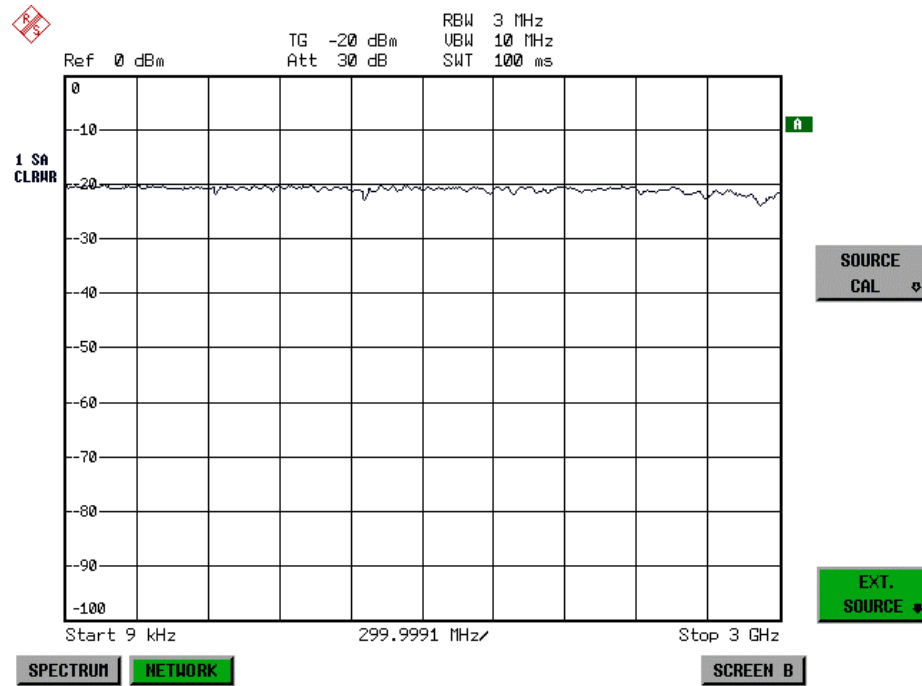
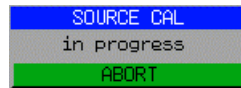
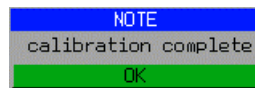

Fig. 4-34 Calibration curve for transmission measurement

During the calibration the following message is displayed:



After the calibration sweep the following message is displayed:



This message is cleared after approx. 3 seconds.

IEC-bus command `CORR:METH TRAN`

**Normalization:**

NETWORK -SOURCE CAL menu:

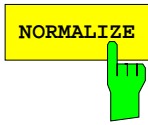

The *NORMALIZE* softkey switches normalization on or off. The softkey is only available if the memory contains a correction trace.

It is possible to shift the relative reference point within the grid using the *REF VALUE POSITION* softkey. Thus, the trace can be shifted from the top grid margin to the middle of the grid:

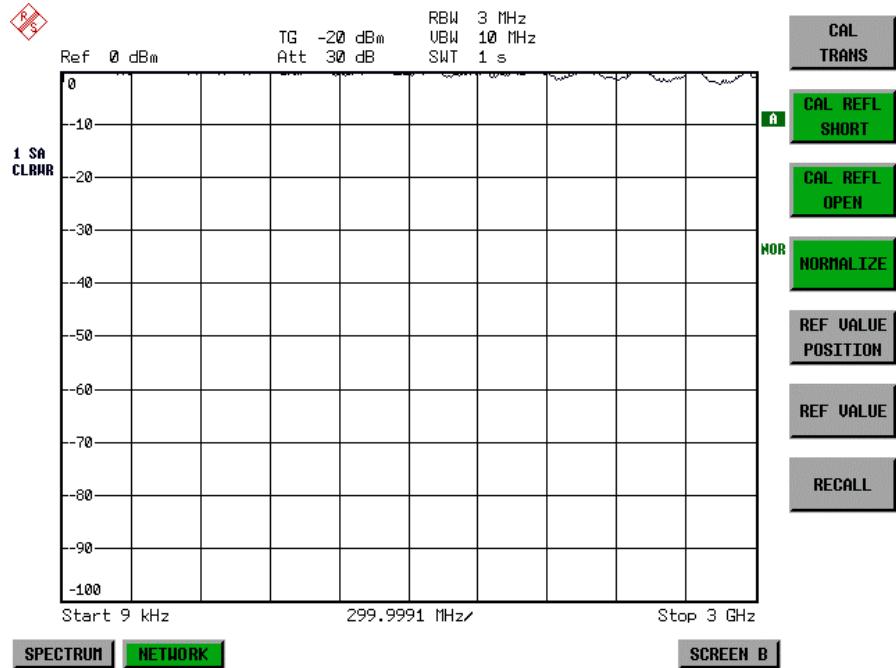
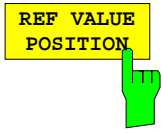

Fig. 4-35 Normalized display

In the *SPLIT SCREEN* setting, the normalization is switched on in the current window. Different normalizations can be active in the two windows.

Normalization is aborted when the *NETWORK* mode is quit.

IEC/IEEE-bus command: CORR ON



The *REF VALUE POSITION* softkey (reference position) marks a reference position in the active window on which the normalization (difference formation with a reference curve) is performed.

When pressed for the first time, the softkey switches on the reference line and activates the input of its position. The line can be shifted within the grid limits.

The reference line is switched off by pressing the softkey again.

The function of the reference line is explained in the section "Functioning of Calibration".

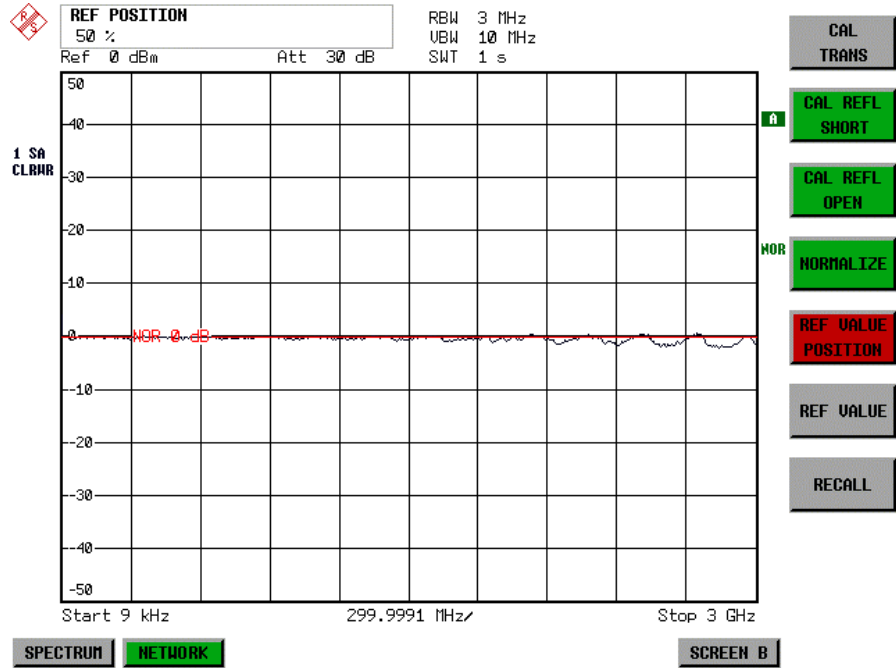
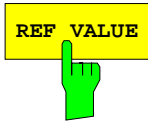

Fig. 4-36 Normalized measurement, shifted with *REF VALUE POSITION* 50 %

IEC-bus command      DISP:WIND:TRAC:Y:RPOS 10PCT



The *REF VALUE* softkey activates the input of a level difference which is assigned to the reference line.

In the default setting, the reference line corresponds to a level difference of 0 dB. If e.g. a 10-dB attenuator pad is inserted between DUT and input of ESPI between recording of the calibration data and normalization, the trace will be shifted down by 10 dB. By entering a *REF VALUE* of -10 dB the reference line for difference formation can also be shifted down by 10 dB so that it will again coincide with the trace (see Fig. 4-37).

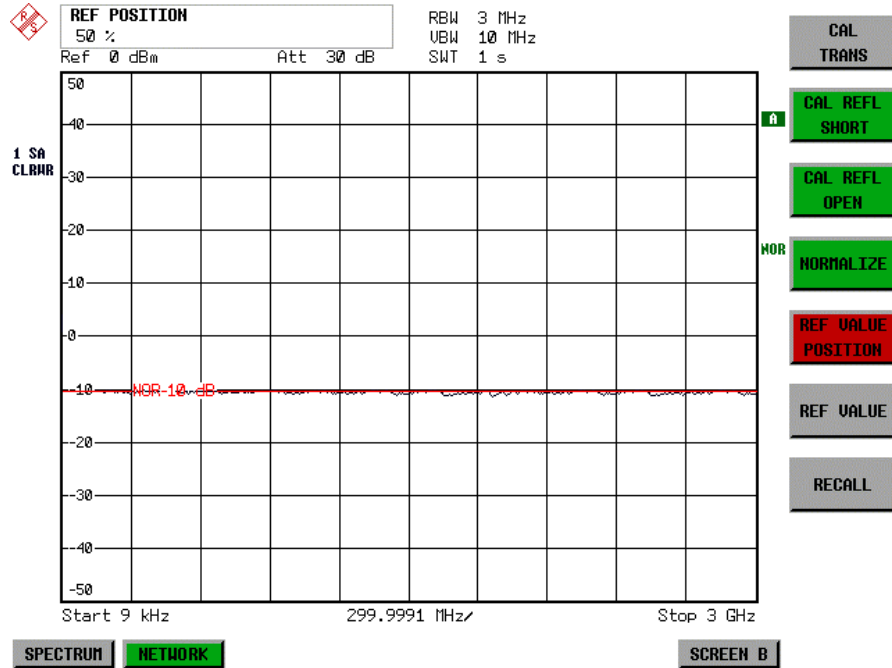

Fig. 4-37 Measurement with REF VALUE -10dB and REF VALUE POSITION 50%

After the reference line has been shifted by entering *REF VALUE* -10 dB, departures from the nominal value can be displayed with high resolution (e.g. 1 dB / Div.). The absolute measured values are still displayed, in the above example, 1 dB below nominal value (reference line) = 11 dB attenuation.

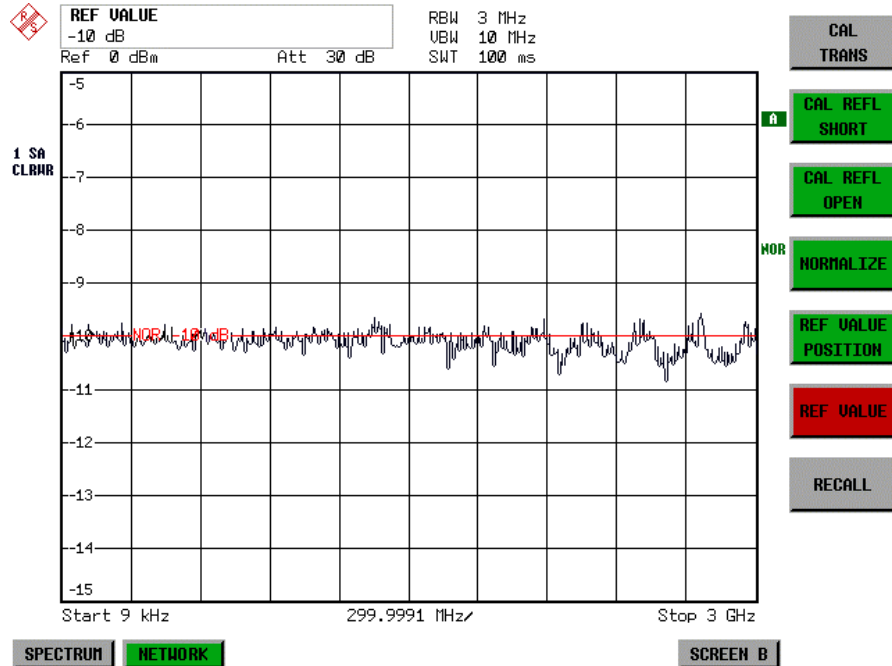
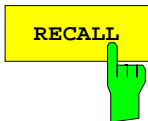

Fig. 4-38 Measurement of a 10-dB attenuator pad with 1dB/DIV

IEC-bus command `DISP:WIND:TRAC:Y:RVAL -10dB`



The *RECALL* softkey restores the instrument setting with which the calibration was carried out. This can be useful if the device setting was changed after calibration (eg center frequency setting, frequency deviation, reference level, etc).

The softkey is only available if:

- the *NETWORK* mode has been selected
- the memory contains a calibration data set.

IEC/IEEE-bus command `CORR:REC`

## Reflection Measurement

Scalar reflection measurements can be carried out by means of a reflection-coefficient bridge.

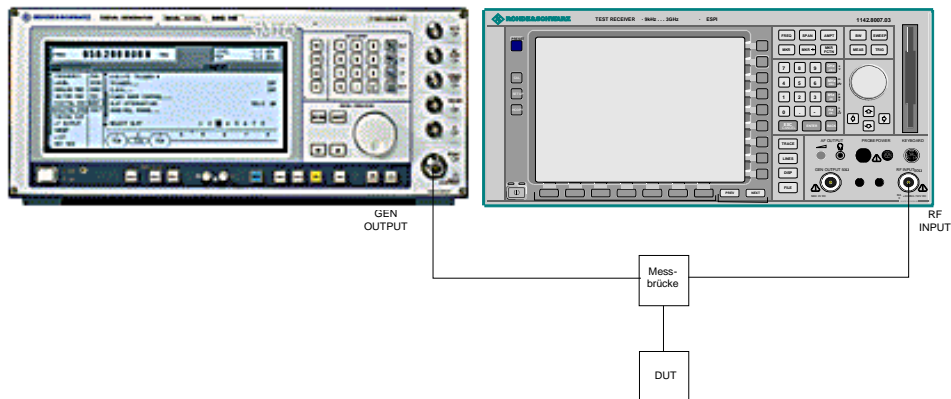

Fig. 4-39 Test setup for reflection measurement

## Calibration of Reflection Measurement

The calibration mechanism essentially corresponds to that of the transmission measurement.

NETWORK-SOURCE CAL submenu



The *CAL REFL OPEN* softkey starts the open-circuit calibration. During calibration the following message is displayed:



IEC-bus command      CORR:METH REFL  
                              CORR:COLL OPEN



The *CAL REFL SHORT* softkey starts the short-circuit calibration.

If both calibrations (open circuit, short circuit) are carried out, the calibration curve is formed by averaging the two measurements and stored in the memory. The order of measurements is optional.

After the calibration the following message is displayed:

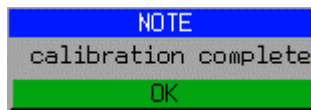

The display is cleared after approx. 3 seconds.

IEC-bus command      CORR:METH REFL  
                              CORR:COLL THR

## Calibration mechanism

Calibration means a calculation of the difference between the currently measured power and a reference curve, independent of the selected type of measurement (transmission/reflection). The hardware settings used for measuring the reference curve are included in the reference dataset.

Even with normalization switched on, the device settings can be changed in a wide area without stopping the normalization. This reduces the necessity to carry out a new normalization to a minimum.

For this purpose the reference dataset (trace with 501 measured values) is stored internally as a table of 501 points (frequency/level).

Differences in level settings between the reference curve and the current device settings are taken into account automatically. If the span is reduced, a linear interpolation of the intermediate values is applied. If the span increases, the values at the left or right border of the reference dataset are extrapolated to the current start or stop frequency, ie the reference dataset is extended by constant values.

An enhancement label is used to mark the different levels of measurement accuracy. This enhancement label is displayed at the right diagram border when normalization is switched on and a deviation from the reference setting occurs. Three accuracy levels are defined:

Table 4-5 Measurement accuracy levels

Accuracy	Enhancement label	Reason/Limitation
High	NOR	No difference between reference setting and measurement
Medium	APX (approximation)	Change of the following settings: <ul style="list-style-type: none"> <li>• coupling (RBW, VBW, SWT)</li> <li>• reference level, RF attenuation</li> <li>• start or stop frequency</li> <li>• output level of tracking generator</li> <li>• frequency offset of tracking generator</li> <li>• detector (max. peak, min. peak, sample, etc.)</li> </ul> Change of frequency: <ul style="list-style-type: none"> <li>• max. 501 points within the set sweep limits (corresponds to a doubling of the span)</li> </ul>
-	Aborted normalization	<ul style="list-style-type: none"> <li>• more than 500 extrapolated points within the current sweep limits (in case of span doubling)</li> </ul>

**Note:** At a reference level (REF LEVEL) of -10 dBm and at a tracking generator output level of the same value the ESPI operates without overrange reserve, ie the ESPI is in danger of being overloaded if a signal is applied whose amplitude is higher than the reference line. In this case, either the message "OVLD" for overload is displayed in the status line or the display range is exceeded (clipping of the trace at the upper diagram border = Overrange).

Overloading can be avoided as follows:

- Reducing the output level of the tracking generator (SOURCE POWER, NETWORK menu)
- Increasing the reference level (REF LEVEL, AMPT menu)



## Frequency-converting Measurements

For frequency-converting measurements (e.g. on converters) the external generator is able to set a constant frequency offset between the output frequency of the generator and the receive frequency of the ESPI and, in addition, the generator frequency as a multiple of the ESPI.

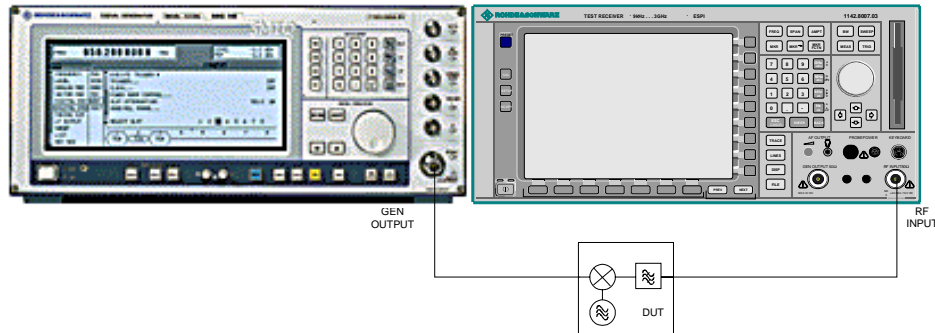
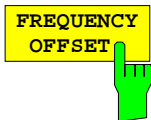

Fig. 4-40 Test setup for frequency-converting measurements

### NETWORK Menü



The *FREQUENCY OFFSET* softkey activates the input of the frequency offset between the output signal of the generator and the input frequency of the ESPI. The value range depends on the selected generator. The default setting is 0 Hz. Offsets  $< 0$  Hz are marked with the enhancement label **FRQ**.

If a positive frequency offset is entered, the tracking generator generates an output signal above the receive frequency of the ESPI. In case of a negative frequency offset it generates a signal below the receive frequency of the ESPI. The output frequency of the generator is calculated as follows:

$$\text{Generator frequency} = \text{receive frequency} + \text{frequency offset}$$

IEC/IEEE-bus command:        `SOUR:EXT:FREQ:OFFS 1GHZ`

## Configuration of an External Generator

NETWORK menu:

SELECT GENERATOR								
SRC	TYPE	IFC	GPIB ADDR	MODE	F MIN	F MAX	P MIN	P MAX
1	SME03	TTL	28	REMOTE	5kHz	3GHz	-144dBm	16dBm
2	SMIQ03	GPIB	28	LOCAL	300kHz	3.3GHz	-140dBm	13dBm

FREQUENCY SWEEP						
SRC	STATE	POWER[dBm]	NUM	DEN	OFFSET	RESULT
1	✓	-30dBm	1	1	0Hz	0Hz..3GHz *
2		-30dBm	1	1	0Hz	0Hz..3.2GHz



The *EXT SOURCE* softkey opens a submenu for configuration of the external generator. The ESPI is able to manage two generators, one of which can be active at the time.

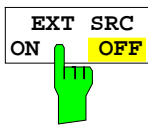

The *EXT SRC ON / OFF* softkey switches the external generator on or off. It can only be switched on successfully if the generator has been selected by means of *SELECT GENERATOR* and configured correctly by means of *FREQUENCY SWEEP*. If one of these conditions is not fulfilled, an error message will be output.

**Notes:**

When switching on the external generator, the ESPI switches off the internal tracking generator and starts programming the generator settings via the IECBUS.

At the same time, the maximum stop frequency is limited to the maximum generator frequency. This upper limit is automatically reduced by the set frequency offset of the generator and a set multiplication factor.

With the external generator switched on, the FFT filters (FILTER TYPE FFT in the menu BW) are not available.

If there is an error on the IECBUS during programming of the external generator, the generator is automatically switched off and the following error message output:



IEC-bus command SOUR:EXT ON

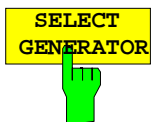

The *SELECT GENERATOR* softkey opens a table for selection of the generator and definition of IECBUS address and control interface. The table permits configuration of two generators so that switching between two different configurations is easily possible.

SELECT GENERATOR								
SRC	TYPE	IFC	GPIB ADDR	MODE	F MIN	F MAX	P MIN	P MAX
1	SME03	TTL	28	REMOTE	5kHz	3GHz	-144dBm	16dBm
2	SMIQ03	GPIB	28	LOCAL	300kHz	3.3GHz	-140dBm	13dBm

The individual fields contain the following settings:

- SRC Index of generator selected
- TYPE The field opens the list with the available generators:

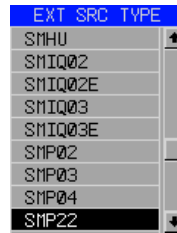

After completion of the selection, the remaining fields of the table are filled with the generator characteristics.

A list of generator types supported by the ESPI is to be found at the end of section "Softkey *SELECT GENERATOR*".

- IFC This field selects the interface type of external generator 1or 2. The following types are available:

GPIB IECBUS only, suitable for all generators of other manufacturers and some Rohde & Schwarz instruments  
or

TTL IECBUS and TTL interface for synchronization, for most of the Rohde & Schwarz generators, see table above.

The two operating modes differ in the speed of the control: Whereas, with pure IECBUS operation, each frequency to be set must be individually transferred to the generator, additional use of the TTL interface permits to program a total frequency list at once and subsequently perform the frequency stepping via TTL handshake, which is a big advantage in terms of speed.

**Note:**

*Generators equipped with the TTL interface can also be operated with IECBUS (= GPIB) only.*

*Only one of the two generators can be operated with TTL interface at a time. The other generator must be configured for IECBUS (GPIB).*

- GPIB ADDR IECBUS address of the respective generator. Addresses from 0 to 30 are possible.

- MODE Operating mode of generator. The generator activated using the FREQUENCY SWEEP softkey is automatically set to remote mode (REMOTE), the other to manual mode (LOCAL).

- F MIN Frequency range of generator. Select the start and stop frequency of the ESPI in a way that the specified range is not exceeded.

If the start frequency lies below F MIN, the generator is only switched on when F MIN is reached.

If the stop frequency lies above F MAX, it is limited to F MAX when the generator is switched on using the EXT SRC ON/OFF softkey.

- P MIN Level range of generator. This field defines the allowed input range for
- P MAX the POWER column in the FREQUENCY SWEEP table.

IEC-bus commands SYST:COMM:RDEV:GEN2:TYPE 'SME02'  
SYST:COMM:RDEV:GEN:LINK TTL  
SYST:COMM:GPIB:RDEV:GEN1:ADDR 28

## List of Generator Types Supported by the ESPI

Generator	Interface Type	Generator Min Freq	Generator Max Freq	Generator Min Power dBm	Generator Max Power dBm
SME02	TTL	5 kHz	1.5 GHz	-144	+16
SME03	TTL	5 kHz	3.0 GHz	-144	+16
SME06	TTL	5 kHz	6.0 GHz	-144	+16
SMG	GPIB	100 kHz	1.0 GHz	-137	+13
SMGL	GPIB	9 kHz	1.0 GHz	-118	+30
SMGU	GPIB	100 kHz	2.16 GHz	-140	+13
SMH	GPIB	100 kHz	2.0 GHz	-140	+13
SMHU	GPIB	100 kHz	4.32 GHz	-140	+13
SMIQ02B	TTL	300 kHz	2.2 GHz	-144	+13
SMIQ02E	GPIB	300 kHz	2.2 GHz	-144	+13
SMIQ03B	TTL	300 kHz	3.3 GHz	-144	+13
SMIQ03E	GPIB	300 kHz	3.3 GHz	-144	+13
SMIQ04B	TTL	300 kHz	4.4 GHz	-144	+10
SMIQ06B	TTL	300 kHz	6.4 GHz	-144	+10
SML01	GPIB	9 kHz	1.1 GHz	-140	+13
SML02	GPIB	9 kHz	2.2 GHz	-140	+13
SML03	GPIB	9 kHz	3.3 GHz	-140	+13
SMR20	GPIB	1 GHz	20 GHz	-130 <sup>2)</sup>	+11 <sup>2)</sup>
SMR20B11 <sup>1)</sup>	GPIB	10 MHz	20 GHz	-130 <sup>2)</sup>	+13 <sup>2)</sup>
SMR27	GPIB	1 GHz	27 GHz	-130 <sup>2)</sup>	+11 <sup>2)</sup>
SMR27B11 <sup>1)</sup>	GPIB	10 MHz	27 GHz	-130 <sup>2)</sup>	+12 <sup>2)</sup>
SMR30	GPIB	1 GHz	30 GHz	-130 <sup>2)</sup>	+11 <sup>2)</sup>
SMR30B11 <sup>1)</sup>	GPIB	10 MHz	30 GHz	-130 <sup>2)</sup>	+12 <sup>2)</sup>
SMR40	GPIB	1 GHz	40 GHz	-130 <sup>2)</sup>	+9 <sup>2)</sup>
SMR40B11 <sup>1)</sup>	GPIB	10 MHz	40 GHz	-130 <sup>2)</sup>	+12 <sup>2)</sup>
SMP02	TTL	10 MHz	20 GHz	-130 <sup>3)</sup>	+17 <sup>3)</sup>
SMP03	TTL	10 MHz	27 GHz	-130 <sup>3)</sup>	+13 <sup>3)</sup>
SMP04	TTL	10 MHz	40 GHz	-130 <sup>3)</sup>	+12 <sup>3)</sup>
SMP22	TTL	10 MHz	20 GHz	-130 <sup>3)</sup>	+20 <sup>3)</sup>
SMT02	GPIB	5.0 kHz	1.5 GHz	-144	+13
SMT03	GPIB	5.0 kHz	3.0 GHz	-144	+13
SMT06	GPIB	5.0 kHz	6.0 GHz	-144	+13
SMX	GPIB	100 kHz	1.0 GHz	-137	+13
SMY01	GPIB	9 kHz	1.04 GHz	-140	+13
SMY02	GPIB	9 kHz	2.08 GHz	-140	+13
HP8340A	GPIB	10 MHz	26.5 GHz	-110	10
HP ESG-A Series 1000A, 2000A, 3000A, 4000A	GPIB	250 kHz	4 GHz	-136	20
HP ESG-D SERIES E4432B	GPIB	250 kHz	3 GHz	-136	+10

<sup>1)</sup> Requires the option SMR-B11 to be fitted.

<sup>2)</sup> Maximum/minimum power depends on presence of Option SMR-B15/-B17 and set frequency range. For more details see SMR data sheet.

<sup>3)</sup> Maximum/minimum power depends on presence of Option SMP-B15/-B17 and set frequency range. For more details see SMP data sheet.

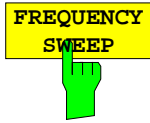

The *FREQUENCY SWEEP* softkey opens a table for setting the generator level as well as the multiplier and the offset used to derive the generator frequency from the analyzer frequency.

This table also permits configuration of two generators so that switching between two different configurations is easily possible.

FREQUENCY SWEEP						
SOURCE FREQ = REC FREQ * NUM/DEN + OFFSET						
SRC	STATE	POWER[dBm]	NUM	DEN	OFFSET	RESULT
1	✓	-30dBm	1	1	0Hz	0Hz..3GHz *
2		-30dBm	1	1	0Hz	0Hz..3.2GHz

- SRC Index of selected generator
- STATE Selects the active generator. Only one generator can be active at a time. The operating mode of the active generator is set to remote control in the *SELECT GENERATOR* table.
- POWER Permits to enter the generator level within the limits P MIN to P MAX of the *SELECT GENERATOR* table.
- NUM Numerator,
- DEN Denominator,
- OFFSET Offset, used to derive the generator frequency from the current frequency of the ESPI according to the following formula:

$$F_{Generator} = F_{Analyzer} * \frac{Numerator}{Denominator} + F_{Offset}$$

Note that the frequencies resulting from start and stop frequency of the ESPI do not exceed the allowed generator range:

- If the start frequency lies below F MIN, the generator is only switched on when F MIN is reached.
- If the stop frequency lies above F MAX, the generator is switched off. When the generator is subsequently switched on using the *EXT SRC ON/OFF* softkey, the stop frequency is limited to F MAX.
- If the stop frequency lies below F MIN, the generator is switched off and the following error message output:

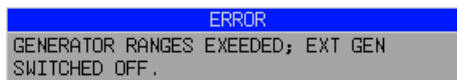

- In the time domain (Span = 0 Hz) the generator frequency is derived from the set receive frequency of the ESPI using the calculation formula.

For the sake of clarity, the formula is also displayed in the table.

RESULT The frequency range of the generator resulting from the calculation formula. An asterisk (\*) after the upper limit indicates that the stop frequency of the ESPI must be adapted when the generator is switched on in order not to exceed its maximum frequency. In the following illustration, this is true for the upper generator at a stop frequency of 3.2 GHz of the ESPI, whereas the lower generator does not yet require an adaptation:

SOURCE FREQ = REC FREQ * NUM/DEN + OFFSET				
	NUM	DEN	OFFSET	RESULT
	1	1	0Hz	0Hz..3GHz *
	1	1	0Hz	0Hz..3.2GHz

IEC-bus commands    SOUR:EXT:POW -30dBm  
                          SOUR:EXT:FREQ:NUM 4  
                          SOUR:EXT:FREQ:DEN 3  
                          SOUR:EXT:FREQ:OFFS 100MHZ

## Option LAN Interface – FSP-B16

Using the option FSP-B16 LAN Interface, the instrument can be connected to an Ethernet LAN (Local Area Network). Thus it is possible to transfer data via the network and use network printers. In addition, the instrument can be remote controlled via the network. Außerdem kann das Gerät über Netzwerk fernbedient werden. The network card allows both for a 10-MHz Ethernet IEEE 802.3 and a 100-MHz Ethernet IEEE 802.3u. The selection between 10 Mbit/s and 100Mbit/s can take place either automatically or via manual setting.

### Connecting the Instrument to the Network

**Caution:**

*Before connecting the instrument to the network it is recommended to contact the network administrator, in particular larger LAN installations are affected. Faults in the connection may have a negative effect on the entire network.*

The instrument is connected to a network hub of the desired LAN segment via a commercially-available RJ45 cable (not supplied with the instrument) at the instrument rear panel. Since RJ45 provides no bus but a star network topology, no other precautions need to be taken for the connection.

The connection procedure does not produce any disturbances in the network traffic. Disconnection from the network is easily possible provided that there is no more data traffic from and to the instrument.

### Installing the Software

The data transfer in the network takes place in data blocks, the so-called packets. In addition to the useful data, further information on the operation, ie the so-called protocol data (transmitter, receiver, type of data, sequence), is transferred in the packets. For processing the protocol information, suitable drivers must be installed. For the network services (file transfer, directory services, printing in the network) a network operating system needs to be installed.

### Installation and Configuration of the Driver for the Network Card

- Notes:**
- *The WINDOWS NT files required for the installation of network drivers, protocols or services are included in the directory "C:\V386".*
  - *For the installation, a PC keyboard with trackball (or an additional mouse instead) is required.*

- 
- Press the *SETUP* key.  
The *SETUP* menu opens.
  - Press the *GENERAL SETUP* key.  
The *GENERAL SETUP* menu opens.
  - Press the *CONFIGURE NETWORK* softkey.

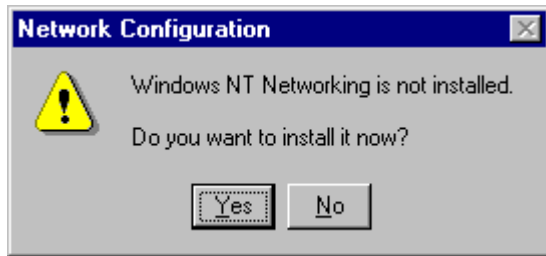

- Answer the prompt "Do you want to install it now?" with "Yes".

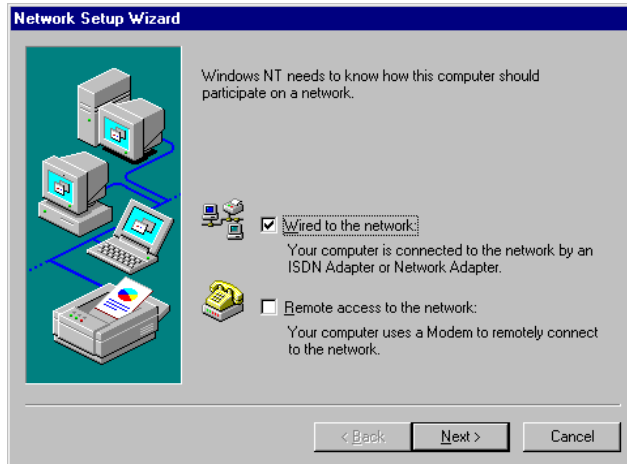

- Leave the default setting "Wired to the network" unchanged and confirm by means of "NEXT".

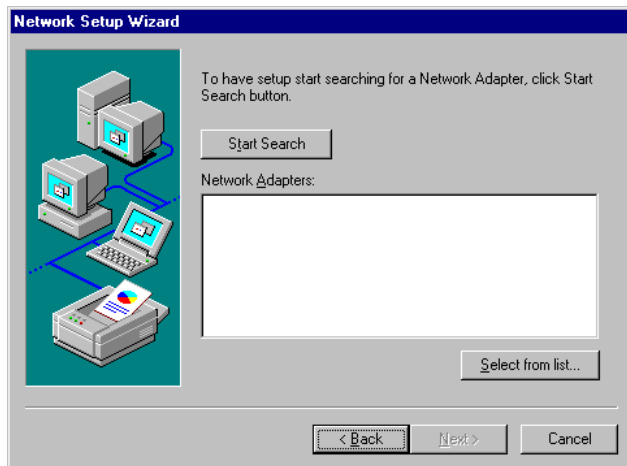

- To select the appropriate network card click on "Select from list".



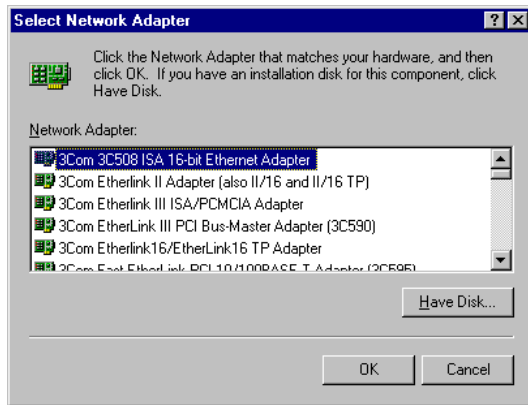

- Click on "Have Disk".

A prompt to enter a pathname will appear.

- Enter the following pathname:  
'C:\WINNT\R&S\_drivers\Etherexp' and click on 'OK'.

**Note:** If this path does not exist, enter "A:" as a pathname. Insert the driver disk and click on "OK".

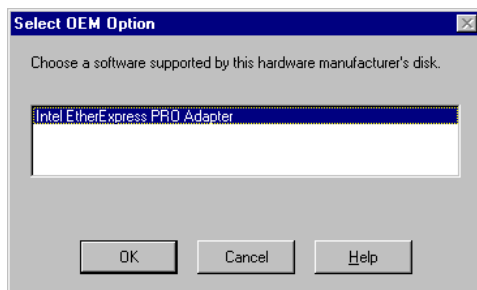
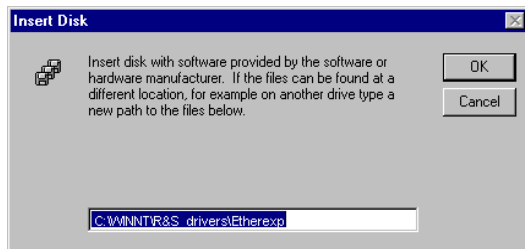

- Confirm 'Intel EtherExpress PRO Adapter' with 'OK'.

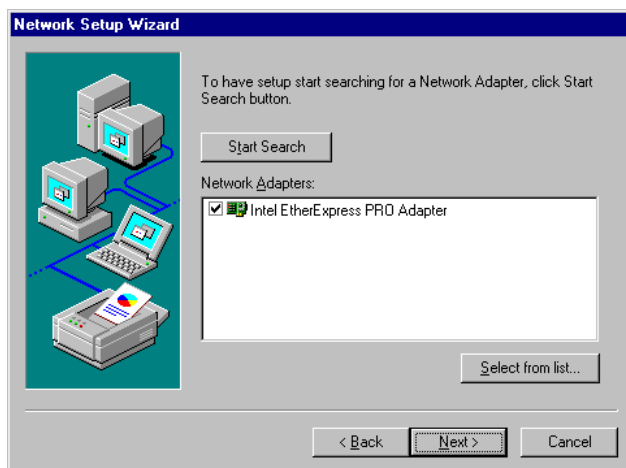

- Close the dialog by means of 'NEXT' after selecting 'Intel EtherExpress PRO Adapter' once again

## Selection of the Network Protocols

**Note:** The network administrator knows the protocols to be used. For the RSIB interface, the TCP/IP protocol must be installed in any case.

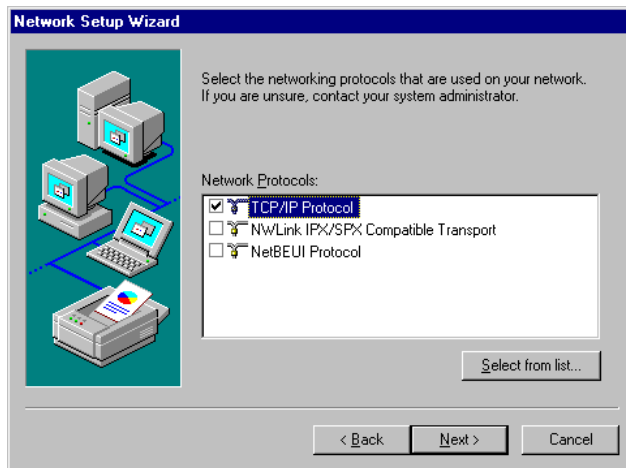

- Select the desired protocols and confirm using "NEXT".

## Selection of the Network Services

To be able to utilize the resources in the network, it is necessary to install the respective services.

**Note:** The network administrator knows the services to be used.

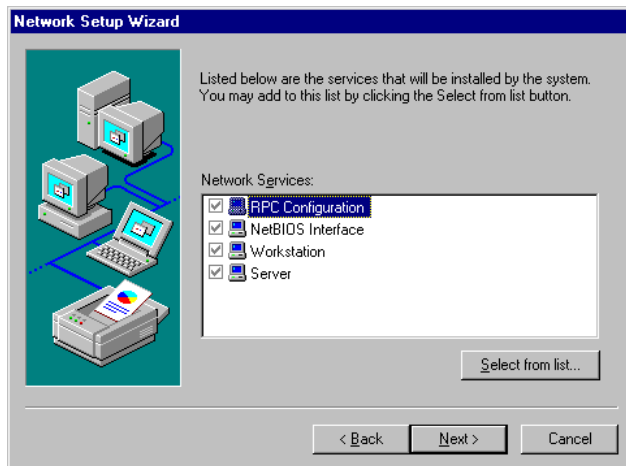

- During the first installation, the selected services cannot be changed.  
Further services can be added after completion of the installation.

## Completion of the Installation

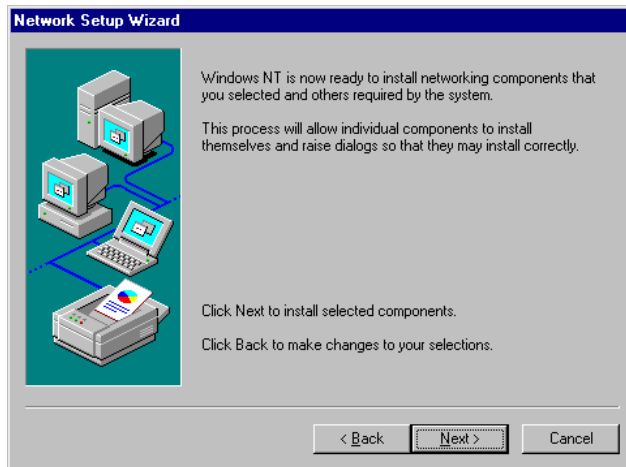

- Start the installation by clicking on "NEXT" .

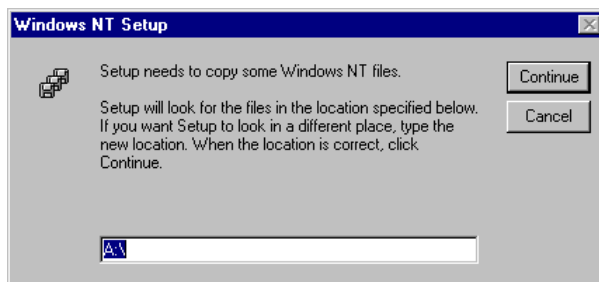

- Enter drive "C:\I386" and click on "Continue".

After a couple of files have been copied, there is a message indicating that the driver for the network card has been installed.

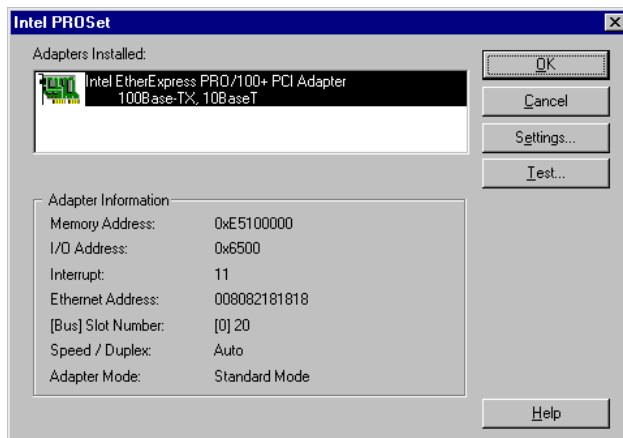

If required, the network speed and the duplex mode can be set manually using the "Settings" button.

- Click on "OK".

The settings are checked and processed. Missing information on the installed network protocols (e.g. the TCP/IP address) is queried.

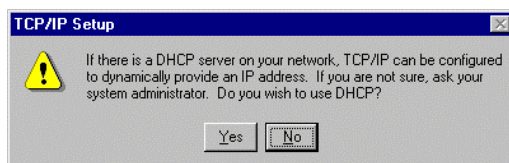

- Confirm the query with "Yes" if the network comprises a DHCP-server. The IP address is automatically assigned.

Or

- Answer the query with "No" if there is no DHCP-server in the network. The IP address assigned to the instrument must be entered manually (see below).

The network administrator knows whether a DHCP server is used.

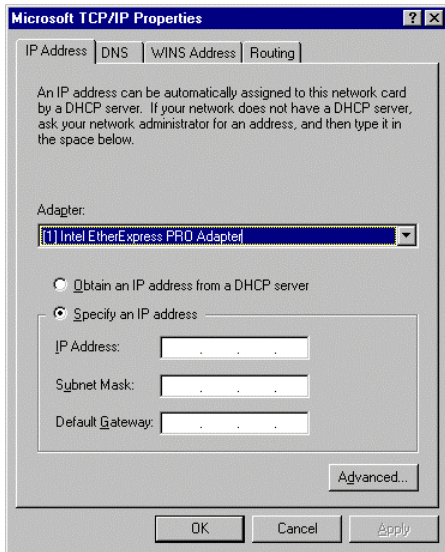

Manual entry of an IP address (not if a DHCP server is used):

- Do not change selection "Adapter".
- Click on "Specify an IP address" .
- Enter the IP address and subnet mask assigned to the instrument. The IP address and subnet-mask can be obtained from your network administrator.

**Note:**

*For factory-fitted network cards the default settings are*

**IP address**            **10.0.0.10**  
**subnet mask**        **255,255,255,0 .**

- Confirm with "OK".

The Network Bindings dialog opens next.

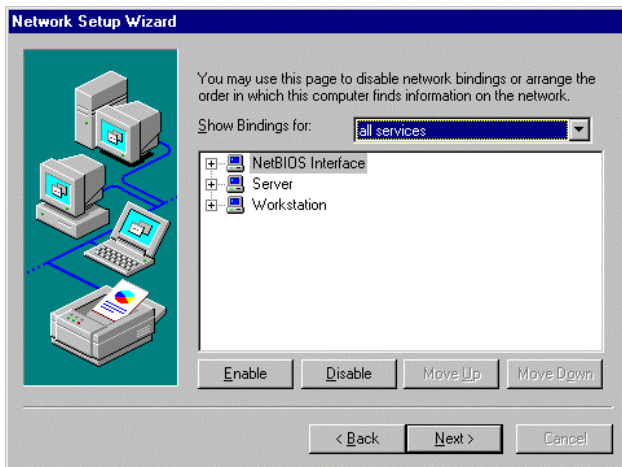

- Do **not** change the settings and click on "Next" to leave the dialog.

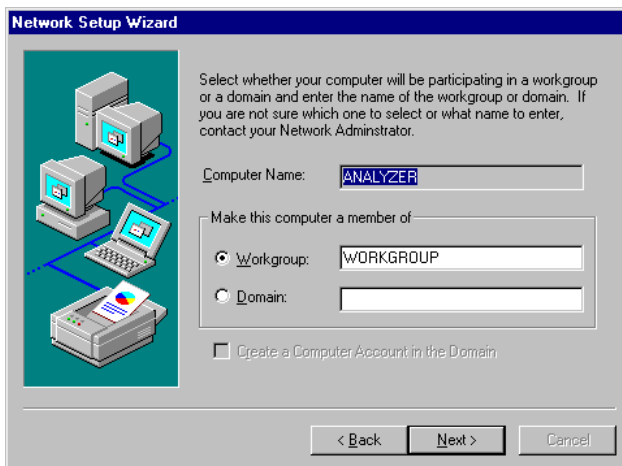

- The preselected computer and workgroup names "ANALYZER" and "WORKGROUP" can be confirmed using "NEXT".

**Note:**

*In Windows networks, the computer name must be unique.*

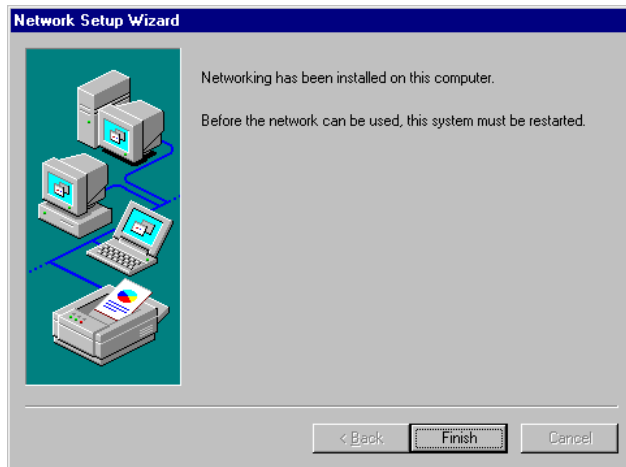

- Terminate the installation by clicking on "Finish".

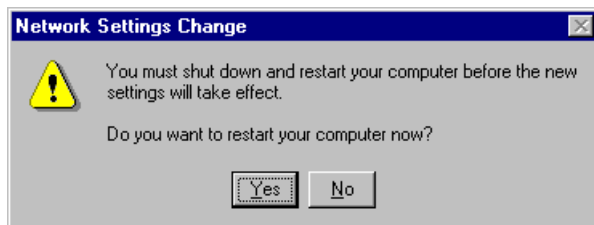

- Answer the prompt "You must shutdown..." with "No", since the "Service Pack 5" of Windows NT must be reinstalled after the installation of the driver software. (see chapter 1, section "Installing the Windows NT Software")

**Note:**

*If the service pack is not installed, the following error message will be displayed: "At least one service or driver failed during system startup..." **In this case, the network installation is not fully operational.** To prevent faults, it is therefore indispensable to reinstall the service pack (see chapter 1, section "Installing the Windows NT Software").*

## Examples of Configurations

Network	Protocols	Services	Notes
NOVELL Netware	NWLink IPX/SPX Compatible Transport	Client Service for NetWare	In folder "Protocols - Properties", the frame type used in the network is to be set.
IP Networks (FTP, TELNET, WWW, GOPHER, etc.)	TCP/IP Protocol	Simple TCP/IP Services	In folder "Protocols - Properties", an IP address that is unique in the network is to be set.
MICROSOFT Network	NetBEUI Protocol or TCP/IP Protocol	Workstation Server	In folder "Identification - Computer Name", a name that is unique in the network is to be entered.

## Subsequent Changing of the Network Configuration (Computer Name etc.)

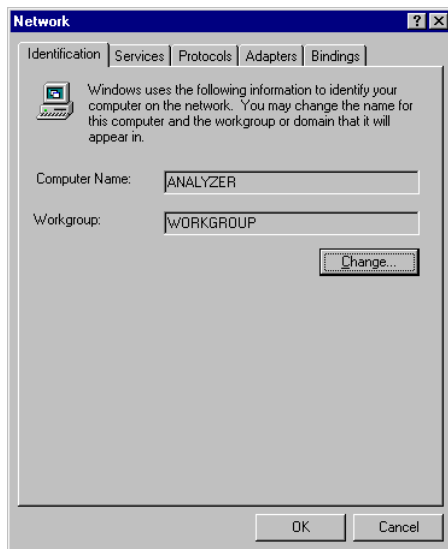

After completion of the installation, the computer name can be adapted as follows:

- Press the *SETUP* key.  
The *SETUP* menu opens.
- Press softkey *GENERAL SETUP*.  
The *GENERAL SETUP* menu opens.
- Press softkey *CONFIGURE NETWORK*.  
The configuration menu "Network" for the network settings opens.
- Select folder "Identification".  
Both entries can be changed in the submenu "Change".

The other settings can be changed after selecting the other folders. However, it is recommended to contact the network administrator before any changes.

## Uninstallation of the Network Card Driver – Installation of the MS Loopback Adapter

If the instrument is to be operated without a network connection for a limited or an unlimited period of time, the networkcard driver must be uninstalled or at least disabled. However, it is not possible to uninstall the driver without installing another network driver on the analyzer, since this would impair the performance of the instrument.

Therefore, the network card driver is replaced by the "MS Loopback Adapter" (supplied with the instrument). This pseudo network card driver simulates the existence of a network including network card and can, therefore, also be installed if the system does not contain a network card or if an existing network card is to be removed from the instrumen.

### **Note:**

*The "MS Loopback Adapter" must be installed prior to removing the network card from the instrument. Otherwise there will be driver conflicts when the instrument is started the next time..*

The following steps are required for the installation of the MS Loopback Adapter:

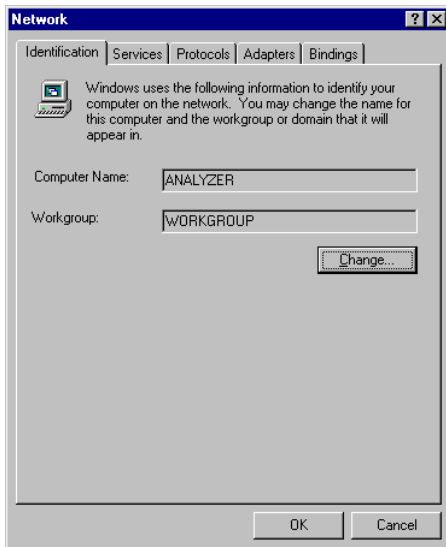

- Press the *SETUP* key.  
The *SETUP* menu opens.
- Press the *GENERAL SETUP* key.  
The *GENERAL SETUP* menu opens.
- Press the *CONFIGURE NETWORK* softkey.  
The menu for configuration of the network settings is opened.
- Select tab "Adapters".

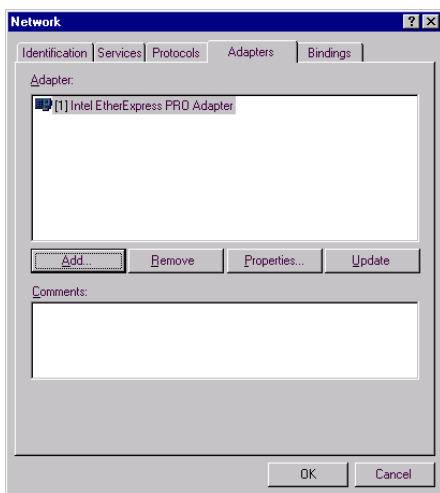

The active network driver is displayed.

- Click button *Add* .  
The list of available network drivers opens.

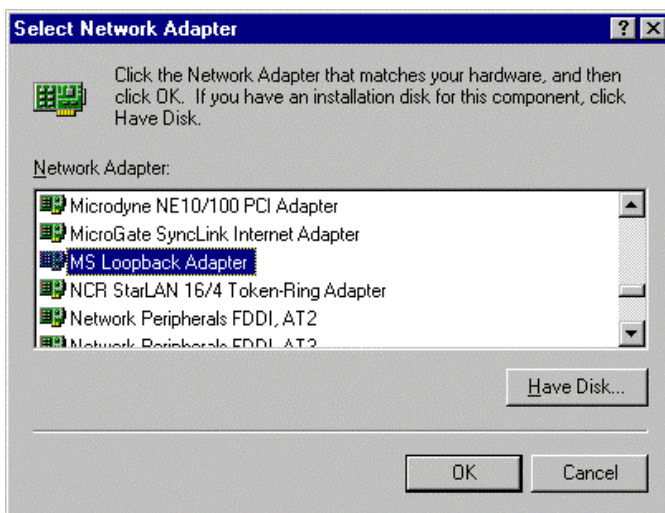

- Click "MS Loopback Adapter" and confirm with "OK".  
The OEM options selection appears.

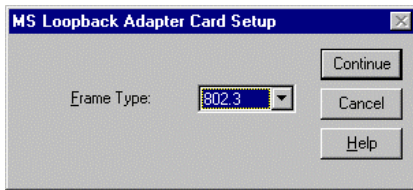

- Confirm frame type "802.3" with "OK".

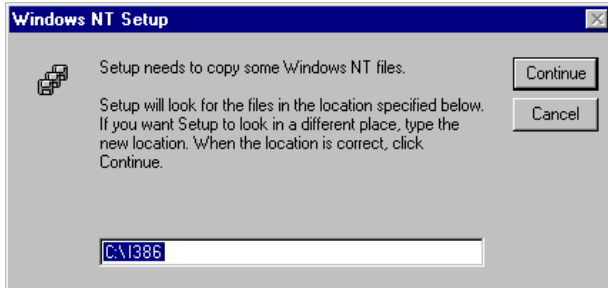

- Enter drive "C:\I386" and click "Continue".

After a couple of files have been copied, there is a message indicating that the driver for the Loopback-Adapter has been installed.

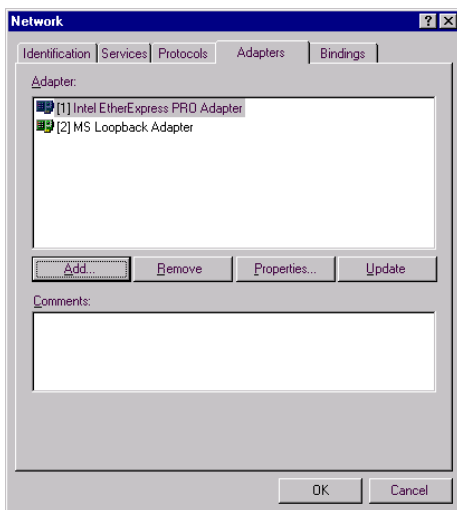

The installed network drivers are shown. The driver for the network card must be uninstalled:

- Select Etherexpress network driver
- Click on button *Remove*.
- Confirm query "This action will permanently remove the component from the system...Do you still wish to continue?" with "YES".

The network driver of the installed network card is removed.

- Leave the menu with "Close".



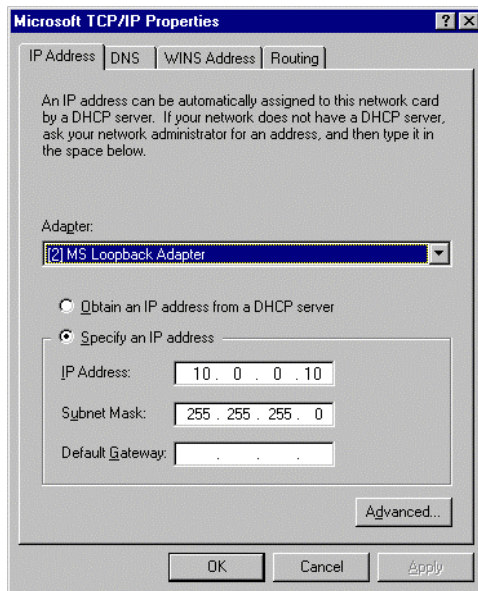

Then the entry of the IP address is required.

- Leave selection "Adapter" unchanged.
- Click on "Specify an IP address" .
- Enter the following IP address and subnet mask:  
**IP address**      **10.0.0.10**  
**subnet mask**    **255,255,255,0** .
- Confirm with "OK".

The request to restart the computer appears.

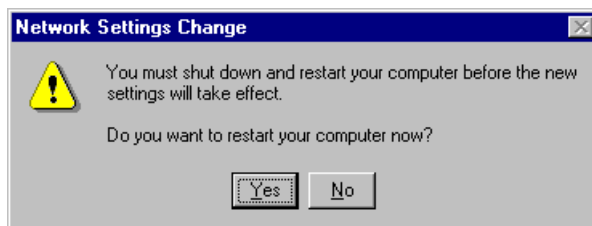

- Answer the query "Do you want to restart..." with "No".

Finally, the following steps are required:

- To disable the start request for user and password, the autologin mechanism has to be enabled (see section "*Re-enabling the Autologin-mechanism*") **before** the service pack is installed.
- Then reinstall the "**Service Pack 5**" of Windows NT (see chapter 1, section "Installing Windows-NT Software").
- If the instrument is equipped with the firmware applications FS-K3 (Software for Measurement of Noise Figure and Gain) or FS-K4 (Software for Phase Noise Measurement), the modified IP address must also be entered into the configuration of these programs (see documentation of firmware applications).

Note:

*If the service pack is not installed although there is no B20 option, the following error message will be displayed: "At least one service or driver failed during system startup..." **In this case, the network installation is not fully operational.***

*To prevent faults, it is therefore indispensable to reinstall the service pack (see chapter 1, section "Installing the Windows NT Software ")*

## Operating the Instrument on the Network

After the network support has been installed, it is possible to exchange data between the instrument and other computers and to use printers in the network.

A prerequisite to the network operation is the appropriate access rights for the required network resources. Resources may be file directories of other computers or also central printers.

Access rights can be obtained from the network or server administrator. In that respect it is necessary to obtain the network name of the resource as well as the corresponding access rights.

In order to avoid misuse, the resources are protected by passwords. Normally, every entitled user of the resources is assigned a user name that is also protected by a password. Resources can then be assigned to this user. It is possible to determine the type of data access, ie whether data can only be read or also written, as well as shared data access. Depending on the network operating system, different types of usage are possible.

### NOVELL Networks

The operating system NETWARE from NOVELL is a server based system. Data cannot be exchanged between individual workstations; the data transfer takes place between the PC and a server. This server provides memory space and the connection to network printers. On a server, data are organized in directories as under DOS and mapped to the workstation as virtual drives. A virtual drive behaves like an additional hard disk on the workstation, and the data can be edited accordingly. Network printers can also be addressed like normal printers.

There are two versions of the NOVELL network operating system: bindery-based (for NETWARE 3) and NDS-based (more recent NETWARE versions). In the case of the older version, NETWARE 3, each server manages its resources on its own and is independent. A user must be managed on each server separately. In the case of NDS based versions, all resources in the network are managed together in the NDS (NOVELL DIRECTORY SERVICE). The user must log into the network only once and is given access to the resources according to his access rights. The individual resources and users are managed as objects in a hierarchical tree (NDS TREE). The position of the object in the tree is referred to as "CONTEXT" with NETWARE and must be known for access to the resources.

### MICROSOFT Network

In case of a MICROSOFT network, data can be exchanged both between workstations (peer to peer) and between workstations and servers. The latter can supply access to files and connection to the printers. On a server, data are organized in directories as under DOS and mapped to the workstation as virtual drives. A virtual drive behaves like an additional hard disk on the workstation, and the data can be edited accordingly. Network printers can also be addressed like normal printers. A connection is possible to DOS, WINDOWS FOR WORKGROUPS, WINDOWS95, WINDOWS NT.

## Defining Users

After the network driver software has been installed, the instrument will output an error message on the next power-on, as there is no user called "Instrument" (= user name for NT autologin) in the network. It is therefore necessary to define a common user for Windows NT and the network and to disable the autologin-mechanism subsequently.

The definition of new users in the network is done by the network administrator. For definition of a new user on the instrument, the User Manager is required:

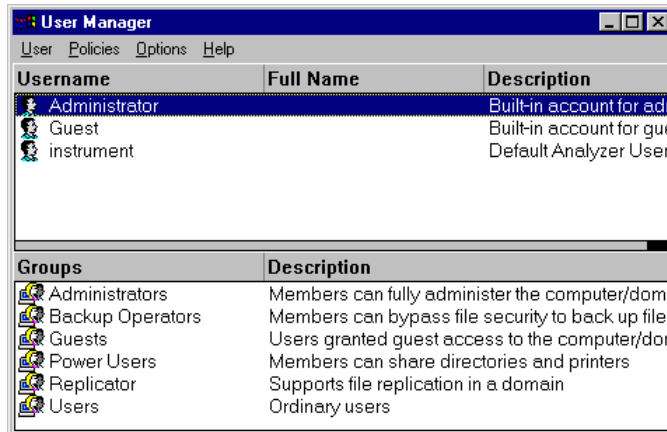

- Use the key combination <CTRL> <ESC> to call the Windows-NT start menu.
  - Click on "Programs", "Administrative Tools (Common)" and "User Manager" one after the other.
- The "User Manager" menu opens.

- Select User "instrument".
- Click on the "User" menu and select "Copy...".

The menu for entering the user data will appear.

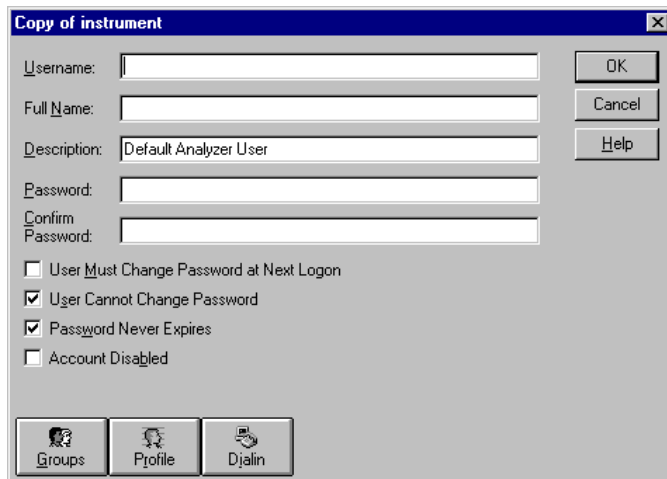

- Fill in the lines
    - "Username"
    - "Password and
    - "Confirm Password"
- and terminate the data entry with "OK".
- The user data must comply with the settings on the network.

### Only NOVELL network: Configure NOVELL Client

- Use the key combination <CTRL> <ESC> to call the Windows NT start menu.
- Click on "Settings", "Control Panel" and "CSNW" one after the other.

#### Bindery login (NOVELL 3.x)

- Click on "Preferred Server".
- Select the NOVELL server where the user is configured using "Select Preferred Server".

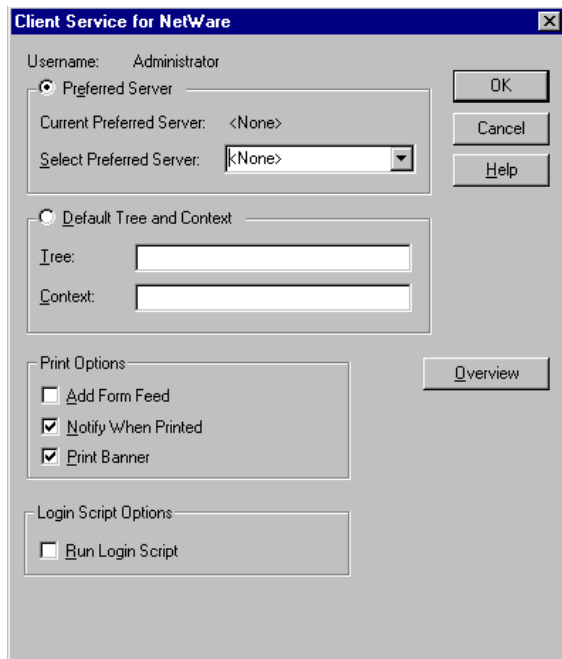

### NDS login (versions 4.x and higher)

- Click on "Default Tree and Context".
- Enter the NDS Tree under "Tree" and the hierarchical path where the user is defined under "Context".

**Note:** *This data can be obtained from the network administrator.*

## Login in the Network

The user automatically logs into the network with the registration in the operating system. As a prerequisite, the user name and the password must be identical under Windows NT and on the network.

## Disabling the Autologin-mechanism

Upon delivery, the instrument is configured for automatic login into Windows NT. This mechanism must be disabled if the instrument is operated in a network, since the default user name ("instrument") and the password normally are not identical to those of the network account.

To disable the autologin mechanism, proceed as follows:

- Open the NT start menu by means of <CTRL><ESC>.
- Select the menu item "RUN". A dialog box opens.
- Enter the command "D:\USER\NO\_AUTOLOGIN.REG" into the dialog box and confirm with <ENTER>.

The autologin mechanism is disabled. When the instrument is rebooted, a prompt for user name and password will appear before the instrument firmware is started.

## Re-enabling the Autologin-mechanism

To enable the autologin mechanism again, proceed as follows:

- Open the NT start menu by means of <CTRL><ESC>.
- Select the menu item "RUN". A dialog box opens.
- Enter the command "D:\USER\AUTOLOGIN.REG" into the dialog box and confirm with <ENTER>.

The autologin mechanism is reenabled and is active when the instrument is rebooted the next time.

## Using Network Drives

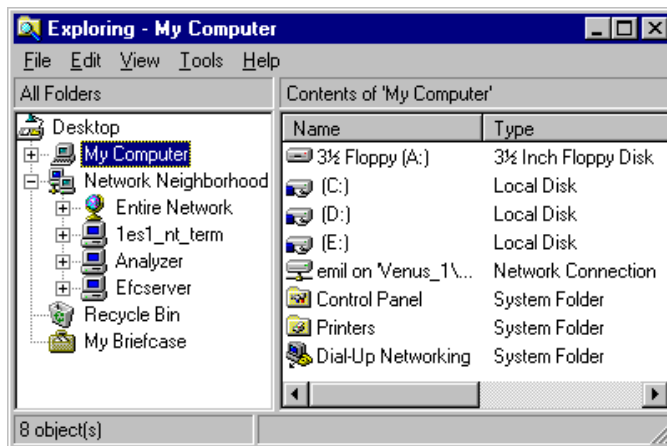

### Mapping a network drive:

- Use the key combination <CTRL> <ESC> to call the Windows NT start menu.
- Click on "Programs", "Windows NT Explorer" one after the other.
- Click on the line "Network Neighborhood" in the overview "All Directories".

An overview of the available network drives is displayed.

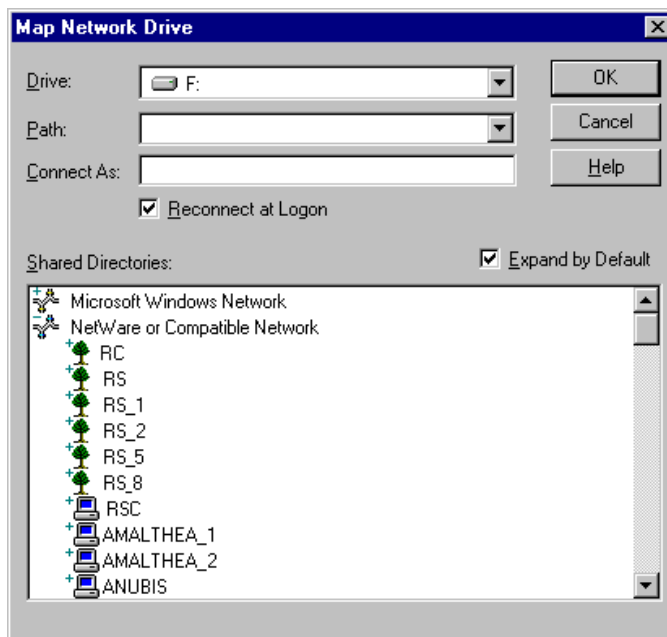

- Click on "Tools" and then "Map Network Drive".

The network paths available in the network are displayed in the overview "Shared Directories:".

- Mark the desired network path.

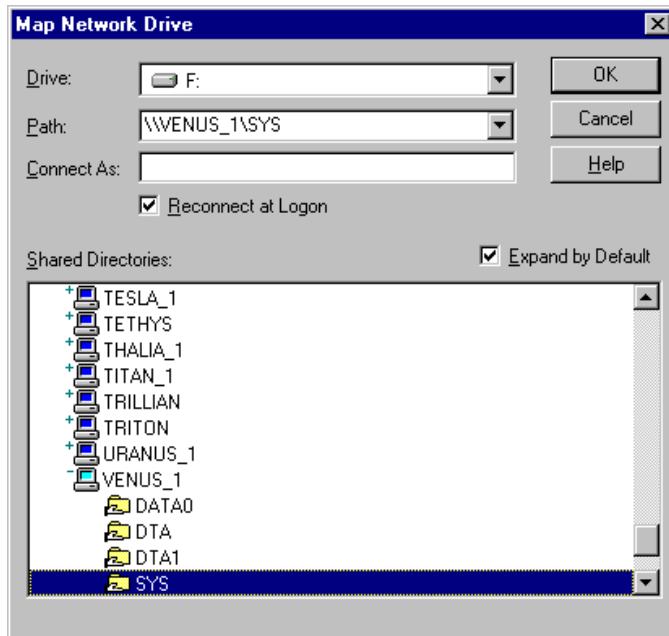

- Select the appropriate drive under "Drive:".
- Activate "Reconnect at Logon:" if the connection is to be set up automatically each time the instrument is started.
- Use "OK" to connect the network path with the selected drive.

The user name and the password are queried. Then the drive will appear in the overview "All Directories" of the explorer.

**Note:** Only drives in the network can be connected that the user has the appropriate access rights for.

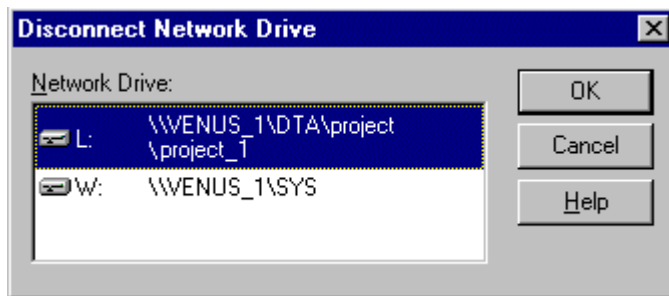

#### Disconnecting a network drive:

- Click on "Tools" in the Explorer and then "Disconnect Network Drive".
- Select the drive to be disconnected under "Network Drive:".
- Disconnect the drive using "OK". The security prompt must be answered with "Yes".

## Printing on a Network Printer

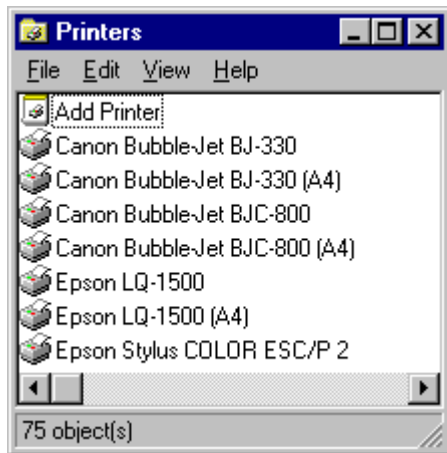

- Press the *HCOPY* key.  
The *HCOPY* menu opens.
- Press the *NEXT* key.  
The *HCOPY* submenu opens.
- Press the *INSTALL PRINTER* softkey.  
The printer window opens.
- Double-click on the line "Add Printer".  
The "Add Printer Wizard" window opens. It guides through the following printer driver installation.

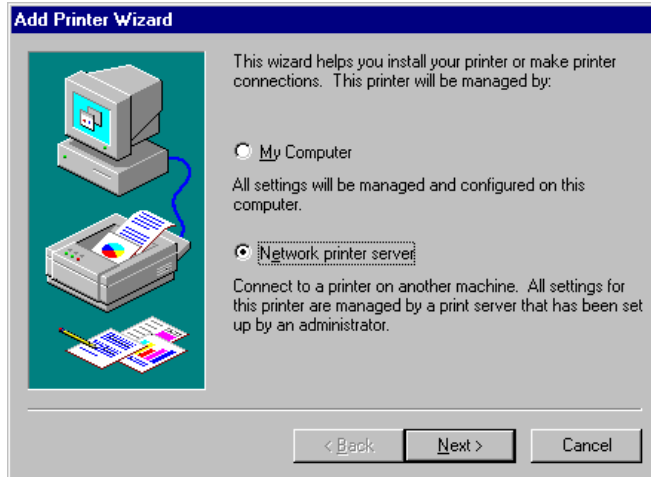

- Click on "Network Printer server" first and then on "Next".  
The choice of enabled printers appears.

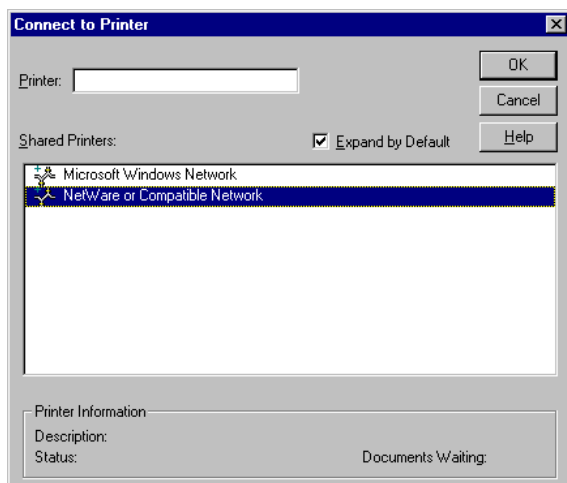

- Mark the printer and select using "OK".
- Confirm the following prompt to install a suitable printer driver using "OK".  
The choice of printer drivers appears. The left table shows the manufacturers, the right one the available printer drivers.

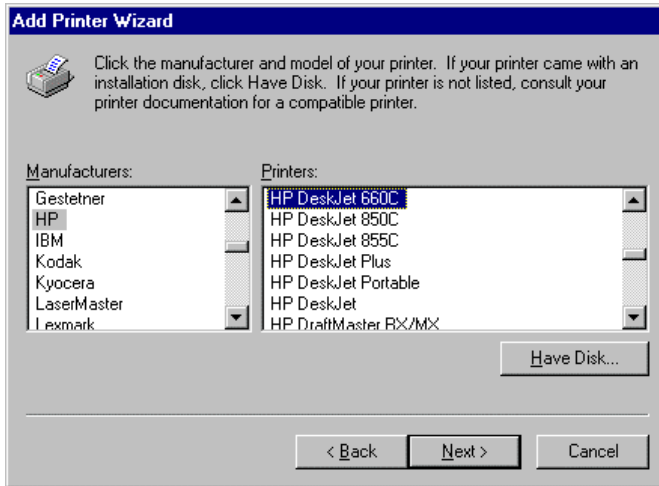

- Mark the manufacturer in the "Manufacturers" table and then the printer driver in the "Printers" table.

**Note:**

*If the desired type of the output device does not appear in the list, the driver has not yet been installed on the instrument. In this case, click on the "HAVE DISK" button. A prompt appears, requesting the user to insert a disk with the respective printer driver. Then press "OK" and select the desired printer driver. After the installation, "Service Pack 5" must be reinstalled (see section "Installing the Windows NT Software")*

- Click on "Next".

If one or more printers are already installed, this window will ask whether the just installed printer is to be selected as standard printer for the Windows NT applications (Do you want your Windows-based programs to use this printer as default printer?). "No" is set as default.



- Complete the installation of the printer driver by means of "Finish".

**Note:**

*If the prompt to specify the path to the printer driver appears after clicking on "Finish", the Service Pack must be reinstalled after this printer installation (see Chapter 1, section "Computer Function - Installing the Windows NT Software").*

Finally the instrument needs to be configured for use of the installed network printer using softkeys DEVICE 1 and DEVICE 2 in the Hardcopy Main Menu.



## Remote Data Transfer with TCP/IP Services

The protocol TCP/IP allows the transfer of files between different computer systems. This requires a program running on the two computers that controls this data transfer. It is not necessary that the same operating or file system is used by both computers. For example, a file transfer between DOS/WINDOWS and UNIX is possible. One of the two partners must be configured as Host and the other one as Client. However, they may as well change their roles. Usually, the system which is able to perform several processes at the same time will play the host role. The file transfer program usually used under TCP/IP is FTP (File Transfer Protocol). An FTP host is installed as standard on the majority of UNIX systems.

If the TCP/IP services are installed, a terminal connection is possible using "Start" - "Programs" - "Accessories" - "Telnet" or a data transfer via FTP by means of "Start" - "Run" "ftp" - "OK". Thus all computer systems supporting these universal protocols can be addressed (UNIX, VMS, ...).

For further information please refer to the corresponding NT literature.

### File Transfer via FTP

The total scope of functions and commands is described in the FTP literature. The following table therefore only contains the major functions:

#### Setting up the connection

---

Click on "Start" and then "Run" in the task bar

The DOS command

```
FTP
```

starts the program.

The command

```
OPEN <xx.xx.xx.xx>
```

sets up the connection.

xx.xx.xx.xx = IP address e.g. 89.0.0.13

---

#### Data transfer

The command

```
PUT <file name>
```

transfers the data to the target system.

The command

```
GET <file name>
```

transfers the data from the target system.

The command

```
TYPE B
```

transfers the data in BINARY format, no conversion takes place.

The command

```
TYPE A
```

transfers the data in ASCII format, converting control characters so that text files can also be read on the target system.

Examples:

```
PUT C:\AUTOEXEC.BAT
```

sends the file AUTOEXEC.BAT to the target system.

```
LCD DATA
```

changes the current directory on the local machine to subdirectory DATA

```
CD SETTING
```

changes to the subdirectory SETTING on the target system

file name= File name e.g. DATA.TXT

**Changing the directories**

The command

`LCD <path>`

changes the directory on the local machine as with DOS.

The command

`LDIR`

shows the directory contents on the local machine.

These commands refer to the file system of the ESPI. If the `L` is omitted ahead of the commands, they apply to the target system.

## RSIB Interface

The instrument is equipped with an RSIB interface as standard, which enables controlling of the instrument by means of Visual C++ and Visual Basic programs, but also by using the Windows applications WinWord and Excel, or National Instruments LabView, LabWindows/CVI and Agilent VEE. The control applications run on an external computer in the network.

A Unix operating system can be installed on an external computer in addition to a Windows operating system. In this case, the control applications are created either in C or C++. The supported Unix operating systems include:

- Sun Solaris 2.6 Sparc Station
- Sun Solaris 2.6 Intel Platform
- Red Hat Linux 6.2 x86 Processors

## Remote Control via RSIB Interface

### Windows Environment

In order to be able to access the measuring instruments via the RSIB interface, the file `RSIB32.DLL` must be copied into the Windows `system32` directory or into the directory of the control applications. For 16-bit applications, the file `RSIB.DLL` must be additionally copied into the directories mentioned. The files `RSIB.DLL` and `RSIB32.DLL` are included on the instrument in directory `D:\R_S\Instr\RSIB`.

For the different programming languages there are files available that contain the declarations of the DLL functions and the definition of the error codes.

Visual Basic (16 bit):	'RSIB.BAS'	(D:\R_S\Instr\RSIB)
Visual Basic (32 bit):	'RSIB32.BAS'	(D:\R_S\Instr\RSIB)
C/C++:	'RSIB.H'	(D:\R_S\Instr\RSIB)

For C and C++ programs, import libraries are additionally available.

Import library for RSIB.DLL:	RSIB.LIB'	(D:\R_S\Instr\RSIB)
Import library for RSIB32.DLL:	RSIB32.LIB'	(D:\R_S\Instr\RSIB)

The control is performed using the Visual C++ or Visual Basic programs, WinWord, Excel, LabView, LabWindows/CVI or Agilent VEE. Any application which is able to load a DLL can use the RSIB interface. The programs use the IP address of the instrument to set up the connection.

**Via VisualBasic:**        `ud = RSDLLibfind ("82.1.1.200", ibsta, iberr, ibcntl)`

Return to manual operation is possible via the front panel (*LOCAL* key) or via the RSIB interface:

**Via RSIB:**                `ud = RSDLLibloc (ud, ibsta, iberr, ibcntl) ;`  
                               `or`  
                               `ud = RSDLLibonl (ud, 0, ibsta, iberr, ibcntl) ;`

## Unix Environment

In order to access the measuring equipment via the RSIB interface, copy the `librsib.so.X.Y` file to a directory for which the control application has read rights. `X.Y` in the file name indicates the version number of the library, for example `1.0`.

The `librsib.so.X.Y` library is created as a *shared library*. The applications using the library have nothing to do with versions. They simply link the library with the `lrsib` option. The following instructions have to be observed so that linking can be successfully performed and the library can be found during the program run:

File link:

- Use the operating system command `ln` to create a file with the link name `librsib.so` and pointing to `librsib.so.X.Y` in a directory for which the control application has read rights. Example:

```
$ ln -s /usr/lib/librsib.so.1.0 /usr/lib/librsib.so
```

Linker options for creating applications:

- `-lrsib`: import library
- `-Lxxx`: path information where the import library can be found. This is where the above file link has been created. Example: `-L/usr/lib`.

Additional linker options for creating applications (only under Solaris):

- `-Rxxx`: path information where the library is searched for during the program run:  
`-R/usr/lib`.

Run-time environment:

- Set environment variable `LD_RUN_PATH` to the directory in which the file link has been created. This is necessary only if `librsib.so` cannot be found in the standard search path of the operating system and the `-R` linker option (only Solaris) was not specified.

For C/C++ programming, the declarations of the library functions and the definition of error codes are contained in:

```
C/C++:          'RSIB.H'          (D:\R_S\Instr\RSIB)
```

## RSIB Interface Functions

This chapter lists all functions of the DLL "RSIB.DLL" or "RSIB32.DLL" or "librsib.so", which allow to produce control applications.

### Overview of Interface Functions

The library functions are adapted to the interface functions of National Instruments for GPIB programming. The functions supported by the libraries are listed in the following table.

Function	Description
RSDLLibfind()	Provides a handle for access to a device.
RSDLLibwrt()	Sends a zero-terminated string to a device.
RSDLLilwrt()	Sends a certain number of bytes to a device.
RSDLLibwrff()	Sends the contents of a file to a device.
RSDLLibrd()	Reads data from a device into a string.
RSDLLilrd()	Reads a certain number of bytes from a device.
RSDLLibrdf()	Reads data from a device into a file.
RSDLLibtmo()	Sets timeout for RSIB functions
RSDLLibsre()	Switches a device into the local or remote state
RSDLLibloc()	Temporarily switches a device into the local state
RSDLLibeot()	Enables/disables the END message for write operations.
RSDLLibrsp()	Performs a serial poll and provides the status byte.
RSDLLibonl()	Sets the device On/Offline.
RSDLLTestSrqr()	Checks whether a device has generated an SRQ.
RSDLLWaitSrqr()	Waits until a device generates an SRQ.
RSDLLSwapBytes	Swaps the byte sequence for binary numeric display (only required for non-Intel platforms)

## Variables `ibsta`, `iberr`, `ibcntl`

As with the National Instruments interface, the successful execution of a command can be checked by means of the variables `ibsta`, `iberr` and `ibcntl`. For this purpose, all RSIB functions are assigned references to these three variables.

### Status word - `ibsta`

The status word `ibsta` provides information on the status of the RSIB interface. The following bits are defined:

Bit designation	Bit	Hex code	Description
ERR	15	8000	Is set when an error has occurred on calling a function. If this bit is set, <code>iberr</code> contains an error code which specifies the error in greater detail.
TIMO	14	4000	Is set when a timeout has occurred on calling a function.
CMPL	8	0100	Is set if the response of the GPIB parser has been read out completely. If a parser response is read out with the function <code>RSDLLi1rd()</code> and the length of the buffer is insufficient for the answer, the bit will be cleared.

### Error variable - `iberr`

If the ERR bit (8000h) is set in the status word, `iberr` contains an error code which allows to specify the error in greater detail. Extra error codes are defined for the RSIB interface, independent of the National Instruments interface.

Error	Error code	Description
IBERR_CONNECT	2	Setup of the connection to the measuring instrument has failed.
IBERR_NO_DEVICE	3	A function of the interface has been called with an illegal device handle.
IBERR_MEM	4	No empty memory available
IBERR_TIMEOUT	5	Timeout has occurred.
IBERR_BUSY	6	The RSIB interface is blocked by a still running function.
IBERR_FILE	7	Error when reading or writing to a file.
IBERR_SEMA	8	Error upon creating or assigning a semaphore (only under Unix)

### Count variable - `ibcntl`

The variable `ibcntl` is updated with the number of transferred bytes each time a read or write function is called.

## Description of Interface Functions

### RSDLLibfind()

The function provides a handle for access to the device with the name `udName`.

**VB format:**       Function RSDLLibfind (ByVal udName\$, ibsta%, iberr%, ibcntl&)  
                  As Integer

**C-format:**       short WINAPI RSDLLibfind( char far \*udName, short far \*ibsta,  
                  short far \*iberr, unsigned long far \*ibcntl)

**C format (Unix):** short RSDLLibfind( char \*udName, short \*ibsta, short \*iberr,  
                  unsigned long \*ibcntl)

**Parameter:**     udName                IP address of device

**Example:**       ud = RSDLLibfind ("89.10.38.97", ibsta, iberr, ibcntl)

The function must be called prior to all other functions of the interface.

As return value, the function provides a handle that must be indicated in all functions for access to the device. If the device with the name `udName` is not found, the handle has a negative value.

### RSDLLibwrt

This function sends data to the device with the handle `ud`.

**VB format:**       Function RSDLLibwrt (ByVal ud%, ByVal Wrt\$, ibsta%, iberr%,  
                  ibcntl&) As Integer

**C format:**       short WINAPI RSDLLibwrt( short ud, char far \*Wrt, short far  
                  \*ibsta, short far \*iberr, unsigned long far \*ibcntl )

**C format (Unix):** short RSDLLibwrt( short ud, char \*Wrt, short \*ibsta, short  
                  \*iberr, unsigned long \*ibcntl )

**Parameter:**     ud                    Device handle  
                  Wrt                   String sent to the device.

**Example:**       RSDLLibwrt(ud, "SENS:FREQ:STAR?", ibsta, iberr, ibcntl)

This function allows to send setting and query commands to the measuring instruments. Whether the data is interpreted as a complete command can be set using the function `RSDLLibeot()`.

### RSDLLilwrt

This function sends `Cnt` bytes to a device with the handle `ud`.

**VB format:**       Function RSDLLilwrt (ByVal ud%, ByVal Wrt\$, ByVal Cnt&,  
                  ibsta%, iberr%, ibcntl&) As Integer

**C format:**       short WINAPI RSDLLilwrt( short ud, char far \*Wrt,  
                  unsigned long Cnt, short far \*ibsta, short far \*iberr,  
                  unsigned long far \*ibcntl)

**C format (Unix):** short RSDLLilwrt( short ud, char \*Wrt, unsigned long Cnt,  
                  short \*ibsta, short \*iberr, unsigned long \*ibcntl)

**Parameter:**     ud                    Device handle  
                  Wrt                   String sent to the GPIB parser.  
                  Cnt                   Number of bytes sent to the device.

**Example:**       RSDLLilwrt (ud, '.....', 100, ibsta, iberr, ibcntl)

Like `RSDLLibwrt()` this function sends data to a device. The only difference is that binary data can be sent as well. The length of the data is not determined by a zero-terminated string, but by the indication of `Cnt` bytes. If the data is to be terminated with EOS (0Ah), the EOS byte must be appended to the string.

## RSDLLibwrtf

This function sends the contents of a file `file$` to the device with the handle `ud`.

**VB format:** Function RSDLLibwrtf (ByVal ud%, ByVal file\$, ibsta%, iberr%, ibcntl&) As Integer

**C format:** short WINAPI RSDLLibwrt( short ud, char far \*Wrt, short far \*ibsta, short far \*iberr, unsigned long far \*ibcntl )

**C format (Unix):** short RSDLLibwrt( short ud, char \*Wrt, short \*ibsta, short \*iberr, unsigned long \*ibcntl )

**Parameter:** ud Device handle  
file File the contents of which are sent to the device.

**Example:** RSDLLibwrtf(ud, "C:\db.sav", ibsta, iberr, ibcntl)

This function allows to send setting and query commands to the measuring instruments. Whether the data is interpreted as complete command can be set using the function RSDLLibeot().

## RSDLLibrd()

The function reads data from the device with the handle `ud` into the string `Rd`.

**VB format:** Function RSDLLibrd (ByVal ud%, ByVal Rd\$, ibsta%, iberr%, ibcntl&) As Integer

**C format:** short WINAPI RSDLLibrd( short ud, char far \*Rd, short far \*ibsta, short far \*iberr, unsigned long far \*ibcntl )

**C format (Unix):** short RSDLLibrd( short ud, char \*Rd, short \*ibsta, short \*iberr, unsigned long \*ibcntl )

**Parameter:** ud Device handle  
Rd String into which the read data is copied.

**Example:** RSDLLibrd (ud, Rd, ibsta, iberr, ibcntl)

This function fetches the responses of the GPIB parser to a query.

In the case of Visual Basic programming, a string of sufficient length must be generated before. This can be done during the definition of the string or using the command `Space$()`.

Generation of a string of the length 100:               - Dim Rd as String \* 100  
  - Dim Rd as String  
  Rd = Space\$(100)

## RSDLLilrd

This function reads `Cnt` bytes from the device with the handle `ud`.

**VB format:** Function RSDLLilrd (ByVal ud%, ByVal Rd\$, ByVal Cnt&, ibsta%, iberr%, ibcntl&) As Integer

**C format:** short WINAPI RSDLLilrd( short ud, char far \*Rd, unsigned long Cnt, short far \*ibsta, short far \*iberr, unsigned long far \*ibcntl )

**C format (Unix):** short RSDLLilrd( short ud, char \*Rd, unsigned long Cnt, short \*ibsta, short \*iberr, unsigned long \*ibcntl )

**Parameter:** ud Device handle  
cnt Maximum number of bytes copied from the DLL into the target string `Rd`.

**Example:** RSDLLilrd (ud, RD, 100, ibsta, iberr, ibcntl)

Like the function `RSDLLibrd()`, this function reads data from a device. The only difference is that in this case the maximum number of bytes to be copied into the target string `Rd` can be indicated by means of `Cnt`. This function prevents writing beyond the end of the string.



**RSDLLibrdf()**

Reads data from the device with the handle `ud` into the file `file`.

**VB format:** Function `RSDLLibrdf (ByVal ud%, ByVal file$, ibsta%, iberr%, ibcntl&) As Integer`

**C format:** `short WINAPI RSDLLibrd( short ud, char far *file, short far *ibsta, short far *iberr, unsigned long far *ibcntl )`

**C format (Unix):** `short RSDLLibrd( short ud, char *file, short *ibsta, short *iberr, unsigned long *ibcntl )`

**Parameter:** `ud` Device handle  
`file` File into which the read data is written.

**Example:** `RSDLLibrdf (ud, "c:\db.sav", ibsta, iberr, ibcntl)`

The file name may as well include a drive or path specification.

**RSDLLibtmo**

This function defines the timeout for a device. The default value for the timeout is set to 5 seconds.

**VB format:** Function `RSDLLibtmo (ByVal ud%, ByVal tmo%, ibsta%, iberr%, ibcntl&) As Integer`

**C format:** `short WINAPI RSDLLibtmo( short ud, short tmo, short far *ibsta, short far *iberr, unsigned long far *ibcntl )`

**C format (Unix):** `short RSDLLibtmo( short ud, short tmo, short *ibsta, short *iberr, unsigned long *ibcntl )`

**Parameter:** `ud` Device handle  
`tmo` Timeout in seconds

**Example:** `RSDLLibtmo (ud, 10, ibsta, iberr, ibcntl)`

**RSDLLibsre**

This function sets the device to the 'LOCAL' or 'REMOTE' state.

**VB format:** Function `RSDLLibsre (ByVal ud%, ByVal v%, ibsta%, iberr%, ibcntl&) As Integer`

**C format:** `short WINAPI RSDLLibsre( short ud, short v, short far *ibsta, short far *iberr, unsigned long far *ibcntl)`

**C format (Unix):** `short RSDLLibsre( short ud, short v, short *ibsta, short *iberr, unsigned long *ibcntl)`

**Parameter:** `ud` Device handle  
`v` State of device

0 - local

1 - remote

**Example:** `RSDLLibsre (ud, 0, ibsta, iberr, ibcntl)`

## RSDLLibloc

This function temporarily switches the device to the 'LOCAL' state.

**VB format:** Function RSDLLibloc (ByVal ud%, ibsta%, iberr%, ibcntl&) As Integer

**C format:** short WINAPI RSDLLibloc( short ud, short far \*ibsta, short far \*iberr, unsigned long far \*ibcntl)

**C format (Unix):** short RSDLLibloc( short ud, short \*ibsta, short \*iberr, unsigned long \*ibcntl)

**Parameter:** ud Device handle

**Example:** RSDLLibloc (ud, ibsta, iberr, ibcntl)

After switchover to LOCAL state, the instrument can be manually operated via the front panel. On the next access to the instrument by means of one of the functions of the library the instrument is switched again to the REMOTE state.

## RSDLLibeot

This function enables or disables the END message after write operations.

**VB format:** Function RSDLLibeot (ByVal ud%, ByVal v%, ibsta%, iberr%, ibcntl&) As Integer

**C format:** short WINAPI RSDLLibsre( short ud, short v, short far \*ibsta, short far \*iberr, unsigned long far \*ibcntl)

**C format (Unix):** short RSDLLibsre( short ud, short v, short \*ibsta, short \*iberr, unsigned long \*ibcntl)

**Parameter:** ud Device handle.  
v 0 - no END message  
1 - send END message

**Example:** RSDLLibeot (ud, 1, ibsta, iberr, ibcntl)

If the END message is disabled, the data of a command can be sent with several successive calls of write functions. The END message must be enabled again before sending the last data block.

## RSDLLibrsp

This function performs a serial poll and provides the status byte of the device.

**VB format:** Function RSDLLibrsp(ByVal ud%, spr%, ibsta%, iberr%, ibcntl&) As Integer

**C format:** short WINAPI RSDLLibrsp( short ud, char far\* spr, short far \*ibsta, short far \*iberr, unsigned long far \*ibcntl)

**C format (Unix):** short RSDLLibrsp( short ud, char \*spr, short \*ibsta, short \*iberr, unsigned long \*ibcntl)

**Parameter:** ud Device handle  
spr Pointer to status byte

**Example:** RSDLLibrsp(ud, spr, ibsta, iberr, ibcntl)

**RSDLLibonl**

This function switches the device to 'online' or 'offline' mode. When it is switched to 'offline' mode, the interface is released and the device handle becomes invalid. By calling RSDLLibfind again, the communication is set up again.

**VB format:** Function RSDLLibonl (ByVal ud%, ByVal v%, ibsta%, iberr%,  
ibcntl&) As Integer

**C format:** short WINAPI RSDLLibonl( short ud, short v, short far \*ibsta,  
short far \*iberr, unsigned long far \*ibcntl)

**C format:** short RSDLLibonl( short ud, short v, short \*ibsta, short  
\*iberr, unsigned long \*ibcntl)

**Parameter:** ud Device handle  
v Device state  
0 - local  
1 - remote

**Example:** RSDLLibonl(ud, 0, ibsta, iberr, ibcntl)

**RSDLLTestSRQ**

This function checks the status of the SRQ bit.

**VB format:** Function RSDLLTestSrq (ByVal ud%, Result%, ibsta%, iberr%,  
ibcntl&) As Integer

**C format:** short WINAPI RSDLLTestSrq( short ud, short far \*result, short  
far \*ibsta, short far \*iberr, unsigned long far \*ibcntl)

**C format (Unix):** short RSDLLTestSrq( short ud, short \*result, short \*ibsta,  
short \*iberr, unsigned long \*ibcntl)

**Parameter:** ud Device handle  
result Reference to an integer value in which the library returns  
the status of the SRQ bit.  
0 - no SRQ  
1 - SRQ active, device requests service

**Example:** RSDLLTestSrq (ud, result%, ibsta, iberr, ibcntl)

This function corresponds to the function RSDLLWaitSrq. The only difference is that RSDLLTestSRQ immediately returns the current status of the SRQ bit, whereas RSDLLWaitSrq waits for an SRQ to occur.

## RSDLLWaitSrq

This function waits until the device triggers an SRQ with the handle `ud`.

**VB format:** Function RSDLLWaitSrq (ByVal ud%, Result%, ibsta%, iberr%, ibcntl&) As Integer

**C format:** short WINAPI RSDLLWaitSrq( short ud, short far \*result, short far \*ibsta, short far \*iberr, unsigned long far \*ibcntl)

**C format (Unix):** short RSDLLWaitSrq( short ud, short \*result, short \*ibsta, short \*iberr, unsigned long \*ibcntl)

**Parameter:**

<code>ud</code>	Device handle
<code>result</code>	Reference to an integer value in which the library returns the status of the SRQ bit.
	0 - No SRQ has occurred during the timeout
	1 - SRQ has occurred during the timeout

**Example:** RSDLLWaitSrq( ud, result, ibsta, iberr, ibcntl );

The function waits until one of the following two events occurs.

- The measuring instrument triggers an SRQ
- No SRQ occurs during the timeout defined with `RSDLLibtmo()`

## RSDLLSwapBytes

This function changes the display of binary numbers on non-Intel platforms.

**VB format:** Not provided at present since it is required only on non-Intel platforms.

**C format:** void WINAPI RSDLLSwapBytes( void far \*pArray, const long size, const long count)

**C format (Unix):** void RSDLLSwapBytes( void \*pArray, const long size, const long count)

**Parameter:**

<code>pArray</code>	Array in which modifications are made
<code>size</code>	Size of a single element in <code>pArray</code>
<code>count</code>	Number of elements in <code>pArray</code>

**Example:** RSDLLSwapBytes( Buffer, sizeof(float), ibcntl/sizeof(float))

This function swaps the display of various elements from *Big Endian* to *Little Endian* and vice versa. It is expected that a coherent storage area of elements of the same file type (`size` byte) is transferred to `pArray`. This function has no effect on Intel platforms.

Different types of processor architecture store data in different byte sequences. For example, Intel processors store data in the reverse order of Motorola processors. Comparison of byte sequences:

Byte sequence	Use in	Display in memory	Description
Big Endian	Motorola processors, network standard	Most significant byte at least significant address	The <i>most significant</i> byte is at the left end of the word.
Little Endian	Intel processors	Least significant byte at least significant address	The <i>most significant</i> byte is at the right end of the word.

## Programming via the RSIB Interface

### Visual Basic

#### Programming hints:

- Access to the functions of the RSIB.DLL

To create Visual Basic control applications, the file RSIB.BAS must be added to a project for 16-bit Basic programs and the file RSIB32.BAS for 32-bit Basic programs (D:\R\_S\INSTR\RSIB) so that the functions of the RSIB.DLL or RSIB32.DLL can be accessed.

- Generating a response buffer

Prior to calling the functions `RSDLLibrd()` and `RSDLLilrd()`, a string of sufficient length must be generated. This is possible either by defining the string or using the command `Space$()`.

Generating a string of the length 100:       - Dim Response as String \* 100  
   - Dim Response as String  
   Response = Space\$(100)

If a response is to be output as a string from the measuring instrument, the appended blanks can be removed using the Visual Basic Function `RTrim()`.

#### Example:

```
Response = Space$(100)
Call RSDLLibrd(ud, Response, ibsta, iberr, ibcntl)
Response = RTrim(Response)
' Output of Response
```

- Reading out trace data in real format

Using the function declarations in the file RSIB.BAS or RSIB32.BAS the responses of the device can be assigned to one string only. If the data are to be read into an array with float values, the header and the useful data must be read out with separate function calls.

#### Example of a header

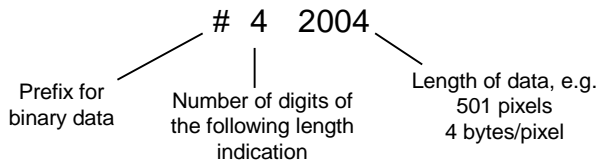

In order to enable the trace data to be directly read into a float array, a special function declaration must be created.

```
Declare Function RSDLLilrdTraceReal Lib "rsib32.dll" Alias "RSDLLilrd"
(ByVal ud%, Rd As Single, ByVal Cnt&, ibsta%, iberr%, ibcntl&) As Integer
```

## Example:

```

Dim ibsta As Integer      ' Status variable
Dim iberr As Integer     ' Error variable
Dim ibcntl As Long      ' Count variable
Dim ud As Integer       ' Handle for measuring instrument
Dim Result As String    ' Buffer for simple results
Dim Digits As Byte      ' Number of digits of length indication
Dim TraceBytes As Long  ' Length of trace data in bytes
Dim TraceData(501) As Single ' Buffer for floating point
                          ' Binary data

' Set up connection to instrument
ud = RSDLLibfind("89.10.38.97", ibsta, iberr, ibcntl)

' Query trace data in real format
Call RSDLLibwrt(ud, "FORM:DATA REAL,32", ibsta, iberr, ibcntl)
Call RSDLLibwrt(ud, "TRACE? TRACE1", ibsta, iberr, ibcntl)

' Read number of digits of length indication
Result = Space$(20)
Call RSDLLilrd(ud, Result, 2, ibsta, iberr, ibcntl)
Digits = Val(Mid$(Result, 2, 1))

' Read length indication
Result = Space$(20)
Call RSDLLilrd(ud, Result, Digits, ibsta, iberr, ibcntl)
TraceBytes = Val(Left$(Result, Digits)) 'and store

' Read out trace data
Call RSDLLilrdTraceReal(ud, TraceData(0), TraceBytes, ibsta, iberr, ibcntl)

```

**Programming examples:**

- In this example, the start frequency of the instrument is queried.

```

Dim ibsta As Integer      ' Status variable
Dim iberr As Integer     ' Error variable
Dim ibcntl As Long      ' Count variable
Dim ud As Integer       ' Handle for measuring instrument
Dim Response As String   ' Response string

' Set up connection to measuring instrument
ud = RSDLLibfind("89.10.38.97", ibsta, iberr, ibcntl)
If (ud < 0) Then
    ' Error treatment
End If

' Send query command
Call RSDLLibwrt(ud, "FREQ:START?", ibsta, iberr, ibcntl)

' Provide space for response
Response = Space$(100)

' Read response from measuring instrument
Call RSDLLibrd(ud, Response, ibsta, iberr, ibcntl)

```

- In this example, a Save/Recall of the instrument setups is performed.

```
Dim ibsta As Integer      ' Status variable
Dim iberr As Integer      ' Error variable
Dim ibcntl As Long       ' Count variable
Dim ud As Integer        ' Handle for measuring instrument
Dim Cmd As String        ' Command string

' Set up connection to measuring instrument
ud = RSDLLibfind("89.10.38.97", ibsta, iberr, ibcntl)
If (ud < 0) Then
    ' Error treatment
End If

' Request instrument settings
Cmd = "SYST:SET?"
Call RSDLLibwrt(ud, Cmd, ibsta, iberr, ibcntl)

' Store instrument response in file
Call RSDLLibrdf(ud, "C:\db.sav", ibsta, iberr, ibcntl)

' Reset instrument
Call RSDLLibwrt(ud, "*RST", ibsta, iberr, ibcntl)

' and restore the previous settings
' to this end disable the END message
Call RSDLLibeot(ud, 0, ibsta, iberr, ibcntl)
' first send off command
Call RSDLLibwrt(ud, "SYST:SET ", ibsta, iberr, ibcntl)
' enable the END message again
Call RSDLLibeot(ud, 1, ibsta, iberr, ibcntl)
' and send the data
Call RSDLLibrwrtf(ud, "C:\db.sav", ibsta, iberr, ibcntl)
```

## Visual Basic for Applications (Winword and Excel)

### Programming hints:

The programming language Visual Basic for Applications (VBA) is supported as a macro language by various manufacturers. The programs Winword and Excel use this language for the versions Winword 97 or Excel 5.0 and higher.

For macros created with Visual Basic for Applications, the same hints are valid as for Visual Basic Applications.

### Programming example:

- Using the macro `QueryMaxPeak` a single sweep with subsequent query of the maximum peak is performed. The result is entered in a Winword or Excel document.

```
Sub QueryMaxPeak()

    Dim ibsta As Integer      ' Status variable
    Dim iberr As Integer      ' Error variable
    Dim ibcnt1 As Long        ' transferred characters
    Dim ud As Integer         ' Unit Descriptor (handle)for instrument
    Dim Response As String    ' Response string

    ' Set up connection to measuring instrument
    ud = RSDLLibfind("89.10.38.97", ibsta, iberr, ibcnt1)
    If (ud < 0) Then
        Call MsgBox("Device with address 89.10.38.97 could" & _
            "not be found", vbExclamation)
    End
End If

    ' Determine maximum peak in the range 1-2MHZ
    Call RSDLLibwrt(ud, "*RST", ibsta, iberr, ibcnt1)
    Call RSDLLibwrt(ud, "INIT:CONT OFF", ibsta, iberr, ibcnt1)
    Call RSDLLibwrt(ud, "FREQ:START 1MHZ", ibsta, iberr, ibcnt1)
    Call RSDLLibwrt(ud, "FREQ:STOP 2MHZ", ibsta, iberr, ibcnt1)
    Call RSDLLibwrt(ud, "INIT:IMM;*WAI", ibsta, iberr, ibcnt1)
    Call RSDLLibwrt(ud, "CALC:MARK:MAX;Y?", ibsta, iberr, ibcnt1)
    Response = Space$(100)
    Call RSDLLibrd(ud, Response, ibsta, iberr, ibcnt1)
    Response = RTrim(Response) ' Cut off space

    ' Insert value in current document (Winword)
    Selection.InsertBefore (Response)
    Selection.Collapse (wdCollapseEnd)

    ' Terminate connection to measuring instrument
    Call RSDLLibonl(ud, 0, ibsta, iberr, ibcnt1)

End Sub
```

The entry of the peak value in the Winword document can be replaced as follows for Excel:

```
' Insert value in current document (Excel)
ActiveCell.FormulaR1C1 = Response
```



## C / C++

### Programming hints:

- Access to the functions of the RSIB32.DLL (Windows platforms)

The functions of the `RSIB32.DLL` are declared in the header file `RSIB.H`. The DLL functions can be linked to a C/C++ program in different ways.

1. Enter one of the supplied import libraries (`RSIB.LIB` or `RSIB32.LIB`) into the linker options.
2. Load the library using the function `LoadLibrary()` during runtime and determine the function pointers of the DLL functions using `GetProcAddress()`. Before the end of the program, the `RSIB.DLL` must be unloaded again using the function `FreeLibrary()`.

When import libraries are used, the DLL is automatically loaded immediately before the application is started. At the end of the program, the DLL is unloaded again unless it is still used by other applications.

- Access to `libsib.so` functions (Unix platforms)

The functions of `libsib.so` are declared in the header file `RSIB.H`. Upper/lower case characters for file names are typically observed under Unix. The library functions are linked to a C/C++ program by entering the `-libsib` linker option.

The *shared library* `libsib.so` is automatically loaded on starting the application. The accessibility (for example via standard path) of the library must be ensured. Refer to the beginning of this main chapter under „Unix Environment“.

- Query of strings

If instrument responses are to be further processed as strings, a zero termination must be appended.

Example:

```
char buffer[100];
...
RSDLLibrd( ud, buffer, &ibsta, &iberr, &ibcntl );
buffer[ibcntl] = 0;
```

**Programming example:**

In the following C program example, a single sweep is started on the device with the IP address 89.10.38.97 and subsequently a marker is set to maximum level. Prior to the search for maximum, a synchronization to the end of the sweep is performed. For this purpose the command "\*OPC" (Operation complete) is used to create a service request at the end of the sweep, for which the control program waits with the function `RSDLLWaitSrq()`. Then the maximum is determined ("`CALC:MARK:MAX`") and the level read out ("`Y?`").

```
#define MAX_RESP_LEN 100

short          ibsta, iberr;
unsigned long  ibcntl;
short         ud;
short         srq;
char          MaxPegel[MAX_RESP_LEN];
char          spr;

// Determine handle for instrument
ud = RSDLLibfind( "89.10.38.97", &ibsta, &iberr, &ibcntl );

// if instrument exists
if ( ud >= 0 )
{
    // Set timeout for RSDLLWaitSrq() to 10 seconds
    RSDLLibtmo( ud, 10, &ibsta, &iberr, &ibcntl );

    // Activate SRQ generation via event status register (ESR)
    // and enable ESB bit in SRE register
    RSDLLibrwt( ud, "*ESE 1;*SRE 32", &ibsta, &iberr, &ibcntl );

    // Set single sweep, trigger sweep and use "*OPC" to cause
    // the generation of a service request at the end of the sweep
    RSDLLibrwt( ud, "INIT:CONT off;INIT;*OPC", &ibsta, &iberr, &ibcntl );

    // Wait for SRQ (end of sweep)
    RSDLLWaitSrq( ud, &srq, &ibsta, &iberr, &ibcntl );

    // Clear RQS/MSS bit
    RSDLLibrsp( ud, &spr, &ibsta, &iberr, &ibcntl );

    // if sweep is terminated
    if (srq)
    {
        // then set marker to first maximum and query the level
        RSDLLibrwt( ud, "CALC:MARK:MAX;Y?", &ibsta, &iberr, &ibcntl );
        RSDLLilrd( ud, MaxPegel, MAX_RESP_LEN, &ibsta, &iberr, &ibcntl );
        MaxPegel[ibcntl] = 0;
    }
    // End connection to instrument
    RSDLLibonl( ud, 0, &ibsta, &iberr, &ibcntl );
}
else
{
    ; // Error Instrument not found
}
}
```



## Contents - Chapter 5 "Remote Control - "Basics"

<b>5 Remote Control - Basics</b> .....	<b>5.1</b>
<b>Introduction</b> .....	<b>5.1</b>
<b>Getting Started</b> .....	<b>5.2</b>
<b>Starting Remote Control Operation</b> .....	<b>5.2</b>
Display Contents during Remote Control .....	5.2
Remote Control via IEC/IEEE Bus.....	5.3
Setting the Device Address .....	5.3
Return to Manual Operation .....	5.3
Remote Control via RS-232-Interface .....	5.4
Setting the Transmission Parameters .....	5.4
Return to Manual Operation .....	5.4
Limitations .....	5.4
Remote Control via Local Network (RSIB Interface) .....	5.5
Return to Manual Operation .....	5.5
<b>Messages</b> .....	<b>5.6</b>
IEC/IEEE-Bus Interface Messages.....	5.6
Device Messages (Commands and Device Responses) .....	5.6
<b>Structure and Syntax of the Device Messages</b> .....	<b>5.7</b>
SCPI Introduction.....	5.7
Structure of a Command .....	5.7
Structure of a Command Line.....	5.10
Responses to Queries .....	5.10
Parameters .....	5.11
Overview of Syntax Elements.....	5.12
<b>Instrument Model and Command Processing</b> .....	<b>5.13</b>
Input Unit .....	5.13
Command Recognition .....	5.14
Instrument Data Base and Instrument Hardware .....	5.14
Output Unit.....	5.15
Command Sequence and Command Synchronization.....	5.15
<b>Status Reporting System</b> .....	<b>5.16</b>
Structure of an SCPI Status Register .....	5.16
Overview of the Status Registers .....	5.18

---

Description of the Status Registers .....	5.19
Status Byte (STB) and Service Request Enable Register (SRE) .....	5.19
IST Flag and Parallel Poll Enable Register (PPE) .....	5.20
Event-Status Register (ESR) and Event-Status-Enable Register (ESE) .....	5.20
STATUS:OPERation Register .....	5.21
STATUS:QUEStionable Register .....	5.22
STATUS QUEStionable:ACPLimit Register .....	5.23
STATUS QUEStionable:FREQuency Register .....	5.24
STATUS QUEStionable:LIMit<1 2> Register .....	5.25
STATUS QUEStionable:LMARgin<1 2> Register .....	5.26
STATUS QUEStionable:POWer Register .....	5.27
STATUS-QUEStionable:SYNC Register .....	5.28
STATUS QUEStionable:TRANsducer Register .....	5.29
Application of the Status Reporting Systems.....	5.30
Service Request, Making Use of the Hierarchy Structure .....	5.30
Serial Poll .....	5.30
Parallel Poll.....	5.31
Query by Means of Commands.....	5.31
Error-Queue Query.....	5.31
Resetting Values of the Status Reporting System.....	5.32

## 5 Remote Control - Basics

In this chapter you'll find:

- instructions on how to put the ESPI into operation via remote control,
- a general introduction to remote control of programmable instruments. This includes the description of the command structure and syntax according to the SCPI standard, the description of command execution and of the status registers,
- diagrams and tables describing the status registers used in the ESPI.

In chapter 6, all remote control functions are described in detail. The subsystems are listed by alphabetical order according to SCPI. All commands and their parameters are listed by alphabetical order in the command list at the end of chapter 6.

Program examples for the ESPI can be found in chapter 7.

The remote control interfaces and their interface functions are described in Chapter 8.

### Introduction

The instrument is equipped with an IEC-bus interface according to standard IEC 625.1/IEEE 488.2 and a RS-232 interface. The connectors are located at the rear of the instrument and permits to connect a controller for remote control. In addition, with the option LAN Interface (FSP-B16) provided, the instrument can be operated in remote control via a local network.

The instrument supports the SCPI version 1997.0 (Standard Commands for Programmable Instruments). The SCPI standard is based on standard IEEE 488.2 and aims at the standardization of device-specific commands, error handling and the status registers (see section "SCPI Introduction"). The tutorial "Automatic Measurement Control – A tutorial on SCPI and IEEE 488.2" from John M. Pieper (R&S order number 0002.3536.00) offers detailed information on concepts and definitions of SCPI.

This section assumes basic knowledge of IEC/IEEE bus programming and operation of the controller. A description of the interface commands can be obtained from the relevant manuals. Remote control via network is described in chapter 4, section "RSIB Interface".

The requirements of the SCPI standard placed on command syntax, error handling and configuration of the status registers are explained in detail in the following sections. Tables provide a fast overview of the bit assignment in the status registers. The tables are supplemented by a comprehensive description of the status registers.

The program examples for IEC-bus programming are all written in VISUAL BASIC.

## Getting Started

The short and simple operating sequence given below permits fast putting into operation of the instrument and setting of its basic functions. As a prerequisite, the IEC/IEEE-bus address, which is factory-set to 20, must not have been changed.

1. Connect instrument and controller using IEC/IEEE-bus cable.
2. Write and start the following program on the controller:

```
CALL IBFIND("DEV1", receiver%)           'Open port to the instrument
CALL IBPAD(receiver%, 20)                'Inform controller about instrument address
CALL IBWRT(receiver%, '*RST;*CLS')       'Reset instrument

CALL IBWRT(receiver%, 'FREQ:CENT 100MHz') ' Set center frequency to 100 MHz
CALL IBWRT(receiver%, 'FREQ:SPAN 10MHz')  ' Set span to 10 MHz
CALL IBWRT(receiver%, 'DISP:TRAC:Y:RLEV -10dBm')
                                           ' Set reference level to -10 dBm
```

The instrument now performs a sweep in the frequency range of 95 MHz to 105 MHz in analyzer mode.

3. To return to manual control, press the *LOCAL* key at the front panel

## Starting Remote Control Operation

On power-on, the instrument is always in the manual operating state ("LOCAL" state) and can be operated via the front panel.

It is switched to remote control ("REMOTE" state)

IEC/IEEE-bus                    as soon as it receives an addressed command from a controller.

RS-232                         as soon as it receives the command "@REM" from a controller.

Local network (RSIB)         as soon as it receives an addressed command from a controller.

During remote control, operation via the front panel is disabled. The instrument remains in the remote state until it is reset to the manual state via the front panel or via remote control interfaces. Switching from manual operation to remote control and vice versa does not affect the remaining instrument settings.

## Display Contents during Remote Control

During remote control, only the LOCAL softkey appears, with which it is possible to return to manual operation.

In addition, the display of diagrams and results can be blanked out with the command "SYSTEM:DISPLAY:UPDATE OFF" (default in remote control) to obtain optimum performance during remote control operation.

During program execution it is recommended to activate the display of results by means of "SYSTEM:DISPLAY:UPDATE ON" so that it is possible to follow the changes in the device settings and the recorded measurement curves on the screen.

**Note:**     *If the instrument is exclusively operated in remote control, it is recommended to switch on the power-save mode (POWER SAVE). In this mode, the required display is completely switched off after a preset time.*

## Remote Control via IEC/IEEE Bus

### Setting the Device Address

In order to operate the instrument via the IEC-bus, it must be addressed using the set IEC/IEEE bus address. The IEC/IEEE bus address of the instrument is factory-set to 20. It can be changed manually in the *SETUP - GENERAL SETUP* menu or via IEC bus. Addresses 0 to 30 are permissible.

#### Manually:

- Call *SETUP - GENERAL SETUP* menu
- Enter desired address in table *GPIB-ADDRESS*
- Terminate input using the *ENTER* key

#### Via IEC/IEEE bus:

CALL IBFIND("DEV1", receiver%)	'Open port to the instrument
CALL IBPAD(receiver%, 20)	'Inform controller about old address
CALL IBWRT(receiver%, "SYST:COMM:GPIB:ADDR 18")	'Set instrument to new address
CALL IBPAD(receiver%, 18)	'Inform controller about new address

### Return to Manual Operation

Return to manual operation is possible via the front panel or the IEC/IEEE bus.

#### Manually:

- Press the *LOCAL* softkey or the *PRESET* key

- Notes:**
- Before the transition, command processing must be completed as otherwise transition to remote control is performed immediately.
  - The keys can be disabled by the universal command LLO (see chapter 8, section "IEC/IEEE-Bus Interface – Interface Messages) in order to prevent unintentional transition. In this case, transition to manual mode is only possible via the IEC/IEEE bus.
  - The keys can be enabled again by deactivating the *REN* line of the IEC/IEEE bus (see chapter 8, section "IEC/IEEE-Bus Interface – Bus Lines).

#### Via IEC bus:

...	
CALL IBLOC(receiver%)	'Set instrument to manual operation
...	



## Remote Control via RS-232-Interface

### Setting the Transmission Parameters

To enable an error-free and correct data transmission, the parameters of the unit and the controller should have the same setting.

Parameters can be manually changed in menu *SETUP-GENERAL SETUP* in table *COM PORT* or via remote control using the command `SYSTEM:COMMunicate:SERial:....`.

The transmission parameters of the COM interface are factory-set to the following values:

baudrate = 9600, data bits = 8, stop bits = 1, parity = NONE and owner = INSTRUMENT.

For remote control operation, the interface should be allocated to the operating system (owner = OS) so that the control characters including @ can be recognized by the interface.

- Manually:**                    Setting the COM interface
- Call *SETUP-GENERAL SETUP* menu
  - Select desired baudrate, bits, stopbit, parity in table *COM PORT*.
  - Set owner to OS in table *COM PORT*.
  - Terminate input using the *ENTER* key.

### Return to Manual Operation

Return to manual operation is possible via the front panel or via RS-232 interface.

- Manually:**                    ➤ Press the *LOCAL* softkey or the *PRESET* key.

**Notes:**

- Before the transition, command processing must be completed as otherwise transition to remote control is performed immediately
- The keys can be enabled again by sending the control string "@LOC" via RS-232 (see chapter 8, section "RS232 Interface – Control Characters").

**Via RS-232:**                    ...  
`v24puts(port, "@LOC");`    Set instrument to manual operation..  
 ...

### Limitations

The following limitations apply if the unit is remote-controlled via the RS-232-C interface:

- No interface messages, only control strings (see chapter 8, section "RS232 Interface – Control Characters").
- Only the Common Commands \*OPC? can be used for command synchronization, \*WAI and \*OPC are not available.
- Block data cannot be transmitted.

## Remote Control via Local Network (RSIB Interface)

To access the measuring instruments via the local network the instrument must be addressed with the defined IP address. The IP address of the instrument is defined in the network configuration:

### Defining the IP address:

- Open *SETUP - GENERAL SETUP* – CONFIGURE NETWORK menu.
- Select "Protocols" tab
- Define IP address for the TCP/IP protocol under "Properties" (see chapter 4, section "Option LAN Interface - FSP-B16")

## Return to Manual Operation

The return to manual operation can be performed via the front panel (*LOCAL* softkey or *PRESET* key) or the RSIB interface.

**Manually:** ➤ Press *LOCAL* softkey or *PRESET* key.

### **Note:**

*Before switchover, command processing must be completed as otherwise switchover to remote control is effected immediately.*

Via RSIB:

```
...
CALL RSDLLibloc(analyzer%, ibsta%, iberr%, ibcntl&)
                    'Switch instrument to manual control
...
```

## Messages

The messages transferred via the data lines of the IEC bus can be divided into two groups (see chapter 8, section "IEC/IEEE Bus Interface"):

- **interface messages and**
- **device messages.**

### IEC/IEEE-Bus Interface Messages

Interface messages are transferred on the data lines of the IEC bus, the "ATN" control line being active. They are used for communication between controller and instrument and can only be sent by a controller which has the IEC/IEEE bus control. Interface commands can be subdivided into

- **universal commands and**
- **addressed commands.**

Universal commands act on all devices connected to the IEC/IEEE bus without previous addressing, addressed commands only act on devices previously addressed as listeners. The interface messages relevant to the instrument are listed in chapter 8, section "IEC/IEEE-Bus Interface – Interface Functions".

### Device Messages (Commands and Device Responses)

Device messages are transferred on the data lines of the IEC bus, the "ATN" control line not being active. ASCII code is used.

A distinction is made according to the direction in which they are sent on the IEC/IEEE bus:

- **Commands** are messages the controller sends to the instrument. They operate the device functions and request information.  
The commands are subdivided according to two criteria::
  1. According to the effect they have on the instrument:
    - Setting commands** cause instrument settings such as reset of the instrument or setting the center frequency.
    - Queries** cause data to be provided for output on the IEC/IEEE bus, e.g. for identification of the device or polling the marker.
  2. According to their definition in standard IEEE 488.2:
    - Common Commands** are exactly defined as to their function and notation in standard IEEE 488.2. They refer to functions such as management of the standardized status registers, reset and selftest.
    - Device-specific commands** refer to functions depending on the features of the instrument such as frequency setting. A majority of these commands has also been standardized by the SCPI committee (cf. Section "SCPI Introduction").
- **Device responses** are messages the instrument sends to the controller after a query. They can contain measurement results, instrument settings and information on the instrument status (cf. Section "Responses to Queries").

Structure and syntax of the device messages are described in the following Section.

## Structure and Syntax of the Device Messages

### SCPI Introduction

SCPI (Standard Commands for Programmable Instruments) describes a standard command set for programming instruments, irrespective of the type of instrument or manufacturer. The goal of the SCPI consortium is to standardize the device-specific commands to a large extent. For this purpose, a model was developed which defines the same functions inside a device or for different devices. Command systems were generated which are assigned to these functions. Thus it is possible to address the same functions with identical commands. The command systems are of a hierarchical structure.

Fig. 5-1 illustrates this tree structure using a section of command system SENSE, which controls the device-specific settings, that do not refer to the signal characteristics of the measurement signal.

SCPI is based on standard IEEE 488.2, i.e. it uses the same syntactic basic elements as well as the common commands defined in this standard. Part of the syntax of the device responses is defined with greater restrictions than in standard IEEE 488.2 (see Section "Responses to Queries").

### Structure of a Command

The commands consist of a so-called header and, in most cases, one or more parameters. Header and parameter are separated by a "white space" (ASCII code 0 to 9, 11 to 32 decimal, e.g. blank). The headers may consist of several key words. Queries are formed by directly appending a question mark to the header.

**Note:** *The commands used in the following examples are not in every case implemented in the instrument.*

#### Common commands

Common commands consist of a header preceded by an asterisk "\*" and one or several parameters, if any.

Examples: \*RST        RESET, resets the device  
          \*ESE 253    EVENT STATUS ENABLE, sets the bits of  
                          the event status enable register  
          \*ESR?     EVENT STATUS QUERY, queries the  
                          contents of the event status register.

## Device-specific commands

Hierarchy: Device-specific commands are of hierarchical structure (see Fig. 5-1). The different levels are represented by combined headers. Headers of the highest level (root level) have only one key word. This key word denotes a complete command system.

Example: `SENSe` This key word denotes the command system `SENSe`.

For commands of lower levels, the complete path has to be specified, starting on the left with the highest level, the individual key words being separated by a colon ":".

Example: `SENSe:FREQuency:SPAN 10MHZ`

This command lies in the third level of the `SENSe` system. It set the frequency span.

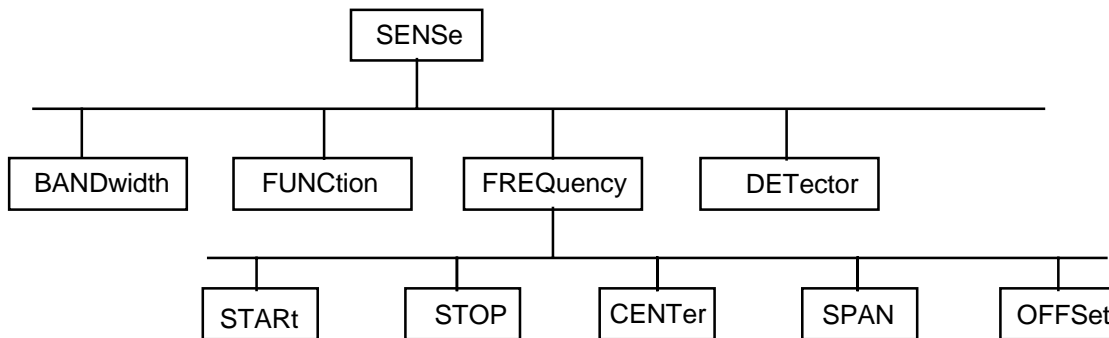

Fig. 5-1 Tree structure the SCPI command systems using the `SENSe` system by way of example

Some key words occur in several levels within one command system. Their effect depends on the structure of the command, that is to say, at which position in the header of a command they are inserted.

Example: `SOURce:FM:POLarity NORMal`

This command contains key word `POLarity` in the third command level. It defines the polarity between modulator and modulation signal.

`SOURce:FM:EXTernal:POLarity NORMal`

This command contains key word `POLarity` in the fourth command level. It defines the polarity between modulation voltage and the resulting direction of the modulation only for the external signal source indicated.

**Optional key words:** Some command systems permit certain key words to be optionally inserted into the header or omitted. These key words are marked by square brackets in the description. The full command length must be recognized by the instrument for reasons of compatibility with the SCPI standard. Some commands are considerably shortened by these optional key words.

**Example:** [SENSE]:BANDwidth[:RESolution]:AUTO

This command couples the resolution bandwidth of the instrument to other parameters. The following command has the same effect:

BANDwidth:AUTO

**Note:** *An optional key word must not be omitted if its effect is specified in detail by a numeric suffix.*

**Long and short form:** The key words feature a long form and a short form. Either the short form or the long form can be entered, other abbreviations are not permissible.

**Example:** STATus:QUESTionable:ENABle 1= STAT:QUES:ENAB 1

**Note:** *The short form is marked by upper-case letters, the long form corresponds to the complete word. Upper-case and lower-case notation only serve the above purpose, the instrument itself does not make any difference between upper-case and lower-case letters.*

**Parameter:** The parameter must be separated from the header by a "white space". If several parameters are specified in a command, they are separated by a comma ",". A few queries permit the parameters MINimum, MAXimum and DEFault to be entered. For a description of the types of parameter, refer to Section "Parameters".

**Example:** SENSE:FREQuency:STOP? MAXimum      Response: 3.5E9  
This query requests the maximal value for the stop frequency.

**Numeric suffix:** If a device features several functions or features of the same kind, e.g. inputs, the desired function can be selected by a suffix added to the command. Entries without suffix are interpreted like entries with the suffix 1.

**Example:** SYSTem:COMMunicate:SERial2:BAUD 9600

This command sets the baudrate of a second serial interface.

## Structure of a Command Line

A command line may consist of one or several commands. It is terminated by a <New Line>, a <New Line> with EOI or an EOI together with the last data byte. The IEC/IEEE driver of the controller usually produces automatically an EOI together with the last data byte.

Several commands in a command line are separated by a semicolon ";". If the next command belongs to a different command system, the semicolon is followed by a colon.

Example:

```
CALL IBWRT(receiver%, "SENSe:FREQuency:CENTer 100MHz;:INPut:ATTenuation 10")
```

This command line contains two commands. The first one is part of the SENSE command system and is used to determine the center frequency of the instrument. The second one is part of the INPUT command system and sets the input signal attenuation.

If the successive commands belong to the same system, having one or several levels in common, the command line can be abbreviated. For that purpose, the second command after the semicolon starts with the level that lies below the common levels (see also Fig. 5-1). The colon following the semicolon must be omitted in this case.

Example:

```
CALL IBWRT(receiver%, "SENSe:FREQuency:START 1E6;:SENSe:FREQuency:STOP 1E9")
```

This command line is represented in its full length and contains two commands separated from each other by the semicolon. Both commands are part of the SENSE command system, subsystem FREQUENCY, i.e. they have two common levels.

When abbreviating the command line, the second command begins with the level below SENSE:FREQUENCY. The colon after the semicolon is omitted.

The abbreviated form of the command line reads as follows:

```
CALL IBWRT(receiver%, "SENSe:FREQuency:START 1E6;STOP 1E9")
```

However, a new command line always begins with the complete path.

```
Example: CALL IBWRT(receiver, "SENSe:FREQuency:START 1E6")
        CALL IBWRT(receiver%, "SENSe:FREQuency:STOP 1E9")
```

## Responses to Queries

A query is defined for each setting command unless explicitly specified otherwise. It is formed by adding a question mark to the associated setting command. According to SCPI, the responses to queries are partly subject to stricter rules than in standard IEEE 488.2.

- 1 The requested parameter is transmitted without header.

Example:      INPut:COUpling?      Response: DC

2. Maximum values, minimum values and all further quantities, which are requested via a special text parameter are returned as numerical values.

Example:      SENSe:FREQuency:STOP? MAX      Response: 3.5E9

3. Numerical values are output without a unit. Physical quantities are referred to the basic units or to the units set using the Unit command.

Example:      SENSe:FREQuency:CENTer?      Response: 1E6 for 1 MHz

4. Truth values <Boolean values> are returned as 0 (for OFF) and 1 (for ON).

Example:      SENSe:BANDwidth:AUTO?      Response: 1 for ON

5. Text (character data) is returned in a short form (see also Section 3.5.5).

Example:      SYSTem:COMMunicate:SERial:CONTRol:RTS? Response(for standard): STAN

## Parameters

Most commands require a parameter to be specified. The parameters must be separated from the header by a "white space". Permissible parameters are numerical values, Boolean parameters, text, character strings and block data. The type of parameter required for the respective command and the permissible range of values are specified in the command description

**Numerical values** Numerical values can be entered in any form, i.e. with sign, decimal point and exponent. Values exceeding the resolution of the instrument are rounded up or down. The mantissa may comprise up to 255 characters, the exponent must lie inside the value range -32000 to 32000. The exponent is introduced by an "E" or "e". Entry of the exponent alone is not permissible. In the case of physical quantities, the unit can be entered. Permissible unit prefixes are G (giga), MA (mega), MOHM and MHZ are also permissible), K (kilo), M (milli), U (micro) and N (nano). If the unit is missing, the basic unit is used.

Example:

```
SENSe:FREQuency:STOP 1.5GHz = SENSe:FREQuency:STOP 1.5E9
```

**Special numerical** The texts MINimum, MAXimum, DEFault, UP and DOWN are interpreted as values special numerical values.

In the case of a query, the numerical value is provided.

Example: Setting command: `SENSe:FREQuency:STOP MAXimum`

Query: `SENSe:FREQuency:STOP?` Response: `3.5E9`

MIN/MAX MINimum and MAXimum denote the minimum and maximum value.

DEF DEFault denotes a preset value which has been stored in the EPROM. This value conforms to the default setting, as it is called by the \*RST command

UP/DOWN UP, DOWN increases or reduces the numerical value by one step. The step width can be specified via an allocated step command (see annex C, List of Commands) for each parameter which can be set via UP, DOWN.

INF/NINF INFINITY, Negative INFINITY (NINF) Negative INFINITY (NINF) represent the numerical values -9.9E37 or 9.9E37, respectively. INF and NINF are only sent as device responses.

NAN Not A Number (NAN) represents the value 9.91E37. NAN is only sent as device response. This value is not defined. Possible causes are the division of zero by zero, the subtraction of infinite from infinite and the representation of missing values.

**Boolean Parameters** Boolean parameters represent two states. The ON state (logically true) is represented by ON or a numerical value unequal to 0. The OFF state (logically untrue) is represented by OFF or the numerical value 0. 0 or 1 is provided in a query.

Example: Setting command: `DISPlay:WINDow:STATe ON`

Query: `DISPlay:WINDow:STATe?` Response: `1`



**Text** Text parameters observe the syntactic rules for key words, i.e. they can be entered using a short or long form. Like any parameter, they have to be separated from the header by a white space. In the case of a query, the short form of the text is provided.

Example: Setting command: INPut:COUPling GROund  
 Query: INPut:COUPling? Response GRO

**Strings** Strings must always be entered in quotation marks (' or ").

Example: SYSTem:LANGUage "SCPI" or  
 SYSTem:LANGUage 'SCPI'

**Block data** Block data are a transmission format which is suitable for the transmission of large amounts of data. A command using a block data parameter has the following structure:

Example: HEADer:HEADer #45168xxxxxxxx

ASCII character # introduces the data block. The next number indicates how many of the following digits describe the length of the data block. In the example the 4 following digits indicate the length to be 5168 bytes. The data bytes follow. During the transmission of these data bytes all End or other control signs are ignored until all bytes are transmitted.

## Overview of Syntax Elements

The following survey offers an overview of the syntax elements.

- :** The colon separates the key words of a command.  
In a command line the colon after the separating semicolon marks the uppermost command level.
- ;** The semicolon separates two commands of a command line. It does not alter the path.
- ,** The comma separates several parameters of a command.
- ?** The question mark forms a query.
- \*** The asterisk marks a common command.
- "** Quotation marks introduce a string and terminate it.
- #** The double dagger ( #) introduces block data
- A "white space (ASCII-Code 0 to 9, 11 to 32 decimal, e.g. blank) separates header and parameter.

## Instrument Model and Command Processing

The instrument model shown in Fig. 5-2 has been made viewed from the standpoint of the servicing of IEC-bus commands. The individual components work independently of each other and simultaneously. They communicate by means of so-called "messages".

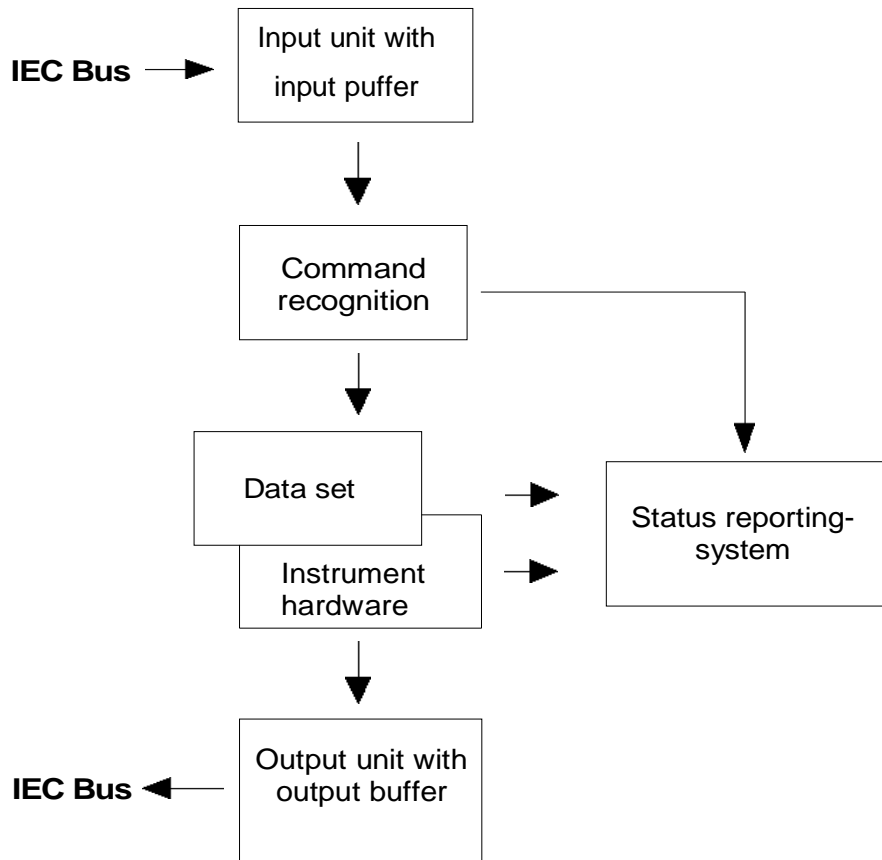

Fig. 5-2 Instrument model in the case of remote control by means of the IEC bus

### Input Unit

The input unit receives commands character by character from the IEC bus and collects them in the input buffer. The input unit sends a message to the command recognition as soon as the input buffer is full or as soon as it receives a delimiter, <PROGRAM MESSAGE TERMINATOR>, as defined in IEEE 488.2, or the interface message DCL.

If the input buffer is full, the IEC-bus traffic is stopped and the data received up to then are processed. Subsequently the IEC-bus traffic is continued. If, however, the buffer is not yet full when receiving the delimiter, the input unit can already receive the next command during command recognition and execution. The receipt of a DCL clears the input buffer and immediately initiates a message to the command recognition.

## Command Recognition

The command recognition analyses the data received from the input unit. It proceeds in the order in which it receives the data. Only a DCL is serviced with priority, a GET (Group Execute Trigger), e.g., is only executed after the commands received before as well. Each recognized command is immediately transferred to the instrument data base but without being executed there at once.

Syntactical errors in the command are recognized in the command recognition and supplied to the status reporting system. The rest of a command line after a syntax error is analyzed further if possible and serviced.

If the command recognition recognizes a delimiter (<PROGRAM MESSAGE SEPARATOR> or <PROGRAM MESSAGE TERMINATOR>) or a DCL, it requests the instrument data base to set the commands in the instrument hardware as well now. Subsequently it is immediately prepared to process commands again. This means for the command servicing that further commands can already be serviced while the hardware is still being set ("overlapping execution").

## Instrument Data Base and Instrument Hardware

Here the expression "instrument hardware" denotes the part of the instrument fulfilling the actual instrument function - signal generation, measurement etc. The controller is not included.

The instrument data base is a detailed reproduction of the instrument hardware in the software.

IEC-bus setting commands lead to an alteration in the data set. The data base management enters the new values (e.g. frequency) into the data base, however, only passes them on to the hardware when requested by the command recognition.

The data are only checked for their compatibility among each other and with the instrument hardware immediately before they are transmitted to the instrument hardware. If the detection is made that an execution is not possible, an "execution error" is signalled to the status reporting system. The alteration of the data base are cancelled, the instrument hardware is not reset.

IEC-bus queries induce the data base management to send the desired data to the output unit.

## Status Reporting System

The status reporting system collects information on the instrument state and makes it available to the output unit on request. The exact structure and function are described in Section 3.8

## Output Unit

The output unit collects the information requested by the controller, which it receives from the data base management. It processes it according to the SCPI rules and makes it available in the output buffer. If the instrument is addressed as a talker without the output buffer containing data or awaiting data from the data base management, the output unit sends error message "Query UNTERMINATED" to the status reporting system. No data are sent on the IEC bus, the controller waits until it has reached its time limit. This behavior is specified by SCPI.

## Command Sequence and Command Synchronization

What has been said above makes clear that all commands can potentially be carried out overlapping.

In order to prevent an overlapping execution of commands, one of commands \*OPC, \*OPC? or \*WAI must be used. All three commands cause a certain action only to be carried out after the hardware has been set and has settled. By a suitable programming, the controller can be forced to wait for the respective action to occur (cf. Table 5-1).

Table 5-1 Synchronization using \*OPC, \*OPC? and \*WAI

Command	Action after the hardware has settled	Programming the controller
*OPC	Setting the operation-complete bit in the ESR	- Setting bit 0 in the ESE - Setting bit 5 in the SRE - Waiting for service request (SRQ)
*OPC?	Writing a "1" into the output buffer	Addressing the instrument as a talker
*WAI	Continuing the IEC-bus handshake	Sending the next command

An example as to command synchronization can be found in Chapter "Program Examples".

For a couple of commands the synchronization to the end of command execution is mandatory in order to obtain the desired result. The affected commands require either more than one measurement in order to accomplish the desired instrument setting (eg autorange functions), or they require a longer period of time for execution. If a new command is received during execution of the corresponding function this may either lead to either to an aborted measurement or to invalid measurement data.

The following list includes the commands, for which a synchronization via \*OPC, \*OPC? or \*WAI is mandatory:

Table 5-1 Commands with mandatory synchronization (Overlapping Commands)

Command	Purpose
INIT	start measurement
INIT:CONM	continue measurement
CALC:MARK:FUNC:ZOOM	zoom frequency range around marker 1
CALC:STAT:SCAL:AUTO ONCE	optimize level settings for signal statistic measurement functions
[SENS:]POW:ACH:PRES:RLEV	optimize level settings for adjacent channel power measurements

## Status Reporting System

The status reporting system (cf. Fig. 5-4) stores all information on the present operating state of the instrument, e.g. that the instrument presently carries out a calibration and on errors which have occurred. This information is stored in the status registers and in the error queue. The status registers and the error queue can be queried via IEC bus.

The information is of a hierarchical structure. The register status byte (STB) defined in IEEE 488.2 and its associated mask register service request enable (SRE) form the uppermost level. The STB receives its information from the standard event status register (ESR) which is also defined in IEEE 488.2 with the associated mask register standard event status enable (ESE) and registers STATUS:OPERation and STATUS:QUESTionable which are defined by SCPI and contain detailed information on the instrument.

The IST flag ("Individual STATUS") and the parallel poll enable register (PPE) allocated to it are also part of the status reporting system. The IST flag, like the SRQ, combines the entire instrument status in a single bit. The PPE fulfills the same function for the IST flag as the SRE for the service request.

The output buffer contains the messages the instrument returns to the controller. It is not part of the status reporting system but determines the value of the MAV bit in the STB and thus is represented in Fig. 5-4.

### Structure of an SCPI Status Register

Each SCPI register consists of 5 parts which each have a width of 16 bits and have different functions (cf. Fig. 5-3). The individual bits are independent of each other, i.e. each hardware status is assigned a bit number which is valid for all five parts. For example, bit 3 of the STATUS:OPERation register is assigned to the hardware status "wait for trigger" in all five parts. Bit 15 (the most significant bit) is set to zero for all parts. Thus the contents of the register parts can be processed by the controller as positive integer.

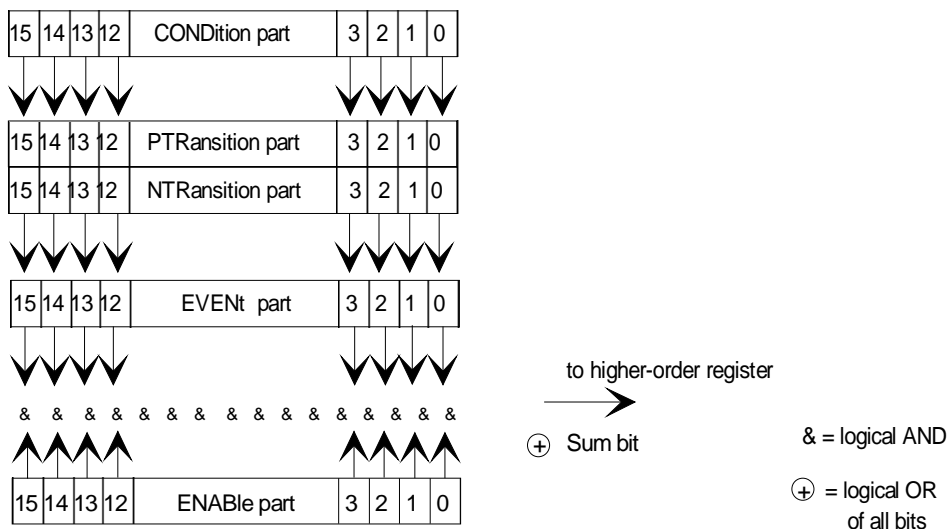

Fig. 5-3 The status-register model

<b>CONDition part</b>	The CONDition part is directly written into by the hardware or the sum bit of the next lower register. Its contents reflects the current instrument status. This register part can only be read, but not written into or cleared. Its contents is not affected by reading.
<b>PTRansition part</b>	The Positive-TRansition part acts as an edge detector. When a bit of the CONDition part is changed from 0 to 1, the associated PTR bit decides whether the EVENT bit is set to 1. PTR bit =1: the EVENT bit is set. PTR bit =0: the EVENT bit is not set. This part can be written into and read at will. Its contents is not affected by reading.
<b>NTRansition part</b>	The Negative-TRansition part also acts as an edge detector. When a bit of the CONDition part is changed from 1 to 0, the associated NTR bit decides whether the EVENT bit is set to 1. NTR-Bit = 1: the EVENT bit is set. NTR-Bit = 0: the EVENT bit is not set. This part can be written into and read at will. Its contents is not affected by reading.  With these two edge register parts the user can define which state transition of the condition part (none, 0 to 1, 1 to 0 or both) is stored in the EVENT part.
<b>EVENT part</b>	The EVENT part indicates whether an event has occurred since the last reading, it is the "memory" of the condition part. It only indicates events passed on by the edge filters. It is permanently updated by the instrument. This part can only be read by the user. During reading, its contents is set to zero. In linguistic usage this part is often equated with the entire register.
<b>ENABLE part</b>	The ENABLE part determines whether the associated EVENT bit contributes to the sum bit (cf. below). Each bit of the EVENT part is ANDed with the associated ENABLE bit (symbol '&'). The results of all logical operations of this part are passed on to the sum bit via an OR function (symbol '+'). ENABLE-Bit = 0: the associated EVENT bit does not contribute to the sum bit ENABLE-Bit = 1: if the associated EVENT bit is "1", the sum bit is set to "1" as well. This part can be written into and read by the user at will. Its contents is not affected by reading.
<b>Sum bit</b>	As indicated above, the sum bit is obtained from the EVENT and ENABLE part for each register. The result is then entered into a bit of the CONDition part of the higher-order register. The instrument automatically generates the sum bit for each register. Thus an event, e.g. a PLL that has not locked, can lead to a service request throughout all levels of the hierarchy.
<b>Note:</b>	<i>The service request enable register SRE defined in IEEE 488.2 can be taken as ENABLE part of the STB if the STB is structured according to SCPI. By analogy, the ESE can be taken as the ENABLE part of the ESR.</i>

# Overview of the Status Registers

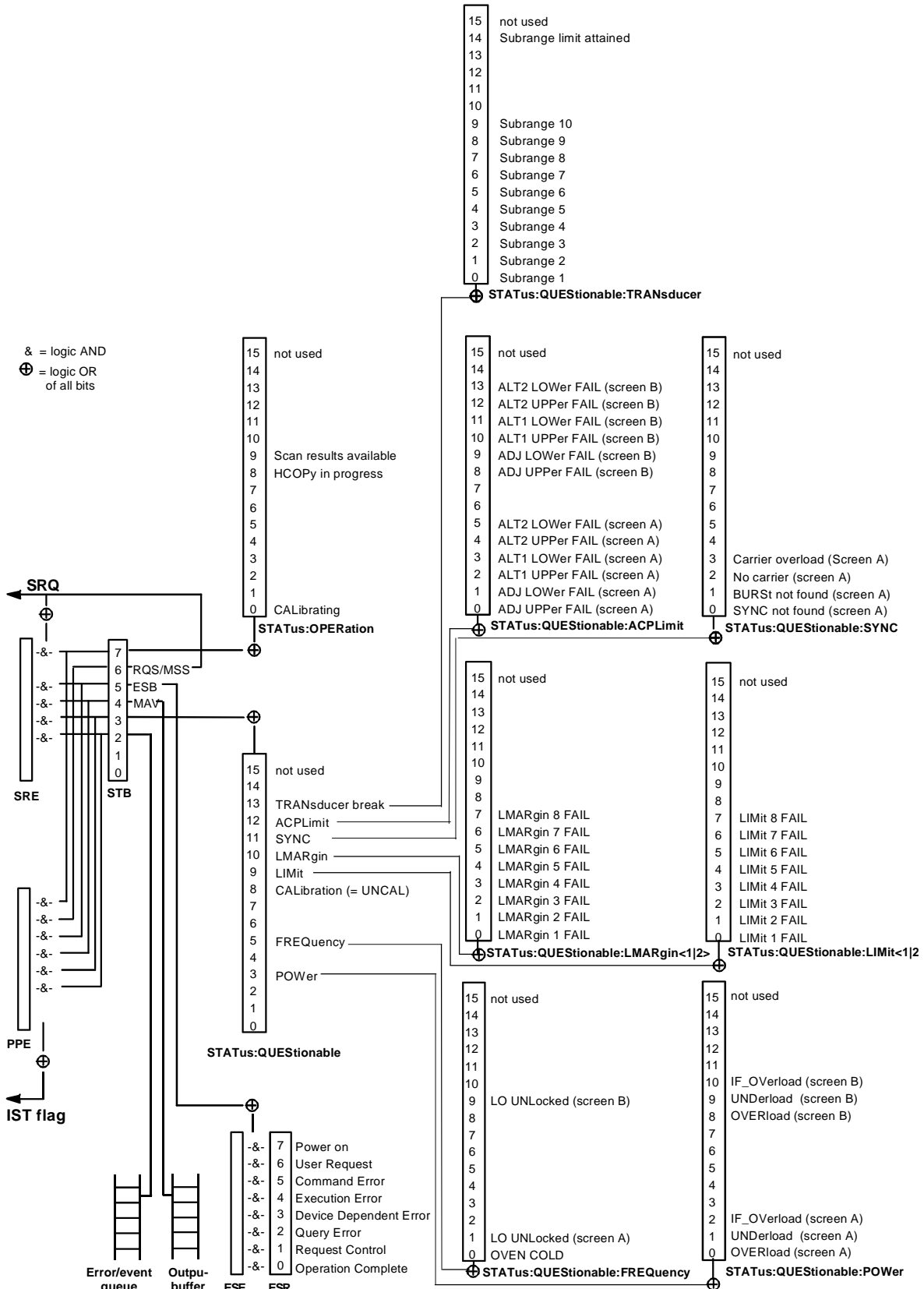

Fig. 5-4 Overview of the status registers

## Description of the Status Registers

### Status Byte (STB) and Service Request Enable Register (SRE)

The STB is already defined in IEEE 488.2. It provides a rough overview of the instrument status by collecting the pieces of information of the lower registers. It can thus be compared with the CONDition part of an SCPI register and assumes the highest level within the SCPI hierarchy. A special feature is that bit 6 acts as the sum bit of the remaining bits of the status byte.

The STATUS BYTE is read out using the command "**\*STB?**" or a serial poll.

The STB implies the SRE. It corresponds to the ENABLE part of the SCPI registers as to its function. Each bit of the STB is assigned a bit in the SRE. Bit 6 of the SRE is ignored. If a bit is set in the SRE and the associated bit in the STB changes from 0 to 1, a Service Request (SRQ) is generated on the IEC bus, which triggers an interrupt in the controller if this is appropriately configured and can be further processed there.

The SRE can be set using command "**\*SRE**" and read using "**\*SRE?**".

Table 5-2 Meaning of the bits in the status byte

Bit No.	Meaning
2	<p><b>Error Queue not empty</b></p> <p>The bit is set when an entry is made in the error queue. If this bit is enabled by the SRE, each entry of the error queue generates a Service Request. Thus an error can be recognized and specified in greater detail by polling the error queue. The poll provides an informative error message. This procedure is to be recommended since it considerably reduces the problems involved with IEC-bus control.</p>
3	<p><b>QUESTIONable status sum bit</b></p> <p>The bit is set if an EVENT bit is set in the QUESTIONable: status register and the associated ENABLE bit is set to 1. A set bit indicates a questionable instrument status, which can be specified in greater detail by polling the QUESTIONable status register.</p>
4	<p><b>MAV bit</b> (message available)</p> <p>The bit is set if a message is available in the output buffer which can be read. This bit can be used to enable data to be automatically read from the instrument to the controller (cf. Chapter 7, program examples).</p>
5	<p><b>ESB bit</b></p> <p>Sum bit of the event status register. It is set if one of the bits in the event status register is set and enabled in the event status enable register. Setting of this bit implies an error or an event which can be specified in greater detail by polling the event status register.</p>
6	<p><b>MSS bit</b> (master status summary bit)</p> <p>The bit is set if the instrument triggers a service request. This is the case if one of the other bits of this registers is set together with its mask bit in the service request enable register SRE.</p>
7	<p><b>OPERation status register sum bit</b></p> <p>The bit is set if an EVENT bit is set in the OPERation-Status register and the associated ENABLE bit is set to 1. A set bit indicates that the instrument is just performing an action. The type of action can be determined by polling the OPERation-status register.</p>



### IST Flag and Parallel Poll Enable Register (PPE)

By analogy with the SRQ, the IST flag combines the entire status information in a single bit. It can be queried by means of a parallel poll (cf. Section 3.8.4.3) or using command `"*IST?"`.

The parallel poll enable register (PPE) determines which bits of the STB contribute to the IST flag. The bits of the STB are ANDed with the corresponding bits of the PPE, with bit 6 being used as well in contrast to the SRE. The Ist flag results from the ORing of all results. The PPE can be set using commands `"*PRE"` and read using command `"*PRE?"`.

### Event-Status Register (ESR) and Event-Status-Enable Register (ESE)

The ESR is already defined in IEEE 488.2. It can be compared with the EVENT part of an SCPI register. The event status register can be read out using command `"*ESR?"`.

The ESE is the associated ENABLE part. It can be set using command `"*ESE"` and read using command `"*ESE?"`.

Table 5-3 Meaning of the bits in the event status register

Bit No.	Meaning
0	<b>Operation Complete</b> This bit is set on receipt of the command <code>*OPC</code> exactly when all previous commands have been executed.
1	This bit is not used
2	<b>Query Error</b> This bit is set if either the controller wants to read data from the instrument without having send a query, or if it does not fetch requested data and sends new instructions to the instrument instead. The cause is often a query which is faulty and hence cannot be executed.
3	<b>Device-dependent Error</b> This bit is set if a device-dependent error occurs. An error message with a number between -300 and -399 or a positive error number, which denotes the error in greater detail, is entered into the error queue (cf. Chapter 9, Error Messages).
4	<b>Execution Error</b> This bit is set if a received command is syntactically correct, however, cannot be performed for other reasons. An error message with a number between -200 and -300, which denotes the error in greater detail, is entered into the error queue (cf. Chapter 9, Error Messages).
5	<b>Command Error</b> This bit is set if a command which is undefined or syntactically incorrect is received. An error message with a number between -100 and -200, which denotes the error in greater detail, is entered into the error queue (cf. Chapter 9 "Error Messages").
6	<b>User Request</b> This bit is set on pressing the <i>LOCAL</i> key.
7	<b>Power On</b> (supply voltage on) This bit is set on switching on the instrument.

## STATus:OPERation Register

In the CONDition part, this register contains information on which actions the instrument is being executing or, in the EVENt part, information on which actions the instrument has executed since the last reading. It can be read using commands "STATus:OPERation:CONDition?" or "STATus:OPERation[:EVENT]?".

Table 5-4 Meaning of the bits in the STATus.OPERation register

Bit No.	Meaning
0	<b>CALibrating</b> This bit is set as long as the instrument is performing a calibration.
1 to 7	These bits are not used
8	<b>HardCOPy in progress</b> This bit is set while the instrument is printing a hardcopy.
8	<b>Scan results available</b> This bit is set as soon as a data block is ready for output during a scan.
10 to 14	These bits are not used
15	This bit is always 0

## STATus:QUESTionable Register

This register comprises information about indefinite states which may occur if the unit is operated without meeting the specifications. It can be queried by commands `STATus:QUESTionable:CONDition?` and `STATus:QUESTionable[:EVENT]?`.

Table 5-5 Meaning of bits in STATus:QUESTionable register

Bit No.	Meaning
0 to 2	These bits are not used
3	<b>POWER</b> This bit is set if a questionable power occurs (cf. also section "STATus:QUESTionable:POWER Register")
4	<b>TEMPerature</b> This bit is set if a questionable temperature occurs.
5	<b>FREQuency</b> The bit is set if a frequency is questionable (cf. section "STATus:QUESTionable:FREQuency Register")
6 to 7	These bits are not used
8	<b>CALibration</b> The bit is set if a measurement is performed uncalibrated (=, ^ label "UNCAL")
9	<b>LIMit</b> (device-specific) This bit is set if a limit value is violated (see also section STATus:QUESTionable:LIMit Register)
10	<b>LMARgin</b> (device-specific) This bit is set if a margin is violated (see also section STATus:QUESTionable:LMARgin Register)
11	<b>SYNC</b> (device-dependent) This bit is set if, in measurements or premeasurements in GSM MS mode, synchronization to midamble fails or no burst is found. This bit is also set if, in premeasurements in GSM MS mode, the result differs too strongly from the expected value (see also "STATus:QUESTionable:SYNC Register").
12	<b>ACPLimit</b> (device-specific) This bit is set if a limit for the adjacent channel power measurement is violated (see also section "STATus:QUESTionable:ACPLimit Register")
13	<b>TRANsducer break</b> This bit is set when the limit of the transducer set subrange is attained.
14	This bit is not used
15	This bit is always 0.

## STATus QUESTIONable:ACPLimit Register

This register comprises information about the observance of limits during adjacent power measurements. It can be queried with commands 'STATus:QUESTIONable:ACPLimit:CONDition?' and 'STATus:QUESTIONable:ACPLimit[:EVENT]?'

Table 5-6 Meaning of bits in STATus:QUESTIONable:ACPLimit register

Bit No.	Meaning
0	<b>ADJ UPPER FAIL(Screen A)</b> This bit is set if in screen A. the limit is exceeded in the upper adjacent channel
1	<b>ADJ LOWER FAIL (Screen A)</b> This bit is set if in screen A the limit is exceeded in the lower adjacent channel.
2	<b>ALT1 UPPER FAIL (Screen A)</b> This bit is set if in screen A the limit is exceeded in the upper 1st alternate channel.
3	<b>ALT1 LOWER FAIL (Screen A)</b> This bit is set if in screen A the limit is exceeded in the lower 1st alternate channel.
4	<b>ALT2 UPPER FAIL (Screen A)</b> This bit is set if in screen A the limit is exceeded in the upper 2nd alternate channel.
5	<b>ALT2 LOWER FAIL (Screen A)</b> This bit is set if in screen A the limit is exceeded in the lower 2nd alternate channel.
6 to 7	not used
8	<b>ADJ UPPER FAIL (Screen B)</b> This bit is set if in screen B the limit is exceeded in the upper adjacent channel.
9	<b>ADJ LOWER FAIL (Screen B)</b> This bit is set if in screen B the limit is exceeded in the lower adjacent channel.
10	<b>ALT1 UPPER FAIL (Screen B)</b> This bit is set if in screen B the limit is exceeded in the upper 1st alternate channel.
11	<b>ALT1 LOWER FAIL (Screen B)</b> This bit is set if in screen B the limit is exceeded in the lower 1st alternate channel.
12	<b>ALT2 UPPER FAIL (Screen B)</b> This bit is set if in screen B the limit is exceeded in the upper 2nd alternate channel.
13	<b>ALT2 LOWER FAIL (Screen B)</b> This bit is set if in screen B the limit is exceeded in the lower 2nd alternate channel.
14	not used
15	This bit is always set to 0.

**STATUS QUESTIONABLE:FREQUENCY Register**

This register comprises information about the reference and local oscillator. It can be queried with commands `STATUS:QUESTIONABLE:FREQUENCY:CONDITION?` and `STATUS:QUESTIONABLE:FREQUENCY[:EVENT]?`.

Table 5-7 Meaning of bits in STATUS:QUESTIONABLE:FREQUENCY register

Bit No.	Meaning
0	<b>OVEN COLD</b> This bit is set if the reference oscillator has not yet attained its operating temperature. 'OCXO' will then be displayed.
1	<b>LO UNLocked</b> (Screen A) This bit is set if the local oscillator no longer locks. 'LOUNL' will then be displayed.
2 to 8	not used
9	<b>LO UNLocked</b> (Screen B) This bit is set if the local oscillator no longer locks.' LOUNL' will then be displayed.
10 to 14	not used
15	This bit is always 0.

**STATUS QUESTIONABLE:LIMit<1|2> Register**

This register comprises information about the observance of limit lines in the corresponding measurement window (LIMit 1 corresponds to Screen A, LIMit 2 to Screen B). It can be queried with commands `STATUS:QUESTIONABLE:LIMit<1|2>:CONDITION?` and `STATUS:QUESTIONABLE:LIMit<1|2>[:EVENT]?`.

Table 5-8 Meaning of bits in STATUS:QUESTIONABLE:LIMit&lt;1|2&gt; register

Bit No.	Meaning
0	<b>LIMit 1 FAIL</b> This bit is set if limit line 1 is violated.
1	<b>LIMit 2 FAIL</b> This bit is set if limit line 2 is violated.
2	<b>LIMit 3 FAIL</b> This bit is set if limit line 3 is violated.
3	<b>LIMit 4 FAIL</b> This bit is set if limit line 4 is violated.
4	<b>LIMit 5 FAIL</b> This bit is set if limit line 5 is violated.
5	<b>LIMit 6 FAIL</b> This bit is set if limit line 6 is violated.
6	<b>LIMit 7 FAIL</b> This bit is set if limit line 7 is violated.
7	<b>LIMit 8 FAIL</b> This bit is set if limit line 8 is violated.
8 to 14	not used
15	This bit is always 0.

### STATUS QUESTIONABLE:LMARGIN<1|2> Register

This register comprises information about the observance of limit margins in the corresponding measurement window (LMARGIN1 corresponds to Screen A, LMARGIN2 corresponds to Screen B). It can be queried with commands STATUS:QUESTIONABLE:LMARGIN<1|2>:CONDITION? and "STATUS :QUESTIONABLE:LMARGIN<1|2>[:EVENT]?".

Table 5-9 Meaning of bits in STATUS:QUESTIONABLE:LMARGIN<1|2> register

Bit No.	Meaning
0	<b>LMARGIN 1 FAIL</b> This bit is set if limit margin 1 is violated.
1	<b>LMARGIN 2 FAIL</b> This bit is set if limit margin 2 is violated.
2	<b>LMARGIN 3 FAIL</b> This bit is set if limit margin 3 is violated.
3	<b>LMARGIN 4 FAIL</b> This bit is set if limit margin 4 is violated.
4	<b>LMARGIN 5 FAIL</b> This bit is set if limit margin 5 is violated.
5	<b>LMARGIN 6 FAIL</b> This bit is set if limit margin 1 is violated.
6	<b>LMARGIN 7 FAIL</b> This bit is set if limit margin 7 is violated.
7	<b>LMARGIN 8 FAIL</b> This bit is set if limit margin 8 is violated.
8 to 14	not used
15	This bit is always 0.

## STATus QUEStionable:POWer Register

This register comprises all information about possible overloads of the unit.

It can be queried with commands `STATus:QUEStionable:POWer:CONDition?` and `"STATus:QUEStionable:POWer[:EVENT]?"`.

Table 5-10 Meaning of bits in STATus:QUEStionable:POWer register

Bit No.	Meaning
0	<b>OVERload</b> (Screen A) This bit is set if the RF input is overloaded. 'OVLD' will then be displayed.
1	<b>UNDerload</b> (Screen A) This bit is set if the RF input is underloaded. 'UNLD' will then be displayed.
2	<b>IF_OVERload</b> (Screen A) This bit is set if the IF path is overloaded. 'IFOVL' will then be displayed.
3 to 7	not used
8	<b>OVERload</b> (Screen B) This bit is set if the RF input is overloaded. 'OVLD' will then be displayed.
9	<b>UNDerload</b> (Screen B) This bit is set if the RF input is underloaded. 'UNLD' will then be displayed.
10	<b>IF_OVERload</b> (Screen B) This bit is set if the IF path is overloaded. 'IFOVL' will then be displayed.
11 to 14	not used
15	This bit is always 0.



**STATus-QUEStionable:SYNC Register**

This register is used only with GSM MS mode. It contains information about sync and bursts not found, and about premeasurement results exceeding or falling short of expected values.

The bits can be queried with commands "STATus:QUEStionable:SYNC:CONDition?" and "STATus:QUEStionable:SYNC[:EVENT]?".

Table 5-11 Meaning of bits in STATus:QUEStionable:SYNC register

Bit No.	Meaning
0	<p><b>BURSt not found (screen A)</b></p> <p>This bit is set if no burst is found in the measurements/premeasurements for phase/frequency error (PFE) or carrier power versus time (PVT) in GSM MS mode. If a burst is found in these measurements/premeasurements, the bit is reset.</p>
1	<p><b>SYNC not found (screen A)</b></p> <p>This bit is set if the synchronization sequence (training sequence) of the midamble is not found in the measurements/premeasurements for phase/frequency error (PFE) or carrier power versus time (PVT) in GSM MS mode. If the synchronization sequence (training sequence) of the midamble is found in these measurements/premeasurements, the bit is reset.</p>
2	<p><b>No carrier (screen A)</b></p> <p>This bit is set if, in GSM MS mode, the level value determined in the premeasurements for carrier power versus time (PVT) and spectrum due to modulation is too low. The bit is reset at the beginning of the premeasurement (see also Chapter 2, description of the named premeasurements).</p>
3	<p><b>Carrier overload (screen A)</b></p> <p>This bit is set if, in GSM MS mode, the level value determined in the premeasurements for carrier versus time (PVT) and spectrum due to modulation is too high. The bit is reset at the beginning of the premeasurement (see also Chapter 2, description of the named premeasurements).</p>
4-14	Not used.
15	This bit is always 0.

## STATus QUEStionable:TRANsducer Register

This register indicates that a transducer hold point is attained (bit 15) and what range is to be swept next (bit 0 to 10). The sweep can be continued with command `INITiate2:CONMeasure`.

It can be queried with commands `'STATus:QUEStionable:TRANsducer:CONDition?'` and `'STATus :QUEStionable:TRANsducer[:EVENT]?'`.

Table 5-12 Meaning of bits in STATus:QUEStionable:TRANsducer register

Bit No.	Meaning
0	<b>Range 1</b> This bit is set when subrange 1 is attained.
1	<b>Range 2</b> This bit is set when subrange 2 is attained.
2	<b>Range 3</b> This bit is set when subrange 3 is attained.
3	<b>Range 4</b> This bit is set when subrange 4 is attained.
4	<b>Range 5</b> This bit is set when subrange 1 is attained.
5	<b>Range 6</b> This bit is set when subrange 6 is attained.
6	<b>Range 7</b> This bit is set when subrange 7 is attained.
7	<b>Range 8</b> This bit is set when subrange 8 is attained.
8	<b>Range 9</b> This bit is set when subrange 9 is attained.
9	<b>Range 10</b> This bit is set when subrange 10 is attained.
10	<b>not used</b>
11	<b>not used</b>
12	<b>not used</b>
13	<b>not used</b>
14	<b>Subrange limit</b> This bit is set when the transducer is at the point of changeover from one range to another.
15	This bit is always 0.

## Application of the Status Reporting Systems

In order to be able to effectively use the status reporting system, the information contained there must be transmitted to the controller and further processed there. There are several methods which are represented in the following. Detailed program examples are to be found in chapter 7, Program Examples.

### Service Request, Making Use of the Hierarchy Structure

Under certain circumstances, the instrument can send a service request (SRQ) to the controller. Usually this service request initiates an interrupt at the controller, to which the control program can react with corresponding actions. As evident from Fig. 5-4, an SRQ is always initiated if one or several of bits 2, 3, 4, 5 or 7 of the status byte are set and enabled in the SRE. Each of these bits combines the information of a further register, the error queue or the output buffer. The corresponding setting of the ENABLE parts of the status registers can achieve that arbitrary bits in an arbitrary status register initiate an SRQ. In order to make use of the possibilities of the service request, all bits should be set to "1" in enable registers SRE and ESE.

Examples (cf. Fig. 5-3 and chapter 7, Program Examples, as well):

Use of command "\*OPC" to generate an SRQ at the end of a sweep.

- CALL IBWRT(receiver%, "\*ESE 1") Set bit 0 in the ESE (Operation Complete)
- CALL IBWRT(receiver%, "\*SRE 32") Set bit 5 in the SRE (ESB)?

After its settings have been completed, the instrument generates an SRQ.

The SRQ is the only possibility for the instrument to become active on its own. Each controller program should set the instrument in a way that a service request is initiated in the case of malfunction. The program should react appropriately to the service request. A detailed example for a service request routine is to be found in chapter 7, Program Examples.

### Serial Poll

In a serial poll, just as with command "\*STB", the status byte of an instrument is queried. However, the query is realized via interface messages and is thus clearly faster. The serial-poll method has already been defined in IEEE 488.1 and used to be the only standard possibility for different instruments to poll the status byte. The method also works with instruments which do not adhere to SCPI or IEEE 488.2.

The VISUAL BASIC command for executing a serial poll is "IBRSP()". Serial poll is mainly used to obtain a fast overview of the state of several instruments connected to the IEC bus.

## Parallel Poll

In a parallel poll, up to eight instruments are simultaneously requested by the controller by means of a single command to transmit 1 bit of information each on the data lines, i.e., to set the data line allocated to each instrument to logically "0" or "1". By analogy to the SRE register which determines under which conditions an SRQ is generated, there is a parallel poll enable register (PPE) which is ANDed with the STB bit by bit as well considering bit 6. The results are ORed, the result is then sent (possibly inverted) as a response in the parallel poll of the controller. The result can also be queried without parallel poll by means of command "\*IST".

The instrument first has to be set for the parallel poll using quick-BASIC command "IBPPC()". This command allocates a data line to the instrument and determines whether the response is to be inverted. The parallel poll itself is executed using "IBRPP()".

The parallel-poll method is mainly used in order to quickly find out after an SRQ which instrument has sent the service request if there are many instruments connected to the IEC bus. To this effect, SRE and PPE must be set to the same value. A detailed example as to the parallel poll is to be found in chapter 7, Program Examples.

## Query by Means of Commands

Each part of every status register can be read by means of queries. The individual commands are indicated in the detailed description of the registers in Section 3.8.3. What is returned is always a number which represents the bit pattern of the register queried. Evaluating this number is effected by the controller program.

Queries are usually used after an SRQ in order to obtain more detailed information on the cause of the SRQ.

## Error-Queue Query

Each error state in the instrument leads to an entry in the error queue. The entries of the error queue are detailed plain-text error messages which can be looked at in the ERROR menu via manual control or queried via the IEC bus using command "SYSTem:ERRor?". Each call of "SYSTem:ERRor?" provides an entry from the error queue. If no error messages are stored there any more, the instrument responds with 0, "No error".

The error queue should be queried after every SRQ in the controller program as the entries describe the cause of an error more precisely than the status registers. Especially in the test phase of a controller program the error queue should be queried regularly since faulty commands from the controller to the instrument are recorded there as well.

## Resetting Values of the Status Reporting System

Table 5-13 comprises the different commands and events causing the status reporting system to be reset. None of the commands, except for \*RST and SYSTem:PRESet influences the functional instrument settings. In particular, DCL does not change the instrument settings.

Table 5-13 Resetting instrument functions

Event	Switching on supply voltage		DCL,SDC  (Device Clear, Selected Device Clear)	*RST or SYSTem:PRESet	STATus:PRESet	*CLS
	Power-On-Status-Clear					
	0	1				
Clear STB,ESR	—	yes	—	—	—	yes
Clear SRE,ESE	—	yes	—	—	—	—
Clear PPE	—	yes	—	—	—	—
Clear EVENTt parts of the registers	—	yes	—	—	—	yes
Clear Enable parts of all OPERation and QUEStionable registers, Fill Enable parts of all other registers with "1".	—	yes	—	—	yes	—
Fill PTRansition parts with "1", Clear NTRansition parts	—	yes	—	—	yes	—
Clear error queue	yes	yes	—	—	—	yes
Clear output buffer	yes	yes	yes	1)	1)	1)
Clear command processing and input buffer	yes	yes	yes	—	—	—

1) Every command being the first in a command line, i.e., immediately following a <PROGRAM MESSAGE TERMINATOR> clears the output buffer.

# Contents - Chapter 6

## "Remote Control - Description of Commands"

<b>6 Remote Control - Description of Commands</b> .....	<b>6.1</b>
<b>Notation</b> .....	<b>6.1</b>
<b>Common Commands</b> .....	<b>6.4</b>
<b>ABORt Subsystem</b> .....	<b>6.7</b>
<b>CALCulate Subsystem</b> .....	<b>6.7</b>
CALCulate:DELTamarker Subsystem .....	6.8
CALCulate:LIMit Subsystem .....	6.16
CALCulate:LIMit:ACPowEr Subsystem .....	6.20
CALCulate:LIMit:CONTRol Subsystem .....	6.31
CALCulate:LIMit:LOWer Subsystem .....	6.33
CALCulate:LIMit:UPPer Subsystem .....	6.36
CALCulate:MARKer Subsystem .....	6.39
CALCulate:MARKer:FUNCTion Subsystem .....	6.47
CALCulate:MARKer:FUNCTion:POWer Subsystem .....	6.54
CALCulate:MARKer:FUNCTion:STRack Subsystem .....	6.59
CALCulate:MARKer:FUNCTion:SUMMery Subsystem .....	6.61
CALCulate:MATH Subsystem .....	6.73
CALCulate:PEAKsearch - Subsystem .....	6.75
CALCulate:STATistics Subsystem .....	6.76
CALCulate:THReshold Subsystem .....	6.80
CALCulate:UNIT Subsystem .....	6.82
<b>CALibration Subsystem</b> .....	<b>6.83</b>
<b>DIAGnostic Subsystem</b> .....	<b>6.85</b>
<b>DISPlay Subsystem</b> .....	<b>6.87</b>
<b>FORMat Subsystem</b> .....	<b>6.95</b>
<b>HCOPy Subsystem</b> .....	<b>6.96</b>
<b>INITiate Subsystem</b> .....	<b>6.101</b>
<b>INPut Subsystem</b> .....	<b>6.103</b>
<b>INSTrument Subsystem</b> .....	<b>6.107</b>
<b>MMEMory Subsystem</b> .....	<b>6.108</b>
<b>OUTPut Subsystem</b> .....	<b>6.121</b>
<b>SENSE Subsystem</b> .....	<b>6.122</b>
SENSE:AVERage Subsystem .....	6.122
SENSE:BANDwidth Subsystem .....	6.124
SENSE:CORREction Subsystem .....	6.127
SENSE:DEMod Subsystem .....	6.132
SENSE:DETEctor Subsystem .....	6.133
SENSE:FREQUency Subsystem.....	6.135
SENSE:LIST Subsystem.....	6.138
SENSE:MPOWer – Subsystem .....	6.144

SENSe:POWer Subsystem ..... 6.148

SENSe:ROSCillator Subsystem ..... 6.153

SENSe:SCAN - Subsystem ..... 6.154

SENSe:SWEEp Subsystem ..... 6.157

SENSe:TV - Subsystem ..... 6.161

**SOURce Subsystem ..... 6.162**

    Internal Tracking Generator..... 6.162

    SOURce:EXTernal Subsystem..... 6.165

**STATus Subsystem ..... 6.169**

**SYSTem Subsystem ..... 6.180**

**TRACe Subsystem ..... 6.191**

    General Trace Commands ..... 6.191

    TRACe:IQ-Subsystem ..... 6.194

**TRIGger Subsystem..... 6.202**

**UNIT Subsystem ..... 6.205**

**Alphabetical List of Commands ..... 6.206**

**Table of Softkeys and Hotkeys with IEC/IEEE Bus Command Assignment..... 6.217**

    Receiver Mode..... 6.217

        FREQUENCY Key ..... 6.219

        SPAN Key ..... 6.219

        AMPT Key ..... 6.220

        MKR Key ..... 6.221

        MKR-> Key ..... 6.222

        MKR FCTN Key..... 6.223

        BW Key ..... 6.224

        SWEEP Key ..... 6.225

        MEAS Key ..... 6.226

        TRIG Key..... 6.228

        TRACE Key ..... 6.229

    Signal Analyzer Mode ..... 6.230

        FREQUENCY Key ..... 6.230

        SPAN Key ..... 6.231

        AMPT Key ..... 6.232

        MKR Key ..... 6.233

        MKR-> Key ..... 6.234

        MKR FCTN Key..... 6.235

        BW Key ..... 6.236

        SWEEP Key ..... 6.237

        MEAS Key ..... 6.238

        TRIG Key..... 6.241

        TRACE Key ..... 6.242

    General Settings ..... 6.244

        LINES Key ..... 6.244

        DISP Key ..... 6.246

        FILE Key ..... 6.247

        CAL Key ..... 6.248

        SETUP Key ..... 6.249

        HCOPY Key..... 6.252

    Hotkeys..... 6.253

## 6 Remote Control - Description of Commands

### Notation

In the following sections, all commands implemented in the instrument are first listed in tables and then described in detail, arranged according to the command subsystems. The notation is adapted to the SCPI standard. The SCPI conformity information is included in the individual description of the commands.

#### Table of Commands

- Command: In the command column, the table provides an overview of the commands and their hierarchical arrangement (see indentations).
- Parameter: The parameter column indicates the requested parameters together with their specified range.
- Unit: The unit column indicates the basic unit of the physical parameters.
- Comment: In the comment column an indication is made on:
  - whether the command does not have a query form,
  - whether the command has only one query form
  - whether the command is implemented only with a certain option of the instrument

#### Indentations

The different levels of the SCPI command hierarchy are represented in the table by means of indentations to the right. The lower the level, the further the indentation to the right. Please note that the complete notation of the command always includes the higher levels as well.

Example: `SENSe:FREQuency:CENTer` is represented in the table as follows:

SENSe	first level
:FREQuency	second level
:CENTer	third level

**Individual description** The individual description contains the complete notation of the command. An example for each command, the \*RST value and the SCPI information are included as well.

The operating modes for which a command can be used are indicated by the following abbreviations:

- R Receiver
- A Spectrum analysis
- A-F Spectrum analysis - frequency domain only
- A-T Spectrum analysis - time domain only (zero span)

**Note:** *The receiver and spectrum analysis modes are implemented in the basic unit. For the other modes, the corresponding options are required.*



**Upper/lower case notation** Upper/lower case letters are used to mark the long or short form of the key words of a command in the description (see Chapter 5). The instrument itself does not distinguish between upper and lower case letters.

**Special characters |** A selection of key words with an identical effect exists for several commands. These keywords are indicated in the same line; they are separated by a vertical stroke. Only one of these keywords needs to be included in the header of the command. The effect of the command is independent of which of the keywords is used.

Example: `SENSe:FREQuency:CW|:FIXed`

The two following commands with identical meaning can be created. They set the frequency of the fixed frequency signal to 1 kHz:

`SENSe:FREQuency:CW 1E3 = SENSe:FREQuency:FIXed 1E3`

A vertical stroke in parameter indications marks alternative possibilities in the sense of "or". The effect of the command is different, depending on which parameter is used.

Example: Selection of the parameters for the command

`DISPlay:FORMat FULL | SPLit`

If parameter FULL is selected, full screen is displayed, in the case of SPLit, split screen is displayed.

**[ ]** Key words in square brackets can be omitted when composing the header (cf. Chapter 5, Optional Keywords). The full command length must be accepted by the instrument for reasons of compatibility with the SCPI standards.

Parameters in square brackets can be incorporated optionally in the command or omitted as well.

**{ }** Parameters in braces can be incorporated optionally in the command, either not at all, once or several times.

**Description of parameters** Due to the standardization, the parameter section of SCPI commands consists always of the same syntactical elements. SCPI has therefore specified a series of definitions, which are used in the tables of commands. In the tables, these established definitions are indicated in angled brackets (<...>) and will be briefly explained in the following (see also Chapter 5, Section "Parameters").

<Boolean> This keyword refers to parameters which can adopt two states, "on" and "off". The "off" state may either be indicated by the keyword **OFF** or by the numeric value 0, the "on" state is indicated by **ON** or any numeric value other than zero. Parameter queries are always returned the numeric value 0 or 1.

<numeric\_value>  
<num>

These keywords mark parameters which may be entered as numeric values or be set using specific keywords (character data).

The following keywords given below are permitted:

MINimum This keyword sets the parameter to the smallest possible value.

MAXimum This keyword sets the parameter to the largest possible value.

DEFault This keyword is used to reset the parameter to its default value.

UP This keyword increments the parameter value.

DOWN This keyword decrements the parameter value.

The numeric values associated to MAXimum/MINimum/DEFault can be queried by adding the corresponding keywords to the command. They must be entered following the quotation mark.

Example:SENSE:FREQUENCY:CENTer? MAXimum

returns the maximum possible numeric value of the center frequency as result.

<arbitrary block program data>

This keyword is provided for commands the parameters of which consist of a binary data block.

## Common Commands

The common commands are taken from the IEEE 488.2 (IEC 625-2) standard. A particular command has the same effect on different devices. The headers of these commands consist of an asterisk "\*" followed by three letters. Many common commands refer to the status reporting system which is described in detail in Chapter 5.

Command	Parameter	Function	Comment
*CAL?		Calibration Query	query only
*CLS		Clear Status	no query
*ESE	0 to 255	Event Status Enable	
*ESR?		Standard Event Status Query	query only
*IDN?		Identification Query	query only
*IST?		Individual Status Query	query only
*OPC		Operation Complete	
*OPT?		Option Identification Query	query only
*PCB	0 to 30	Pass Control Back	no query
*PRE	0 to 255	Parallel Poll Register Enable	
*PSC	0   1	Power On Status Clear	
*RST		Reset	no query
*SRE	0 to 255	Service Request Enable	
*STB?		Status Byte Query	query only
*TRG		Trigger	no query
*TST?		Self Test Query	query only
*WAI		Wait to continue	no query



**\*PCB 0 to 30**

**PASS CONTROL BACK** indicates the controller address which the IEC-bus control is to be returned to after termination of the triggered action.

**\*PRE 0 to 255**

**PARALLEL POLL REGISTER ENABLE** sets the parallel poll enable register to the indicated value. The query form *\*PRE?* returns the contents of the parallel poll enable register in decimal form.

**\*PSC 0 | 1**

**POWER ON STATUS CLEAR** determines whether the contents of the ENABLE registers are preserved or reset during power-up.

*\*PSC = 0* causes the contents of the status registers to be preserved. Thus a service request can be generated when switching on the instrument, if the status registers ESE and SRE are suitably configured.

*\*PSC ≠ 0* Resets the registers.

The query form *\*PSC?* reads out the contents of the power-on-status-clear flag. The response can be 0 or 1.

**\*RST**

**RESET** sets the instrument to a defined default status. The command essentially corresponds to pressing the *PRESET* key. The default setting is indicated in the description of the commands.

**\*SRE 0 to 255**

**SERVICE REQUEST ENABLE** sets the service request enable register to the indicated value. Bit 6 (MSS mask bit) remains 0. This command determines under which conditions a service request is generated. The query form *\*SRE?* reads the contents of the service request enable register in decimal form. Bit 6 is always 0.

**\*STB?**

**READ STATUS BYTE QUERY** reads out the contents of the status byte in decimal form.

**\*TRG**

**TRIGGER** initiates all actions in the currently active test screen expecting a trigger event. This command corresponds to *INITiate:IMMediate* (cf. Section "TRIGger Subsystem").

**\*TST?**

**SELF TEST QUERY** initiates the selftest of the instrument and outputs an error code in decimal form (0 = no error).

**\*WAI**

**WAIT-to-CONTINUE** permits servicing of subsequent commands only after all preceding commands have been executed and all signals have settled (cf. Chapter 5 and "*\*OPC*" as well).

## ABORt Subsystem

The ABORt subsystem contains the commands for aborting triggered actions. An action can be triggered again immediately after being aborted. All commands trigger events, and therefore they have no \*RST value.

COMMAND	PARAMETERS	UNIT	COMMENT
:ABORt	--	--	no query
:HOLD	--	--	

### ABORt

This command aborts a current measurement and resets the trigger system.

**Example:** "ABOR; INIT: IMM"

**Characteristics:** \*RST value: 0  
SCPI: conforming

**Mode:** R, A

### HOLD

This command interrupts a current scan measurement.

**Example:** "HOLD" ' interrupts the current scan measurement

**Features:** \*RST value: -  
SCPI: conforming

**Mode:** R

## CALCulate Subsystem

The CALCulate subsystem contains commands for converting instrument data, transforming and carrying out corrections. These functions are carried out subsequent to data acquisition, ie following the SENSE subsystem.

The numeric suffix is used in CALCulate to make the distinction between the two measurement windows SCREEN A and SCREEN B:

CALCulate1 = Screen A

CALCulate2 = Screen B.

For commands without suffix, screen A is selected automatically.

**Full Screen** The settings are valid for the measurement window selected with the numeric suffix. They become effective as soon as the corresponding measurement window has been selected as active measurement window using the command `DISPLay[:WINDow<1|2>]:SElect`. Triggering measurements and querying measured values is possible only in the active measurement window.

**Split Screen** The settings are valid for the measurement window selected by means of the numeric suffix and become effective immediately.

**Note:** *In receiver mode, the markers can only be activated for the scan display. Therefore, the numerical suffix is irrelevant in this operating mode.*

## CALCulate:DELTamarker Subsystem

The CALCulate:DELTamarker subsystem controls the delta-marker functions in the instrument. The measurement windows are selected via CALCulate1 (screen A) or 2 (screen B).

COMMAND	PARAMETERS	UNIT	COMMENT
CALCulate<1 2>			
:DELTamarker<1 to 4>			
[:STATe]	<Boolean>	--	
:MODE	ABSolute RELative		
:AOff			no query
:TRACe	<numeric_value>	--	
:X	<numeric_value>	HZ   S   DBM   DB	
:RELative?	--	--	query only
:Y?	--	--	query only
:MAXimum			
[:PEAK]	--	--	no query
:NEXT	--	--	no query
:RIGHT	--	--	no query
:LEFT	--	--	no query
:MINimum			
[:PEAK]	--	--	no query
:NEXT	--	--	no query
:RIGHT	--	--	no query
:LEFT	--	--	no query
:FUNCTion			
:FIXed			
[:STATe]	<Boolean>		
:RPOint			
:Y	<numeric_value>	DBM	
:OFFSet	<numeric_value>	DB	
:X	<numeric_value>	HZ   S	
:PNOise			
[:STATe]	<Boolean>		
:RESult?	--	--	query only

### CALCulate<1|2>:DELTamarker<1 to 4>[:STATe] ON | OFF

This command switches on and off the delta marker when delta marker 1 is selected. The corresponding marker becomes the delta marker when delta marker 2 to 4 is selected. If the corresponding marker is not activated, it will be activated and positioned on the maximum of the measurement curve.

If no numeric suffix is indicated, delta marker 1 is selected automatically.

**Example:** "CALC:DELT3 ON" 'Switches marker 3 in screen A to delta marker mode.

**Characteristics:** \*RST value: OFF  
 SCPI: device-specific

**Mode:** R, A

**CALCulate<1|2>:DELTamarker<1 to 4>:MODE ABSolute | RELative**

This command switches between relative and absolute frequency input of the delta marker (or time with span = 0). It affects all delta markers independent of the measurement window.

**Example:** "CALC:DELT:MODE ABS" 'Switches the frequency/time indication for all delta markers to absolute values.

"CALC:DELT:MODE REL" 'Switches the frequency/time indication for all delta markers to relative to marker 1.

**Characteristics:** \*RST value: REL  
SCPI: device-specific

**Mode:** R, A

**CALCulate<1|2>:DELTamarker<1 to 4>:AOFF**

This command switches off all active delta markers in the selected measurement window (screen A or screen B).

**Example:** "CALC2:DELT:AOFF" 'Switches off all delta markers in screen B.

**Characteristics:** \*RST value: -  
SCPI: device-specific

**Mode:** R, A

This command is an event and therefore it has no \*RST-value and no query form.

**CALCulate<1|2>:DELTamarker<1 to 4>:TRACe 1 to 3**

This command assigns the selected delta marker to the indicated measurement curve in the indicated measurement window. The selected measurement curve must be active, ie its state must be different from "BLANK".

**Example:** "CALC:DELT3:TRAC 2" 'Assigns deltamarker 3 to trace 2 in screen A.

"CALC:DELT:TRAC 3" 'Assigns deltamarker 1 to trace 3 in screen B.

**Characteristics:** \*RST value: -  
SCPI: device-specific

**Mode:** R, A



**CALCulate<1|2>:DELTamarker<1 to 4>:X 0 to MAX (frequency | sweep time)**

This command positions the selected delta marker in the indicated measurement window to the indicated frequency (span > 0), time (span = 0) or level (APD measurement = ON or CCDFmeasurement = ON). The input is in absolute values or relative to marker 1 depending on the command CALCulate:DELTamarker:MODE. If Reference Fixed measurement (CALCulate:DELTamarker:FUNCTion:FIXed:STATE ON) is active, relative values refer to the reference position are entered. The query always returns absolute values.

<b>Example:</b>	"CALC:DELT:MOD REL"	'Switches the input for all delta markers to 'relative to marker 1.
	"CALC:DELT2:X 10.7MHz"	'Positions delta marker 2 in screen A '10.7 MHz to the right of marker 1.
	"CALC2:DELT:X?"	'Outputs the absolute frequency/time of delta 'marker 1 in screen B
	"CALC2:DELT:X:REL?"	'Outputs the relative frequency/time/level of 'delta marker 1 in screen B

**Characteristics:** \*RST value: -  
SCPI: device-specific

**Mode:** R, A

**CALCulate<1|2>:DELTamarker<1 to 4>:X:RELative?**

This command queries the frequency (span > 0) or time (span = 0) of the selected delta marker relative to marker 1 or to the reference position ( for CALCulate:DELTamarker:FUNCTion :FIXed:STATE ON). The command activates the corresponding delta marker, if necessary.

<b>Example:</b>	"CALC:DELT3:X:REL?"	'Outputs the frequency of delta marker 3 in 'screen B relative to marker 1 or relative to the 'reference position.
-----------------	---------------------	--

**Characteristics:** \*RST value: -  
SCPI: device-specific

**Mode:** R, A

**CALCulate<1|2>:DELTamarker<1 to 4>:Y?**

This command queries the measured value of the selected delta marker in the indicated measurement window. The corresponding delta marker will be activated, if necessary. The output is always a relative value referred to marker 1 or to the reference position (reference fixed active).

To obtain a valid query result, a complete sweep with synchronization to the sweep end must be performed between the activation of the delta marker and the query of the y-value. This is only possible in single sweep mode. In receiver mode, the markers can be only activated after a scan is carried out.

Depending on the unit defined with `CALC:UNIT` or on the activated measuring functions, the query result is output in the units below:

- DBM | DBPW | DBUV | DBMV | DBUA:            Output unit DB
- WATT | VOLT | AMPere:                        Output unit W | V | A
- Statistics function (APD or CCDF) on:       Dimensionless output

**Example:**

"INIT:CONT OFF"	'Switches to single-sweep mode.
"CALC:DELT2 ON"	'Switches on delta marker 2 in screen A.
"INIT;*WAI"	'Starts a sweep and waits for its end.
"CALC:DELT2:Y?"	'Outputs measurement value of delta marker 2 in screen A.

**Characteristics:** \*RST value: -  
SCPI: device-specific

**Mode:** R, A

**CALCulate<1|2>:DELTamarker<1 to 4>:MAXimum[:PEAK]**

This command positions the delta marker to the current maximum value on the measured curve. If necessary, the corresponding delta marker will be activated first.

**Example:**

"CALC2:DELT3:MAX"	'Sets delta marker 3 in screen B to the maximum value of the associated trace.
-------------------	--

**Characteristics:** \*RST value: -  
SCPI: device-specific

**Mode:** R, A

This command is an event and is therefore not assigned an \*RST value and has no query.

**CALCulate<1|2>:DELTamarker<1 to 4>:MAXimum:NEXT**

This command positions the delta marker to the next smaller maximum value on the measured curve. The corresponding delta marker will be activated first, if necessary.

**Example:**

"CALC1:DELT2:MAX:NEXT"	'Sets delta marker 2 in screen A to the next smaller maximum value.
------------------------	---

**Characteristics:** \*RST value: -  
SCPI: device-specific

**Mode:** R, A

This command is an event and is therefore not assigned an \*RST value and has no query.

**CALCulate<1|2>:DELTAmarker<1 to 4>:MAXimum:RIGHT**

This command positions the delta marker to the next smaller maximum value to the right of the current value (ie ascending X values). The corresponding delta marker is activated first, if necessary.

**Example:** "CALC2:DELTA:MAX:RIGHT" 'Sets delta marker 1 in screen B to the next 'smaller maximum value to the right of the 'current value.

**Characteristics:** \*RST value: -  
SCPI: device-specific

**Mode:** R, A

This command is an event and is therefore not assigned an \*RST value and has no query.

**CALCulate<1|2>:DELTAmarker<1 to 4>:MAXimum:LEFT**

This command positions the delta marker to the next smaller maximum value to the left of the current value (ie descending X values). The corresponding delta marker will be activated first, if necessary.

**Example:** "CALC:DELTA:MAX:LEFT" 'Sets delta marker 1 in screen A to the next 'smaller maximum value to the left of the 'current value.

**Characteristics:** \*RST value: -  
SCPI: device-specific

**Mode:** R, A

This command is an event and is therefore not assigned an \*RST value and has no query.

**CALCulate<1|2>:DELTAmarker<1 to 4>:MINimum[:PEAK]**

This command positions the delta marker to the current minimum value on the measured curve. The corresponding delta marker will be activated first, if necessary.

**Example:** "CALC2:DELTA3:MIN" 'Sets delta marker 3 in screen B to the 'minimum value of the associated trace.

**Characteristics:** \*RST value: -  
SCPI: device-specific

**Mode:** R, A

This command is an event and is therefore not assigned an \*RST value and has no query.

**CALCulate<1|2>:DELTAmarker<1 to 4>:MINimum:NEXT**

This command positions the delta marker to the next higher minimum value of the measured curve. The corresponding delta marker will be activated first, if necessary.

**Example:** "CALC1:DELTA2:MIN:NEXT" 'Sets delta marker 2 in screen A to the next 'higher minimum value.

**Characteristics:** \*RST value: -  
SCPI: device-specific

**Mode:** R, A

This command is an event and is therefore not assigned an \*RST value and has no query.

**CALCulate<1|2>:DELTamarker<1 to 4>:MINimum:RIGHT**

This command positions the delta marker to the next higher minimum value to the right of the current value (ie ascending X values). The corresponding delta marker will be activated first, if necessary.

**Example:** "CALC2:DELT:MIN:RIGH" 'Sets delta marker 1 in screen B to the next 'higher minimum value to the right of the current value.

**Characteristics:** \*RST value: -  
SCPI: device-specific

**Mode:** R, A

This command is an event and is therefore not assigned an \*RST value and has no query.

**CALCulate<1|2>:DELTamarker<1 to 4>:MINimum:LEFT**

This command positions the delta marker to the next higher minimum value to the left of the current value (ie descending X values). The corresponding delta marker will be activated first, if necessary.

**Example:** "CALC:DELT:MIN:LEFT" 'Sets delta marker 1 in screen A to the next 'higher minimum to the left of the current value.

**Characteristics:** \*RST value: -  
SCPI: device-specific

**Mode:** R, A

This command is an event and is therefore not assigned an \*RST value and has no query.

**CALCulate<1|2>:DELTamarker<1 to 4>:FUNCTION:FIXed[:STATe] ON | OFF**

This command switches the relative measurement to a fixed reference value on or off. Marker 1 will be activated previously and a peak search will be performed, if necessary. If marker 1 is activated, its position becomes the reference point for the measurement. The reference point can then be modified with commands CALCulate:DELTamarker:FUNCTION:FIXed:RPOint:X and . . . :RPOint:Y independently of the position of marker 1 and of a trace. It is valid for all delta markers in the selected measurement window as long as the function is active.

**Example:** "CALC2:DELT:FUNC:FIX ON" 'Switches on the measurement with fixed 'reference value for all delta markers in 'screen B.

"CALC2:DELT:FUNC:FIX:RPO:X 128 MHZ" 'Sets the reference frequency 'in screen B to 128 MHz.

"CALC2:DELT:FUNC:FIX:RPO:Y 30 DBM" 'Sets the reference level in 'screen B to +30 dBm

**Characteristics:** \*RST value: OFF  
SCPI: device-specific.

**Mode:** A

**CALCulate<1|2>:DELTamarker<1 to 4>:FUNCTION:FIXed:RPOint:MAXimum[:PEAK] <num\_value>**

This command sets the reference point level for all delta markers in the selected measurement window for a measurement with fixed reference point. (CALC:DELT:FUNC:FIX:STAT ON) to the peak of the selected trace.

For phase-noise measurements (CALCulate:DELTamarker:FUNCTION:PNOise:STATE ON), the command defines a new reference point level for delta marker 2 in the selected measurement window.

**Example:** "CALC:DELT:FUNC:FIX:RPO:MAX" 'Sets the reference point level for 'delta markers in screen A to the 'peak of the selected trace.

**Characteristics:** \*RST value: -  
SCPI: device-specific

**Mode:** A

This command is an event and is therefore not assigned an \*RST value and has no query.

**CALCulate<1|2>:DELTamarker<1 to 4>:FUNCTION:FIXed:RPOint:Y <numeric\_value>**

This command defines a new reference point level for all delta markers in the selected measurement window for a measurement with fixed reference point.

(CALCulate:DELTamarker:FUNCTION:FIXed:STATE ON).

For phase-noise measurements (CALCulate:DELTamarker:FUNCTION:PNOise:STATE ON), the command defines a new reference point level for delta marker 2 in the selected measurement window.

**Example:** "CALC:DELT:FUNC:FIX:RPO:Y -10dBm" 'Sets the reference point level for 'delta markers in screen A to -10 'dBm.

**Characteristics:** \*RST value: - (FUNCTION:FIXed[:STATE] is set to OFF)  
SCPI: device-specific

**Mode:** A

**CALCulate<1|2>:DELTamarker<1 to 4>:FUNCTION:FIXed:RPOint:Y:OFFSet <numeric\_value>**

This command defines an additional level offset for the measurement with fixed reference value (CALCulate:DELTamarker:FUNCTION:FIXed:STATE ON). For this measurement, the offset is included in the display of all delta markers of the selected measurement window.

For phase-noise measurements (CALCulate:DELTamarker:FUNCTION:PNOise:STATE ON), the command defines an additional level offset which is included in the display of delta marker 2 in the selected measurement window.

**Example:** "CALC:DELT:FUNC:FIX:RPO:Y:OFFS 10dB" 'Sets the level offset for the measurement with fixed reference 'value or the phase-noise measurement in screen A to 10 dB.

**Characteristics:** \*RST value: 0 dB  
SCPI: device-specific

**Mode:** A

**CALCulate<1|2>:DELTamarker<1 to 4>:FUNction:FIXed:RPOint:X** <numeric\_value>

This command defines a new reference frequency (span > 0) or time (span = 0) for all delta markers in the selected measurement window for a measurement with fixed reference value (CALCulate:DELTamarker:FUNction:FIXed:STATe ON).

For phase-noise measurements (CALCulate:DELTamarker:FUNction:PNOise:STATe ON), the command defines a new reference frequency or time for delta marker 2 in the selected measurement window.

**Example:** "CALC2:DELT:FUNC:FIX:RPO:X 128MHZ" 'Sets the reference frequency in 'screen B to 128 MHz.

**Characteristics:** \*RST value: - (FUNction:FIXed[:STATe] is set to OFF)  
SCPI: device-specific

**Mode:** A

**CALCulate<1|2>:DELTamarker<1 to 4>:FUNction:PNOise[:STATe]** ON | OFF

This command switches on or off the phase-noise measurement with all active delta markers in the selected measurement window. The correction values for the bandwidth and the log amplifier are taken into account in the measurement.

Marker 1 will be activated, if necessary, and a peak search will be performed. If marker 1 is activated, its position becomes the reference point for the measurement.

The reference point can then be modified with commands CALCulate:DELTamarker:FUNction:FIXed:RPOint:X and ...:RPOint:Y independently of the position of marker 1 and of a trace (the same commands used for the measurement with fixed reference point).

The numeric suffix <1 to 4> with DELTAmarker is not relevant for this command.

**Example:** "CALC:DELT:FUNC:PNO ON" 'Switches on the phase-noise measurement 'with all delta markers in screen A.  
"CALC:DELT:FUNC:FIX:RPO:X 128 MHZ" 'Sets the reference frequency 'to 128 MHz.  
"CALC:DELT:FUNC:FIX:RPO:Y 30 DBM" 'Sets the reference level to '+30 dBm

**Characteristics:** \*RST value: OFF  
SCPI: device-specific

**Mode:** A

**CALCulate<1|2>:DELTamarker<1 to 4>:FUNction:PNOise:RESult?**

This command queries the result of the phase-noise measurement in the selected measurement window. The measurement will be switched on, if necessary.

**Example:** "CALC:DELT:FUNC:PNO:RES?" 'Outputs the result of phase-noise 'measurement of the selected delta marker in 'screen A.

**Characteristics:** \*RST value: -  
SCPI: device-specific

**Mode:** A

This command is only a query and is therefore not assigned an \*RST value.

## CALCulate:LIMit Subsystem

The CALCulate:LIMit subsystem consists of the limit lines and the corresponding limit checks. In receiver mode upper limit lines can be defined. In analyzer mode, limit lines can be defined as upper or lower limit lines. The individual Y values of the limit lines correspond to the values of the X-axis (CONTRol). The number of X- and Y-values must be identical.

8 limit lines can be active at the same time (marked by LIMIT1 to LIMIT8) in screen A and/or screen B. The measurement windows is selected via CALCulate 1 (screen A) or 2 (screen B).

The limit check can be switched on separately for each measurement screen and limit line. WINDow1 corresponds to screen A, WINDow2 to screen B.

Each limit line can be assigned a name (max. 8 letters) under which the line is stored in the instrument. An explanatory comment can also be given for each line (max. 40 characters).

### Example (analyzer mode):

Definition and use of a new limit line 5 for trace 2 in screen A and trace 1 in screen B with the following features:

- upper limit line
- absolute X-axis in the frequency domain
- 5 ref. values: 126 MHz/-40 dB, 127 MHz/-40 dB, 128 MHz/-20 dB, 129 MHz/-40 dB, 130 MHz/-40 dB
- relative Y-axis with unit dB
- absolute threshold value at -35 dBm
- no safety margin

### Definition of the line:

- |                                     |   |
|-------------------------------------|---|
| 1. Defining the name:               | CALC:LIM5:NAME 'TEST1'                                    |
| 2. Entering the comment:            | CALC:LIM5:COMM 'Upper limit line'                         |
| 3. Associated trace in screen A:    | CALC1:LIM5:TRAC 2   |
| 4. Associated trace in screen B:    | CALC2:LIM5:TRAC 1   |
| 5. Defining the X-axis range:       | CALC:LIM5:CONT:DOM FREQ                                   |
| 6. Defining the X-axis scaling:     | CALC:LIM5:CONT:MODE ABS                                   |
| 7. Defining the Y-axis unit:        | CALC:LIM5:UNIT DB   |
| 8. Defining the Y-axis scaling:     | CALC:LIM5:UPP:MODE REL                                    |
| 9. Defining the X-axis values:      | CALC:LIM5:CONT 126MHZ, 127MHZ, 128MHZ,<br>129 MHZ, 130MHZ |
| 10. Defining the y values:          | CALC:LIM5:UPP -40, -40, -30, -40, -40                     |
| 11. Defining the y threshold value: | CALC:LIM5:UPP:THR -35DBM                                  |

The definition of the safety margin and shifting in X- and/or Y-direction can take place as from here (see commands below).

### Switching on and evaluating the line in screen A:

- |   |                        |
|---|------------------------|
| 1. Switching on the line in screen A:               | CALC1:LIM5:UPP:STAT ON |
| 2. Switching on the limit check in screen A:        | CALC1:LIM5:STAT ON     |
| 3. Starting a new measurement with synchronization: | INIT;*WAI              |
| 4. Querying the limit check result:                 | CALC1:LIM5:FAIL?       |

Switching on and evaluating the line in screen B is performed in the same way by using CALC2 instead of CALC1.

COMMAND	PARAMETERS	UNIT	COMMENT
CALCulate<1 2> :LIMit<1 to 8> :TRACe :STATe :UNIT  :FAIL? :CLEAr [:IMMediate] :COMMeNt :COpy :NAME :DELete	<numeric_value>  <Boolean> DBM   DBPW   WATT   DBUV   DBMV   VOLT   DBPT   DBUA   AMPere   DB   DBUV_M   DBUA_M   DEG   RAD   S   HZ   PCT   UNITLESS	--          --  --  --  --	           query only   no query

**CALCulate<1|2>:LIMit<1 to 8>:TRACe 1 to 3**

This command assigns a limit line to a trace in the indicated measurement window.

**Examples:** "CALC:LIM2:TRAC 3" 'Assigns limit line 2 to trace 3 in screen A.  
"CALC2:LIM2:TRAC 1" 'Assigns limit line 2 to trace 1 in screen B at the same time.

**Characteristics:** \*RST value: 1  
SCPI: device-specific

**Mode:** R, A

**CALCulate<1|2>:LIMit<1 to 8>:STATe ON | OFF**

This command switches on or off the limit check for the selected limit line in the selected measurement window.

The result of the limit check can be queried with CALCulate:LIMit<1 to 8>:FAIL?.

**Example:** "CALC:LIM:STAT ON" 'Switches on the limit check for limit line 1 in screen A.  
"CALC2:LIM:STAT OFF" 'Switches off the limit check for limit line 1 in screen B.

**Characteristics:** \*RST value: OFF  
SCPI: conforming

**Mode:** R, A,

**CALCulate<1|2>:LIMit<1 to 8>:UNIT DBM | DBPW | WATT | DBUV | DBMV | VOLT | DBUA | AMPere | DB | DBPT | DBUV\_M | DBMV\_M**

This command defines the unit of the selected limit line. The definition is valid independently of the measurement window.

Upon selection of the unit DB the limit line is automatically switched to the relative mode. For units different from DB the limit line is automatically switched to absolute mode.

**Example:** "CALC:LIM4:UNIT DBUV" 'Sets the unit of limit line 4 to dBµV.

**Characteristics:** \*RST value: DBM  
SCPI: device-specific

**Mode:** R, A

In receiver mode the units DBM, DBUV, DBUA, DBPW, DBPT, DBUV\_M, and DBUA\_M are available In analyzer mode all units are available except for DBPT, DEG, RAD, S, HZ and PCT.



**CALCulate<1|2>:LIMit<1 to 8>:FAIL?**

This command queries the result of the limit check of the limit line indicated in the selected measurement window. It should be noted that a complete sweep must have been performed for obtaining a valid result. A synchronization with \*OPC, \*OPC? or \*WAI should therefore be provided. The result of the limit check responds with 0 for PASS, 1 for FAIL, and 2 for MARGIN.

This command is not available in receiver mode.

**Example:** "INIT; \*WAI" 'Starts a new sweep and waits for its end.  
"CALC2:LIM3:FAIL?" 'Queries the result of the check for limit 'line 3 in screen B.

**Characteristics:** \*RST value: -  
SCPI: conforming

**Mode:** A

**CALCulate<1|2>:LIMit<1 to 8>:CLEar[:IMMediate]**

This command deletes the result of the current limit check for all limit lines in the selected measurement window.

This command is not available in receiver mode.

**Example:** "CALC:LIM:CLE" 'Deletes the result of the limit check in screen A

**Characteristics:** \*RST value: -  
SCPI: conforming

**Mode:** A

This command is an event and is therefore not assigned an \*RST value.

**CALCulate<1|2>:LIMit<1 to 8>:COMMeNT <string>**

This command defines a comment for the limit line selected (max. 40 characters). The comment is independent from the measurement window.

**Example:** "CALC:LIM5:COMM 'Upper limit for spectrum'"  
'Defines the comment for limit line 5.

**Characteristics:** \*RST value: blank comment  
SCPI: device-specific

**Mode:** R, A

**CALCulate<1|2>:LIMit<1 to 8>:COpy 1 to 8 | <name>**

This command copies one limit line onto another one. It is independent of the measurement window.

The name of the limit line may consist of max 8 characters.

**Parameter:** 1 to 8 ::= number of the new limit line or:  
<name> ::= name of the new limit line given as a string

**Example:** "CALC:LIM1:COpy 2" 'Copies limit line 1 to line 2.  
"CALC:LIM1:COpy 'GSM2' " 'Copies limit line 1 to a new line named "GSM2'.

**Characteristics:** \*RST value: --  
SCPI: device-specific

**Mode:** R, A

This command is an event and is therefore not assigned an \*RST value and has no query.

**CALCulate<1|2>:LIMit<1 to 8>:NAME** <name of limit line>

This command assigns a name to a limit line numbered 1 to 8. If it does not exist already, a limit line with this name is created. The command is independent of the measurement window.

The name of the limit line may contain a maximum of 8 characters.

**Example:** "CALC:LIM1:NAME 'GSM1' " 'Assigns the name 'GSM1' to limit line 1.

**Characteristics:** \*RST value: 'REM1' to 'REM8' for lines 1 to 8  
SCPI: device-specific

**Mode:** R, A

**CALCulate<1|2>:LIMit<1 to 8>:DELeTe**

This command deletes the selected limit line. The command is independent of the measurement window.

**Example:** "CALC:LIM1:DEL" 'Deletes limit line 1.

**Characteristics:** \*RST value: --  
SCPI: device-specific

**Mode:** R, A

This command is an event and is therefore not assigned an \*RST value and has no query.

**CALCulate:LIMit:ACPower Subsystem**

The CALCulate:LIMit:ACPower subsystem defines the limit check for adjacent channel power measurement.

COMMAND	PARAMETERS	UNIT	COMMENT
CALCulate<1 2> LIMit<1 to 8> :ACPower [:STATe] :ACHannel [:RELative] :STATe :ABSolute :STATe :RESult? :ALternate<1 2> [:RELative] :STATe :ABSolute :STATe :RESult?	<Boolean>  <numeric_value>, <numeric_value> <Boolean> <numeric_value>, <numeric_value> <Boolean> -- <numeric_value>, <numeric_value> <Boolean> <numeric_value>, <numeric_value> <Boolean> --	  DB, DB  DBM, DBM    DB, DB  DBM, DBM    DBM, DBM    --	       query only          query only

**CALCulate<1|2>:LIMit<1 to 8>:ACPower[:STATe] ON | OFF**

This command switches on and off the limit check for adjacent channel power measurements in the selected measurement window. The commands CALCulate:LIMit:ACPower:ACHannel:STATe or CALCulate:LIMit:ACPower:ALternate:STATe must be used in addition to specify whether the limit check is to be performed for the upper/lower adjacent channel or for the alternate adjacent channels.

The numeric suffixes <1 to 8> are irrelevant for this command.

**Example:** "CALC:LIM:ACP ON" 'Switches on the ACP limit check in screen A.

**Characteristics:** \*RST value: OFF  
SCPI: device-specific

**Mode:** A

**CALCulate<1|2>:LIMit<1 to 8>:ACPpower:ACHannel[:RELative]** 0 to 100dB, 0 to 100dB

This command defines the relative limit of the upper/lower adjacent channel for adjacent channel power measurements in the selected measurement window. The reference value for the relative limit value is the measured channel power.

It should be noted that the relative limit value has no effect on the limit check as soon as it is below the absolute limit value defined with `CALCulate:LIMit:ACPpower:ACHannel:ABSolute`. This mechanism allows automatic checking of the absolute basic values of adjacent channel power as defined in mobile radio standards.

The numeric suffixes <1 to 8> are irrelevant for this command.

**Parameter:** The first numeric value is the limit for the upper (lower) adjacent channel. The second value is ignored but must be indicated for reasons of compatibility with the FSE family.

**Example:** `"CALC:LIM:ACP:ACH 30DB, 30DB"` 'Sets the relative limit value in  
'screen A for the power in the lower  
'and upper adjacent channel to  
'30 dB below the channel power.

**Characteristics:** \*RST value: 0 dB  
SCPI: device-specific

**Mode:** A

**CALCulate<1|2>:LIMit<1 to 8>:ACPower:ACHannel[:RELative]:STATe ON | OFF**

This command activates the limit check for the relative limit value of the adjacent channel when adjacent channel power measurement is performed. Before the command, the limit check must be activated using `CALCulate:LIMit:ACPower:STATe ON`.

The result can be queried with `CALCulate:LIMit:ACPower:ACHannel:RESult?`. It should be noted that a complete measurement must be performed between switching on the limit check and the result query, since otherwise no valid results are available.

The numeric suffixes <1 to 8> are irrelevant for this command.

**Example:**

<code>"CALC:LIM:ACP:ACH 30DB, 30DB"</code>	'Sets the relative limit value in screen A for the power in the lower and upper adjacent channel to 30 dB below the channel power.'
<code>"CALC:LIM:ACP:ACH:ABS -35DBM, -35DBM"</code>	'Sets the absolute limit value in screen A for the power in the lower and upper adjacent channel to -35 dBm.'
<code>"CALC:LIM:ACP ON"</code>	'Switches on globally the limit check for the channel/adjacent channel measurement in screen A.'
<code>"CALC:LIM:ACP:ACH:REL:STAT ON"</code>	'Switches on the check of the relative limit values for adjacent channels in screen A.'
<code>"CALC:LIM:ACP:ACH:ABS:STAT ON"</code>	'Switches on the check of absolute limit values for the adjacent channels in screen A.'
<code>"INIT;*WAI"</code>	'Starts a new measurement and waits for the sweep end.'
<code>"CALC:LIM:ACP:ACH:RES?"</code>	'Queries the limit check result in the adjacent channels in screen A.'

**Characteristics:** \*RST value: OFF  
SCPI: device-specific

**Mode:** A

**CALCulate<1|2>:LIMit<1 to 8>:ACPower:ACHannel:ABSolute** -200DBM to 200DBM, -200 to 200DBM

This command defines the absolute limit value for the lower/upper adjacent channel during adjacent-channel power measurement (Adjacent Channel Power) in the selected measurement window.

It should be noted that the absolute limit value has no effect on the limit check as soon as it is below the relative limit value defined with `CALCulate:LIMit:ACPower:ACHannel:RELative`. This mechanism allows automatic checking of the absolute basic values of adjacent channel power as defined in mobile radio standards.

The numeric suffixes <1 to 8> in LIMit are irrelevant for this command.

**Parameter:** The first value is the limit for the lower and the upper adjacent channel. The second limit value is ignored but must be indicated for reasons of compatibility with the FSE family.

**Example:** `"CALC:LIM:ACP:ACH:ABS -35DBM, -35DBM"`

'Sets the absolute limit value in  
'screen A for the power in the lower  
'and upper adjacent channel to  
'-35 dBm.

**Characteristics:** \*RST value: -200DBM  
SCPI: device-specific

**Mode:** A

**CALCulate<1|2>:LIMit<1 to 8>:ACPpower:ACHannel:ABSolute:STATe ON | OFF**

This command activates the limit check for the adjacent channel when adjacent-channel power measurement (Adjacent Channel Power) is performed. Before the command, the limit check for the channel/adjacent-channel measurement must be globally switched on using `CALC:LIM:ACP ON`.

The result can be queried with `CALCulate:LIMit:ACPpower:ACHannel:RESult?`. It should be noted that a complete measurement must be performed between switching on the limit check and the result query, since otherwise no valid results are available.

The numeric suffixes <1 to 8> in LIMit are irrelevant for this command.

<b>Example:</b>	<code>"CALC:LIM:ACP:ACH 30DB, 30DB"</code>	'Sets the relative limit value in screen A for the power in the lower and upper adjacent channel to 30 dB below the channel power.
	<code>"CALC:LIM:ACP:ACH:ABS -35DBM, -35DBM"</code>	'Sets the absolute limit value in screen A for the power in the lower and upper adjacent channel to -35 dBm.
	<code>"CALC:LIM:ACP ON"</code>	'Switches on globally the limit check for the channel/adjacent channel measurement in screen A.
	<code>"CALC:LIM:ACP:ACH:REL:STAT ON"</code>	'Switches on the check of the relative limit values for adjacent channels in screen A.
	<code>"CALC:LIM:ACP:ACH:ABS:STAT ON"</code>	'Switches on the check of absolute limit values for the adjacent channels in screen A.
	<code>"INIT;*WAI"</code>	'Starts a new measurement and waits for the sweep end.
	<code>"CALC:LIM:ACP:ACH:RES?"</code>	'Queries the limit check result in the adjacent channels in screen A.

**Characteristics:** \*RST value: OFF  
SCPI: device-specific

**Mode:** A

**CALCulate<1|2>:LIMit<1 to 8>:ACPpower:ACHannel:RESult?**

This command queries the result of the limit check for the upper/lower adjacent channel in the selected measurement window when adjacent channel power measurement is performed.

If the power measurement of the adjacent channel is switched off, the command produces a query error.

The numeric suffixes <1 to 8> are irrelevant for this command.

**Parameter:** The result is returned in the form <result>, <result> where <result> = PASSED | FAILED, and where the first returned value denotes the lower, the second denotes the upper adjacent channel.

**Example:**

"CALC:LIM:ACP:ACH 30DB, 30DB"	'Sets the relative limit value in screen A for the power in the lower and upper adjacent channel to 30 dB below the channel power.
"CALC:LIM:ACP:ACH:ABS -35DBM, -35DBM"	Sets the absolute limit value in screen A for the power in the lower and upper adjacent channel to -35 dB.
"CALC:LIM:ACP ON"	'Switches on globally the limit check for the channel/adjacent channel measurement in screen A.
"CALC:LIM:ACP:ACH:STAT ON"	'Switches on the limit check for the adjacent channels in screen A.
"INIT;*WAI"	'Starts a new measurement and waits for the sweep end.
"CALC:LIM:ACP:ACH:RES?"	'Queries the limit check result in the adjacent channels in screen A.

**Characteristics:** \*RST value: --  
SCPI: device-specific

**Mode:** A

This command is a query and therefore not assigned an \*RST value.



**CALCulate<1|2>:LIMit<1 to 8>:ACPower:ALternate<1|2>[:RELative]** 0 to 100dB, 0 to 100dB.

This command defines the limit for the first/second alternate adjacent channel in the selected measurement window for adjacent channel power measurements. The reference value for the relative limit value is the measured channel power.

The numeric suffix after `ALternate<1|2>` denotes the first or the second alternate channel. The numeric suffixes <1 to 8> are irrelevant for this command.

It should be noted that the relative limit value has no effect on the limit check as soon as it is below the absolute limit defined with `CALCulate:LIMit:ACPower:ALternate<1|2>:ABSolute`. This mechanism allows automatic checking of the absolute basic values of adjacent channel power as defined in mobile radio standards.

**Parameter:** The first value is the limit for the lower and the upper alternate adjacent channel. The second limit value is ignored but must be indicated for reasons of compatibility with the FSE family.

**Example:** `"CALC:LIM:ACP:ALT2 30DB, 30DB"` 'Sets the relative limit value in  
'screen A for the power in the lower  
'and upper alternate adjacent  
'channel to 30 dB below the channel  
'power.

**Characteristics:** \*RST value: 0DB  
SCPI: device-specific

**Mode:** A

**CALCulate<1|2>:LIMit<1 to 8>:ACPpower:ALternate<1|2>[:RELative]:STATe ON | OFF**

This command activates the limit check for the first/second alternate adjacent channel in the selected measurement window for adjacent channel power measurements. Before the command, the limit check must be activated using `CALCulate:LIMit:ACPpower:STATe ON`.

The numeric suffix after `ALternate<1|2>` denotes the first or the second alternate channel. The numeric suffixes <1 to 8> are irrelevant for this command.

The result can be queried with `CALCulate:LIMit:ACPpower:ALternate<1|2>:RESult?`. It should be noted that a complete measurement must be performed between switching on the limit check and the result query, since otherwise no valid results are obtained.

**Example:**

```
"CALC:LIM:ACP:ALT2 30DB, 30DB"
'Sets the relative limit value in screen A for the
'power in the lower and upper second alternate
'adjacent channel to 30 dB below the channel
'power.

"CALC:LIM:ACP:ALT2:ABS -35DBM, -35DBM"
'Sets the absolute limit value in screen A for the
'power in the lower and upper second alternate
'adjacent channel to -35 dBm.

"CALC:LIM:ACP ON"
'Switches on globally the limit check for the
'channel/adjacent channel measurement in
'screen A.

"CALC:LIM:ACP:ACH:REL:STAT ON"
'Switches on the check of the relative limit
'values for the alternate adjacent channels in
'screen A.

"CALC:LIM:ACP:ACH:ABS:STAT ON"
'Switches on the check of absolute limit values
'for the alternate adjacent channels in screen A.

"INIT;*WAI"
'Starts a new measurement and waits for the
'sweep end.

"CALC:LIM:ACP:ACH:RES?"
'Queries the limit check result in the second
'alternate adjacent channels in screen A.
```

**Characteristics:** \*RST value: OFF  
SCPI: device-specific

**Mode:** A

**CALCulate<1|2>:LIMit<1 to 8>:ACPower:ALternate<1|2>:ABSolute** -200DBM to 200DBM,  
-200DBM to .200DBM

This command defines the absolute limit value for the lower/upper alternate adjacent channel power measurement (Adjacent Channel Power) in the selected measurement window.

The numeric suffix after `ALternate<1|2>` denotes the first or the second alternate channel. The numeric suffixes <1 to 8> are irrelevant for this command.

It should be noted that the absolute limit value for the limit check has no effect as soon as it is below the relative limit value defined with `CALCulate:LIMit:ACPower:ALternate<1|2>:RELative`. This mechanism allows automatic checking of the absolute basic values defined in mobile radio standards for the power in adjacent channels.

**Parameter:** The first value is the limit for the lower and the upper alternate adjacent channel. The second limit value is ignored but must be indicated for reasons of compatibility with the FSE family.

**Example:** `"CALC:LIM:ACP:ALT2:ABS -35DBM, -35DBM"`  
'Sets the absolute limit value in  
'screen A for the power in the lower  
'and upper second alternate  
'adjacent channel to -35 dBm.

**Characteristics:** \*RST value: -200DBM  
SCPI: device-specific

**Mode:** A

**CALCulate<1|2>:LIMit<1 to 8>:ACPpower:ALternate<1|2>:ABSolute:STATe ON | OFF**

This command activates the limit check for the first/second alternate adjacent channel in the selected measurement window for adjacent channel power measurement (Adjacent Channel Power).

Before the command, the limit check must be globally switched on for the channel/adjacent channel power with the command `CALCulate:LIMit:ACPpower:STATe ON`.

The numeric suffix after `ALternate<1|2>` denotes the first or the second alternate channel. The numeric suffixes <1 to 8> are irrelevant for this command.

The result can be queried with `CALCulate:LIMit:ACPpower:ALternate<1|2>:RESult?`. It should be noted that a complete measurement must be performed between switching on the limit check and the result query, since otherwise no valid results are available.

**Example:**

<code>"CALC:LIM:ACP:ALT2 30DB, 30DB"</code>	'Sets the relative limit value in screen A for the power in the lower and upper second alternate adjacent channel to 30 dB below the channel power.'
<code>"CALC:LIM:ACP:ALT2:ABS -35DBM, -35DBM"</code>	'Sets the absolute limit value in screen A for the power in the lower and upper second alternate adjacent channel to -35 dBm.'
<code>"CALC:LIM:ACP ON"</code>	'Switches on globally the limit check for the channel/adjacent channel measurement in screen A.'
<code>"CALC:LIM:ACP:ACH:REL:STAT ON"</code>	Switches on the check of the relative limit values for the alternative adjacent channels in screen A.
<code>"CALC:LIM:ACP:ACH:ABS:STAT ON"</code>	'Switches on the check of absolute limit values for the alternative adjacent channels in screen A.'
<code>"INIT;*WAI"</code>	'Starts a new measurement and waits for the sweep end.'
<code>"CALC:LIM:ACP:ACH:RES?"</code>	'Queries the limit check result in the second alternate adjacent channels in screen A.'

**Characteristics:** \*RST value: OFF  
SCPI: device-specific

**Mode:** A

**CALCulate<1|2>:LIMit<1 to 8>:ACPpower:ALternate<1|2>:RESult?**

This command queries the result of the limit check for the first/second alternate adjacent channel in the selected measurement window for adjacent channel power measurements.

The numeric suffix after `ALternate<1|2>` denotes the first or the second alternate channel. The numeric suffixes <1 to 8> are irrelevant for this command.

If the power measurement of the adjacent channel is switched off, the command produces a query error.

**Parameter:** The result is returned in the form <result>, <result> where <result> = PASSED | FAILED and where the first (second) returned value denotes the lower (upper) alternate adjacent channel.

**Example:**

" <code>CALC:LIM:ACP:ALT2 30DB, 30DB</code> "	'Sets the relative limit value in screen A for the power in the lower and upper second alternate adjacent channel to 30 dB below the channel power.'
" <code>CALC:LIM:ACP:ALT2:ABS -35DBM, -35DBM</code> "	'Sets the absolute limit value in screen A for the power in the lower and upper second alternate adjacent channel to -35 dBm.'
" <code>CALC:LIM:ACP ON</code> "	'Switches on globally the limit check for the channel/adjacent channel measurement in screen A.'
" <code>CALC:LIM:ACP:ALT:STAT ON</code> "	'Switches on the limit check for the adjacent channels in screen A.'
" <code>INIT; *WAI</code> "	'Starts a new measurement and waits for the sweep end.'
" <code>CALC:LIM:ACP:ALT:RES?</code> "	'Queries the limit check result in the second alternate adjacent channels in screen A.'

**Characteristics:** \*RST value: --  
SCPI: device-specific

**Mode:** A

This command is a query and therefore not assigned an \*RST value.

**CALCulate:LIMit:CONTrol Subsystem**

The CALCulate:LIMit:CONTrol subsystem defines the x-axis (CONTrol-axis).

COMMAND	PARAMETERS	UNIT	COMMENT
CALCulate<1 2> :LIMit<1 to 8> :CONTrol [:DATA] :DOMain :OFFSet :MODE :SHIFt :SPACing	<numeric_value>,<numeric_value>.. FREQuency TIME <numeric_value> RELative ABSolute <numeric_value> LINear   LOGarithmic	HZ   S  HZ   S  HZ   S	

**CALCulate<1|2>:LIMit<1 to 8>:CONTrol[:DATA] <numeric\_value>,<numeric\_value>..**

This command defines the X-axis values (frequencies or times) of the upper or lower limit lines. The values are defined independently of the measurement window.

The number of values for the CONTrol axis and for the corresponding UPPer and/or LOWEr limit lines have to be identical. Otherwise default values are entered for missing values or not required values are deleted.

In analyzer mode, the unit of values depends on the frequency or time domain of the X-axis, ie it is HZ with CALC:LIM:CONT:DOM FREQ und S bei CALC:LIM:CONT:DOM TIME.

**Example:** "CALC:LIM2:CONT 1MHz,30MHz,100MHz, 300MHz,1GHz" 'Defines 5 reference values for the X-axis of 'limit line 2  
"CALC:LIM2:CONT?" 'Outputs the reference values for the X-axis of 'limit line 2 separated by a comma.

**Characteristics:** \*RST value: - (LIMit:STATe is set to OFF)  
SCPI: conforming

**Mode:** R, A

**CALCulate<1|2>:LIMit<1 to 8>:CONTrol:DOMain FREQuency | TIME**

This command defines the frequency or time domain for the x-axis values.

**Example:** "CALC:LIM2:CONT:DOM TIME" 'Defines the time domain for the X-axis of limit 'line 2.

**Characteristics:** \*RST value: FREQuency  
SCPI: device-specific

**Mode:** A

**CALCulate<1|2>:LIMit<1 to 8>:CONTRol:OFFSet** <numeric\_value>

This command defines an offset for the X-axis value of the selected relative limit line in the frequency or time domain.

The unit of values depends on the frequency or time domain of the X-axis, ie it is HZ with `CALC:LIM:CONT:DOM FREQ` und S bei `CALC:LIM:CONT:DOM TIME`.

**Example:** `"CALC:LIM2:CONT:OFFS 100us"` 'Sets the X offset for limit line 2 (defined in the time domain) to 100µs.

**Characteristics:** \*RST value: 0  
SCPI: device-specific

**Mode:** A

**CALCulate<1|2>:LIMit<1 to 8>:CONTRol:MODE** RELative | ABSolute

This command selects the relative or absolute scaling for the X-axis of the selected limit line. The definition is independent of the measurement window.

**Example:** `"CALC:LIM2:CONT:MODE REL"` 'Defines the X-axis of limit line 2 as relatively scaled.

**Characteristics:** \*RST value: ABSolute  
SCPI: device-specific

**Mode:** A

**CALCulate<1|2>:LIMit<1 to 8>:CONTRol:SHIFt** <numeric\_value>

This command moves a limit line by the indicated value in x direction. In contrast to `CALC:LIM:CONT:OFFS`, the line is shifted by modifying the individual x values and not by means of an additive offset. The shift is independent of the measurement window.

In the analyzer mode, the unit of values depends on the frequency or time domain of the X-axis, ie it is HZ with `CALC:LIM:CONT:DOM FREQ` und S bei `CALC:LIM:CONT:DOM TIME`.

**Example:** `"CALC:LIM2:CONT:SHIF 50KHZ"` 'Shifts all reference values of limit line 2 by 50 kHz.

**Characteristics:** \*RST value: --  
SCPI: device-specific

**Mode:** R, A

This command is an event and is therefore not assigned an \*RST value and has no query.

**CALCulate<1|2>:LIMit<1 to 8>:CONTRol:SPACing** LINear | LOGarithmic

This command makes a selection between linear and logarithmic interpolation for determining the limit line from the frequency points.

**Example:** `"CALC:LIM:CONT:SPAC LIN"`

**Features:** \*RST value: LIN  
SCPI: device-specific

**Modes:** R, A

### CALCulate:LIMit:LOWer Subsystem

The CALCulate:LIMit:LOWer subsystem defines the lower limit line. This subsystem is not available in receiver mode.

COMMAND	PARAMETERS	UNIT	COMMENT
CALCulate<1 2> :LIMit<1 to 8> :LOWer [ :DATA]	<numeric_value>,<numeric_value>..	DBM   DB   DEG   RAD   S   HZ   PCT	
:STATe	<Boolean>	--	
:OFFSet	<numeric_value>	DB  DEG  RAD  S   HZ   PCT	
:MARGin	<numeric_value>	DB  DEG  RAD  S   HZ   PCT	
:MODE	RELative ABSolute	--	
:SHIFt	<numeric_value>	DB  DEG  RAD  S   HZ   PCT	
:SPACing	LINear   LOGarithmic		
:THReshold	<numeric_value>	DBM   DB   DEG   RAD   S   HZ   PCT	

**CALCulate<1|2>:LIMit<1 to 8>:LOWer[:DATA] <numeric\_value>,<numeric\_value>..**

This command defines the values for the selected lower limit line independently of the measurement window.

The number of values for the CONTROL axis and for the corresponding LOWER limit line has to be identical. Otherwise default values are entered for missing values or not necessary values are deleted.

The unit must be identical with the unit selected by CALC : LIM : UNIT. If no unit is indicated, the unit defined with CALC : LIM : UNIT is automatically used.

If the measured values are smaller than the LOWER limit line, the limit check signals errors.

**Example:** "CALC : LIM2 : LOW -30 , -40 , -10 , -40 , -30 " 'Defines 5 lower limit values for limit line 2 in 'the preset unit.  
"CALC : LIM2 : LOW ? " 'Outputs the lower limit values of limit line 2 'separated by a comma.

**Characteristics:** \*RST value: - (LIMit:STATe is set to OFF)  
SCPI: conforming

**Mode:** A



**CALCulate<1|2>:LIMit<1 to 8>:LOWer:STATe** ON | OFF

This command switches on or off the indicated limit line in the selected measurement window. The limit check is activated separately with `CALC:LIM:STAT ON`.

In analyzer mode, the result of the limit check can be queried with `CALCulate:LIMit<1 to 8>:FAIL?`.

**Example:**           `"CALC:LIM4:LOW:STAT ON"`           'Switches on limit line 4 (lower limit) in 'screen A.  
                   `"CALC2:LIM4:LOW:STAT ON"`           'Switches on limit line 4 (lower limit) also in 'screen B.

**Characteristics:** \*RST value:   OFF  
                       SCPI:           conforming

**Mode:**            A

**CALCulate<1|2>:LIMit<1 to 8>:LOWer:OFFSet** <numeric\_value>

This command defines an offset for the Y-axis of the selected relative lower limit line. In contrast to `CALC:LIM:LOW:SHIFT`, the line is not shifted by modifying the individual Y values but by means of an additive offset. The offset is independent of the measurement window.

**Example:**           `"CALC:LIM2:LOW:OFFS 3dB"`           'Shifts limit line 2 in the corresponding 'measurement windows by 3 dB upwards.

**Characteristics:** \*RST value:   0  
                       SCPI:           device-specific

**Mode:**            A

**CALCulate<1|2>:LIMit<1 to 8>:LOWer:MARGin** <numeric\_value>

This command defines a margin to a lower limit line, at which out-of-limit values are signalled (if the limit check is active), but not handled as a violation of the limit value. The margin is independent of the measurement window.

Only the unit dB is available in spectrum analysis mode.

**Example:**           `"CALC:LIM:LOW:MARG 10dB"`

**Characteristics:** \*RST value:   0  
                       SCPI:           device-specific

**Mode:**            A

**CALCulate<1|2>:LIMit<1 to 8>:LOWer:MODE** RELative | ABSolute

This command selects the relative or absolute scaling for the Y-axis of the selected lower limit line. The setting is independent of the measurement window.

Selecting RELative causes the unit to be switched to DB.

**Example:**           `"CALC:LIM:LOW:MODE REL"`           'Defines the Y-axis of limit line 2 as relative 'scaled.

**Characteristics:** \*RST value:   ABSolute  
                       SCPI:           device-specific

**Mode:**            A

**CALCulate<1|2>:LIMit<1 to 8>:LOWer:SHIFt** <numeric\_value>

This command shifts a limit line by the indicated value in Y-direction. In contrast to `CALC:LIM:LOW:OFFS`, the line is shifted by modifying the individual Y values but not by means of an additive offset. The shift is independent of the measurement window.

**Example:** `"CALC:LIM3:LOW:SHIF 20DB"` 'Shifts all Y values of limit line 3 by 20 dB.

**Characteristics:** \*RST value: --  
SCPI: device-specific

**Mode:** A

This command is an event and is therefore not assigned an \*RST value and has no query.

**CALCulate<1|2>:LIMit<1 to 8>:LOWer:SPACing** LINear | LOGarithmic

This command selects linear or logarithmic interpolation for the lower limit line.

**Example:** `"CALC:LIM:LOW:SPAC LIN"`

**Features:** \*RST value: LIN  
SCPI: device-specific

**Mode:** A

**CALCulate<1|2>:LIMit<1 to 8>:LOWer:THReshold** <numeric\_value>

This command defines an absolute threshold value for limit lines with relative Y-axis scaling independently of the measurement window. The absolute threshold value is used in the limit check as soon as it exceeds the relative limit value.

The unit must correspond to the unit selected with `CALC:LIM:UNIT` (except dB which is not allowed). If no unit is indicated, the unit defined with `CALC:LIM:UNIT` is automatically used (exception: dBm instead of dB).

**Example:** `"CALC:LIM2:LOW:THR -35DBM"` 'Defines an absolute threshold value for limit line 2.

**Characteristics:** \*RST value: -200 dBm  
SCPI: device-specific

**Mode:** A

**CALCulate:LIMit:UPPer Subsystem**

The CALCulate:LIMit:UPPer subsystem defines the upper limit line.

COMMAND	PARAMETERS	UNIT	COMMENT
CALCulate<1 2> :LIMit<1 to 8> :UPPer [<DATA>	<numeric_value>,<numeric_value>..	DBM   DB   DEG   RAD   S   HZ   PCT	
:STATe	<Boolean>	--	
:OFFSet	<numeric_value>	DB  DEG  RAD  S   HZ   PCT	
:MARGin	<numeric_value>	DB  DEG  RAD  S   HZ   PCT	
:MODE	RELative ABSolute	--	
:SHIFt	<numeric_value>	DB  DEG  RAD  S   HZ   PCT	
:SPACing	LINear   LOGarithmic		
:THReshold	<numeric_value>	DBM   DB   DEG   RAD   S   HZ   PCT	

**CALCulate<1|2>:LIMit<1 to 8>:UPPer[<DATA>] <numeric\_value>,<numeric\_value>..**

This command defines the values for the upper limit lines independently of the measurement window.

The number of values for the CONTROL axis and for the corresponding UPPER and/or LOWER limit line have to be identical. Otherwise default values are entered for missing values or not necessary values are deleted.

The unit must be identical with the unit selected by CALC:LIM:UNIT. If no unit is indicated, the unit defined with CALC:LIM:UNIT is automatically used.

In analyzer mode, the limit check signals errors if the measured values exceed the UPPER limit line.

**Example:** "CALC:LIM2:UPP -10,0,0,-10,-5" 'Defines 5 upper limit values for limit line 2 in the preset unit.

"CALC:LIM2:UPP?" 'Outputs the upper limit values for limit line 2 separated by a comma.

**Characteristics:** \*RST value: - (LIMit:STATe is set to OFF)  
SCPI: conforming

**Mode:** R, A

**CALCulate<1|2>:LIMit<1 to 8>:UPPer:STATe ON | OFF**

This command switches on or off the indicated limit line in the selected measurement window. The limit check is activated separately with `CALC:LIM:STAT ON`.

In analyzer mode, the result of the limit check can be queried with `CALCulate:LIMit<1 to 8>:FAIL?`.

**Example:**           `"CALC1:LIM4:UPP:STAT ON"`           'Switches on limit line 4 (upper limit) in 'screen A.  
                   `"CALC2:LIM4:UPP:STAT ON"`           'Switches on limit line 4 (upper limit) in 'screen B.

**Characteristics:** \*RST value:   OFF  
                       SCPI:           conforming

**Mode:**            R, A

**CALCulate<1|2>:LIMit<1 to 8>:UPPer:OFFSet <numeric\_value>**

This command defines an offset for the Y-axis of the selected relative upper limit line. In contrast to `CALC:LIM:UPP:SHIFT`, the line is not shifted by modifying the individual Y values but by means of an additive offset. The offset is independent of the measurement window.

Only the unit dB is available in the spectrum analysis mode.

**Example:**           `"CALC:LIM2:UPP:OFFS 3dB"`           'Shifts limit line 2 by 3 dB upwards in the 'corresponding measurement windows.

**Characteristics:** \*RST value:   0  
                       SCPI:           device-specific

**Mode:**            A

**CALCulate<1|2>:LIMit<1 to 8>:UPPer:MARGin <numeric\_value>**

This command defines a margin to an upper limit line, at which out-of-limit values are signalled (if the limit check is active), but not handled as a violation of the limit value. The margin is independent of the measurement window.

Only the unit dB is available in *SPECTRUM* mode.

**Example:**           `"CALC:LIM2:UPP:MARG 10dB"`           'Defines the margin of limit line 2 to 10 dB 'below the limit value.

**Characteristics:** \*RST value:   0  
                       SCPI:           device-specific

**Mode:**            R, A

**CALCulate<1|2>:LIMit<1 to 8>:UPPer:MODE** RELative | ABSolute

This command selects the relative or absolute scaling for the Y-axis of the selected upper limit line. The setting is independent of the measurement window.

Selecting RELative causes the unit to be switched to DB.

**Example:** "CALC:LIM2:UPP:MODE REL" 'Defines the Y-axis of limit line 2 as relative scaled.

**Characteristics:** \*RST value: ABSolute  
SCPI: device-specific

**Mode:** A

**CALCulate<1|2>:LIMit<1 to 8>:UPPer:SHIFt** <numeric\_value>

This command moves a limit line by the indicated value in Y-direction. In contrast to CALC:LIM:UPP:OFFS, the line is shifted by modifying the individual Y values and not by means of an additive offset. The shift is independent of the measurement window.

Only the unit dB is available in the spectrum analysis mode.

**Example:** "CALC:LIM3:UPP:SHIF 20DB" 'Shifts all Y values of limit line 3 by 20 dB.

**Characteristics:** \*RST value: --  
SCPI: device-specific

**Mode:** R, A

This command is an event and is therefore not assigned an \*RST value and has no query.

**CALCulate<1|2>:LIMit<1 to 8>:UPPer:SPACing** LINear | LOGarithmic

This command selects linear or logarithmic interpolation for the upper limit line.

**Example:** "CALC:LIM:UPP:SPAC LIN"

**Features:** \*RST value: LIN  
SCPI: device-specific

**Modes:** R, A

**CALCulate<1|2>:LIMit<1 to 8>:UPPer:THReshold** <numeric\_value>

This command defines an absolute threshold value for limit lines with relative Y-axis scaling independently of the measurement window. The absolute threshold value is used in the limit check as soon as it exceeds the relative limit value.

The unit must correspond to the unit selected with CALC:LIM:UNIT (except dB which is not possible). If no unit is indicated, the unit defined with CALC:LIM:UNIT is automatically used (exception: dBm instead of dB).

**Example:** "CALC:LIM2:UPP:THR -35DBM" 'Defines an absolute threshold value for limit line 2.

**Characteristics:** \*RST value: -200 dBm  
SCPI: device-specific

**Mode:** A

## CALCulate:MARKer Subsystem

The CALCulate:MARKer subsystem checks the marker functions in the instrument. The measurement windows are assigned to CALCulate 1 (screen A) or 2 (screen B).

COMMAND	PARAMETERS	UNIT	COMMENT
CALCulate<1 2>			
:MARKer<1 to 4>			
[:STATe]	<Boolean>	--	
:AOFF			no query
:TRACe	<numeric_value>	--	
:X	<numeric_value>	HZ   S   DBM   DB	
:SLIMits			
[:STATe]	<Boolean>		
:LEFT	<numeric_value>	HZ   S	
:RIGHT	<numeric_value>	HZ   S	
:COUNt	<Boolean>	--	
:RESolution	<numeric_value>	HZ	
:FREQuency?	--	--	query only
:COUPled			
[:STATe]	<Boolean>		
:SCOupled			
[:STATe]	<Boolean>		
:LOEXclude	<Boolean>		
:Y?	--	--	query only
:PERCent	<numeric_value>	PCT	
:MAXimum		--	
[:PEAK]	--	--	no query
:NEXT	--	--	no query
:RIGHT	--	--	no query
:LEFT	--	--	no query
:MINimum			
[:PEAK]	--	--	no query
:NEXT	--	--	no query
:RIGHT	--	--	no query
:LEFT	--	--	no query
:PEXCursion	<numeric_value>	DB	

### CALCulate<1|2>:MARKer<1 to 4>[:STATe] ON | OFF

This command switches on or off the currently selected marker in the selected measurement window. If no indication is made, marker 1 is selected automatically. If marker 2, 3 or 4 is selected and used as a delta marker, it is switched to marker mode.

**Example:** "CALC:MARK3 ON" 'Switches marker 3 in screen A on or to marker mode.

**Characteristics:** \*RST value: OFF  
SCPI: device-specific

**Mode:** R, A

**CALCulate<1|2>:MARKer<1 to 4>:AOFF**

This command switches off all active markers in the selected measurement window. All delta markers and active marker/delta marker measurement functions are switched off.

**Example:** "CALC:MARK:AOFF" 'Switches off all markers in screen A.

**Characteristics:** \*RST value: -  
SCPI: device-specific

**Mode:** R, A

This command is an event and is therefore not assigned an \*RST value and has no query.

**CALCulate<1|2>:MARKer<1 to 4>:TRACe 1 to 3**

This command assigns the selected marker (1 to 4) to the indicated measurement curve in the selected measurement window. The corresponding trace must be active, ie its status must be different from "BLANK".

If necessary the corresponding marker is switched on prior to the assignment.

**Example:** "CALC:MARK3:TRAC 2" 'Assigns marker 3 in screen A to trace 2.

"CALC2:MARK:TRAC 3" 'Assigns marker 1 in screen B to trace 3.

**Characteristics:** \*RST value -  
SCPI: device-specific

**Mode:** R, A

**CALCulate<1|2>:MARKer<1 to 4>:X 0 to MAX (frequency | sweep time)**

This command positions the selected marker to the indicated frequency (span > 0), time (span = 0) or level (APD measurement or CCDF measurement ON) in the selected measurement window. If marker 2, 3 or 4 is selected and used as delta marker, it is switched to marker mode.

Available units: receiver: Hz; analyzer: HZ

**Example:** "CALC1:MARK2:X 10.7MHz" 'Positions marker 2 in screen A to frequency '10.7 MHz.

**Characteristics:** \*RST value: -  
SCPI: device-specific

**Mode:** R, A

**CALCulate<1|2>:MARKer<1 to 4>:X:SLIMits[:STATe] ON | OFF**

This command switches between a limited (ON) and unlimited (OFF) search range in the selected measurement window. The function is independent of the selection of a marker, ie the numeric suffix MARKer<1 to 4> is irrelevant.

If the time domain power measurement is active, this command limits the evaluation range on the trace.

**Example:** "CALC:MARK:X:SLIM ON" 'Switches on search limitation in screen A.

**Characteristics:** \*RST value: OFF  
SCPI: device-specific

**Mode:** R, A

**CALCulate<1|2>:MARKer<1 to 4>:X:SLIMits:LEFT** 0 to MAX (frequency | sweep time)

This command sets the left limit of the search range for markers and delta markers in the selected measurement window. Depending on the x-axis domain the indicated value defines a frequency (span > 0) or time (span = 0). The function is independent of the selection of a marker, ie the numeric suffix in MARKer<1 to 4> is irrelevant.

If the time domain power measurement is active, this command limits the evaluation range to the trace.

Available units: receiver: Hz; analyzer: HZ

**Note:** *The function is only available if the search limit for marker and delta marker is switched on (CALC:MARK:X:SLIM ON).*

**Example:**

"CALC:MARK:X:SLIM ON"	'Switches the search limit function on for screen A.
"CALC:MARK:X:SLIM:LEFT 10MHz"	'Sets the left limit of the search range in screen A to 10 MHz.

**Characteristics:** \*RST value: - (is set to the left diagram border on switching on search limits)  
SCPI: device-specific

**Mode:** R, A

**CALCulate<1|2>:MARKer<1 to 4>:X:SLIMits:RIGHT** 0 to MAX (frequency | sweep time)

This command sets the right limit of the search range for markers and delta markers in the selected measurement window. Depending on the x-axis domain the indicated value defines a frequency (span > 0) or time (span = 0). The function is independent of the selection of a marker, ie the numeric suffix in MARKer<1 to 4> is irrelevant.

If the time domain power measurement is active, this command limits the evaluation range to the trace.

**Note:**  
*The function is only available if the search limit for marker and delta marker is switched on (CALC:MARK:X:SLIM ON).*

**Example:**

"CALC:MARK:X:SLIM ON"	'Switches the search limit function on for screen A.
"CALC:MARK:X:SLIM:RIGHT 20MHz"	'Sets the right limit of the search range in screen A to 20 MHz.

**Characteristics:** \*RST value: - is set to the right diagram border on switching on search limits)  
SCPI: device-specific

**Mode:** R, A



**CALCulate<1|2>:MARKer<1 to 4>:COUNT ON | OFF**

This command switches on or off the frequency counter at the marker position in the selected measurement window. The count result is queried with `CALCulate:MARKer:COUNT:FREQUENCY?`.

Frequency counting is possible only for one marker at a time for each measurement window. If it is activated for another marker, it is automatically de-activated for the previous marker.

It should be noted that a complete sweep must be performed after switching on the frequency counter to ensure that the frequency to be measured is actually reached. The synchronization to the sweep end required for this is possible only in single-sweep mode.

**Example:**

"INIT:CONT OFF"	'Switches to single-sweep mode.
"CALC:MARK ON"	'Switches on marker 1 in screen A.
"CALC:MARK:COUN ON"	'Switches on the frequency counter for marker 1.
"INIT;*WAI"	'Starts a sweep and waits for the end.
"CALC:MARK:COUN:FREQ?"	'Outputs the measured value in screen A.

**Characteristics:** \*RST value: OFF  
SCPI: device-specific

**Mode:** A

**CALCulate<1|2>:MARKer<1 to 4>:COUNT:RESolution 0.1 | 1 | 10 | 100 | 1000 | 10000 Hz**

This command specifies the resolution of the frequency counter in the selected measurement window. The setting is independent of the selected marker, ie the numeric suffix in `MARKer<1 to 4>` is irrelevant.

**Example:**

"CALC:MARK:COUN:RES 1kHz"	'Sets the resolution of the frequency counter to 1 kHz.
---------------------------	---

**Characteristics:** \*RST value: 1kHz  
SCPI: device-specific

**Mode:** A

**CALCulate<1|2>:MARKer<1 to 4>:COUNT:FREQUENCY?**

This command queries the result of the frequency counter for the indicated marker in the selected measurement window. Before the command, the frequency counter should be switched on and a complete measurement performed to obtain a valid count result. Therefore, a single sweep with synchronization must be performed between switching on the frequency counter and querying the count result.

**Example:**

"INIT:CONT OFF"	'Switches to single-sweep mode.
"CALC:MARK2 ON"	'Switches marker 2 in screen A.
"CALC:MARK2:COUN ON"	'Switches the frequency counter for marker 2.
"INIT;*WAI"	'Starts a sweep and waits for the end.
"CALC:MARK2:COUN:FREQ?"	'Outputs the measured value of delta marker 2 in screen A.

**Characteristics:** \*RST value: -  
SCPI: device-specific

**Mode:** A

This command is only a query and thus has no \*RST value.

**CALCulate<1|2>:MARKer<1 to 4>:COUPled[:STATe] ON | OFF**

This command switches the coupling of the receiver frequency to the marker on or off. The numeric suffix in MARKer<1 to 4> is irrelevant.

**Example:** "CALC:MARK:COUP ON" marker coupling is switched on  
**Characteristics:** \*RST value: OFF  
 SCPI: device-specific  
**Mode:** R

**CALCulate<1|2>:MARKer<1 to 4>:SCOupled[:STATe] ON | OFF**

This command switches the coupling of the receiver frequency at the marker frequency on or off. The numeric suffix in MARKer<1 to 4> is not significant.

**Example:** "CALC:MARK:SCO ON"  
**Features:** \*RST value: ON  
 SCPI: device-specific  
**Mode:** R

**CALCulate<1|2>:MARKer<1 to 4>:LOEXclude ON | OFF**

This command switches the local oscillator suppression for peak search on or off. This setting is valid for all markers and delta markers in all measurement windows. The numeric suffixes 1|2 and 1 to 4 are irrelevant.

**Example:** "CALC:MARK:LOEX ON"  
**Characteristics:** \*RST value: ON  
 SCPI: device-specific  
**Mode:** A-F

**CALCulate<1|2>:MARKer<1 to 4>:Y?**

This command queries the measured value of the selected marker in the selected measurement window. The corresponding marker is activated before or switched to marker mode, if necessary. To obtain a valid query result, a complete sweep with synchronization to the sweep end must be performed between the activation of the marker and the query of the y value. This is only possible in single sweep mode.

The query result is output in the unit determined with CALCulate:UNIT.

In the default setting, the output is made depending on the unit determined with CALC:UNIT; only with linear level scaling is the output in %.

**Example:** "INIT:CONT OFF" 'Switches to single-sweep mode.  
 "CALC:MARK2 ON" 'Switches marker 2 in screen A.  
 "INIT;\*WAI" 'Starts a sweep and waits for the end.  
 "CALC:MARK2:Y?" 'Outputs the measured value of marker 2 in screen A.  
**Characteristics:** \*RST value: -  
 SCPI: device-specific  
**Mode:** R, A

**CALCulate<1|2>:MARKer<1 to 4>:Y:PERCent 0 to100%**

This command positions the selected marker in the selected window to the given probability. If marker 2, 3 or 4 is selected and used as a delta marker, it is switched to marker mode.

**Note:** *The command is only available with the CCDF measurement switched on.  
The associated level value can be determined with the CALC:MARK:X? command.*

**Example:** "CALC1:MARK:Y:PERC 95PCT" 'Positions marker 1 in screen A to a  
'probability of 95%.

**Characteristics:** \*RST value: -  
SCPI: device-specific

**Mode:** A

**CALCulate<1|2>:MARKer<1 to 4>:MAXimum[:PEAK]**

This command positions the marker to the current maximum value of the corresponding trace in the selected measurement window. The corresponding marker is activated first or switched to the marker mode.

**Note:** *If no maximum value is found on the trace (level spacing to adjacent values < peak excursion), an execution error (error code: -200) is produced.*

**Example:** "CALC:MARK2:MAX" 'Positions marker 2 in screen A to the maximum value of  
'the trace.

**Characteristics:** \*RST value: -  
SCPI: device-specific

**Mode:** R, A

This command is an event and is therefore not assigned an \*RST value and has no query.

**CALCulate<1|2>:MARKer<1 to 4>:MAXimum:NEXT**

This command positions the marker to the next smaller maximum value of the corresponding trace in the selected measurement window.

**Note:** *If no next smaller maximum value is found on the trace (level spacing to adjacent values < peak excursion), an execution error (error code: -200) is produced.*

**Example:** "CALC:MARK2:MAX:NEXT" 'Positions marker 2 in screen A to the next  
'lower maximum value.

**Characteristics:** \*RST value: -  
SCPI: device-specific

**Mode:** R, A

This command is an event and is therefore not assigned an \*RST value and has no query.

**CALCulate<1|2>:MARKer<1 to 4>:MAXimum:RIGHT**

This command positions the marker to the next smaller maximum value to the right of the current value (ie in ascending X values) on the corresponding trace in the selected measurement window.

**Note:** *If no next smaller maximum value is found on the trace (level spacing to adjacent values < peak excursion), an execution error (error code: -200) is produced.*

**Example:** "CALC:MARK2:MAX:RIGH" 'Positions marker 2 in screen A to the next  
'lower maximum value to the right of the  
'current value.

**Characteristics:** \*RST value: -  
SCPI: device-specific

**Mode:** R, A

This command is an event and is therefore not assigned an \*RST value and has no query.

**CALCulate<1|2>:MARKer<1 to 4>:MAXimum:LEFT**

This command positions the marker to the next smaller maximum value to the left of the current value (ie in descending X values) on the trace in the selected measurement window.

**Note:** *If no next smaller maximum value is found on the trace (level spacing to adjacent values < peak excursion), an execution error (error code: -200) is produced.*

**Example:** "CALC:MARK2:MAX:LEFT" 'Positions marker 2 in screen A to the next  
'lower maximum value to the left of the current  
'value.

**Characteristics:** \*RST value: -  
SCPI: device-specific

**Mode:** R, A

This command is an event and is therefore not assigned an \*RST value and has no query.

**CALCulate<1|2>:MARKer<1 to 4>:MINimum[:PEAK]**

This command positions the marker to the current minimum value of the corresponding trace in the selected measurement window. The corresponding marker is activated first or switched to marker mode, if necessary.

**Note:** *If no minimum value is found on the trace (level spacing to adjacent values < peak excursion), an execution error (error code: -200) is produced.*

**Example:** "CALC:MARK2:MIN" 'Positions marker 2 in screen A to the minimum value of  
'the trace.

**Characteristics:** \*RST value: -  
SCPI: device-specific

**Mode:** R, A

This command is an event and is therefore not assigned an \*RST value and has no query.

**CALCulate<1|2>:MARKer<1 to 4>:MINimum:NEXT**

This command positions the marker to the next higher minimum value of the corresponding trace in the selected measurement window.

**Note:** *If no next higher minimum value is found on the trace (level spacing to adjacent values < peak excursion), an execution error (error code: -200) is produced.*

**Example:** "CALC:MARK2:MIN:NEXT" 'Positions marker 2 in screen A to the next  
'higher maximum value.

**Characteristics:** \*RST value: -  
SCPI: device-specific

**Mode:** R, A

This command is an event and is therefore not assigned an \*RST value and has no query.

**CALCulate<1|2>:MARKer<1 to 4>:MINimum:RIGHT**

This command positions the marker to the next higher minimum value to the right of the current value (ie in ascending X direction) on the corresponding trace in the selected measurement window.

**Note:** *If no next higher minimum value is found on the trace (level spacing to adjacent values < peak excursion), an execution error (error code: -200) is produced.*

**Example:** "CALC:MARK2:MIN:RIGHT" 'Positions marker 2 in screen A to the next  
'higher minimum value to the right of the  
'current value.

**Characteristics:** \*RST value: -  
SCPI: device-specific

**Mode:** R, A

This command is an event and is therefore not assigned an \*RST value and has no query.

**CALCulate<1|2>:MARKer<1 to 4>:MINimum:LEFT**

This command positions the marker to the next higher minimum value to the left of the current value (ie in descending X direction) on the corresponding trace in the selected measurement window.

**Note:** *If no next higher minimum value is found on the trace (level spacing to adjacent values < peak excursion), an execution error (error code: -200) is produced.*

**Example:** "CALC:MARK2:MIN:LEFT" 'Positions marker 2 in screen A to the next  
'higher minimum value to the left of the  
'current value.

**Characteristics:** \*RST value: -  
SCPI: device-specific

**Mode:** R, A

This command is an event and is therefore not assigned an \*RST value and has no query.

**CALCulate<1|2>:MARKer<1 to 4>:PEXCursion <numeric\_value>**

This command defines the peak excursion., ie the spacing below a trace maximum which must be attained before a new maximum is recognized, or the spacing above a trace minimum which must be attained before a new minimum is recognized. The set value is valid for all markers and delta markers. The unit depends on the selected operating mode.

**Example:** "CALC:MARK:PEXC 10dB" 'Defines peak excursion 10 dB in  
'SPECTRUM mode

**Characteristics:** \*RST value: 6dB  
SCPI: device-specific

**Mode:** R, A

The numeric suffix in MARKer<1 to 4> is irrelevant.

## CALCulate:MARKer:FUNction Subsystem

The measurement window is selected by CALCulate 1 (screen A) or 2 (screen B).

COMMAND	PARAMETERS	UNIT	COMMENT
CALCulate<1 2> :MARKer<1 to 4> :FUNction :NDBDown :STATe :RESult? :FREQuency? :ZOOM :NOISe [:STATe] :RESult? :DEModulation :SElect [:STATe] :HOLDoff :CONTinuous :MDEPth [:STATe] :RESult? :TOI [:STATe] :RESult? :CENTer :CSTep :REFerence	<numeric_value> <Boolean> -- -- <numeric_value> -- <Boolean> -- AM FM <Boolean> <numeric_value> <Boolean> -- <Boolean> -- <Boolean> --	DB -- -- HZ -- S -- --	query only query only no query query only query only query only no query no query no query

### CALCulate<1|2>:MARKer<1 to 4>:FUNction:NDBDown <numeric\_value>

This command defines the level spacing of the two delta markers to the right and left of marker 1 in the selected measurement window. Marker 1 is always used as the reference marker. The numeric suffix <1 to 4> is irrelevant for this command.

The temporary markers T1 and T2 are positioned by n dB below the active reference marker. The frequency spacing of these markers can be queried with CALCulate:MARKer:FUNction:NDBDown:RESult?.

**Example:** "CALC:MARK:FUNC:NDBD 3dB" 'Sets the level spacing in screen A to 3 dB.

**Characteristics:** \*RST value: 6dB  
SCPI: device-specific

**Mode:** A

### CALCulate<1|2>:MARKer<1 to 4>:FUNction:NDBDown:STATe ON | OFF

This command switches the "N dB Down" function on or off in the selected measurement window. Marker 1 is activated first, if necessary. The numeric suffix <1 to 4> is irrelevant for this command.

**Example:** "CALC:MARK:FUNC:NDBD:STAT ON" 'Switches on the N-dB-down function in screen A.

**Characteristics:** \*RST value: OFF  
SCPI: device-specific

**Mode:** A

**CALCulate<1|2>:MARKer<1 to 4>:FUNCtion:NDBDown:RESult?**

This command queries the frequency spacing (bandwidth) of the N-dB-down markers in the selected measurement window. The numeric suffix <1 to 4> is irrelevant for this command.

A complete sweep with synchronization to sweep end must be performed between switching on the function and querying the measured value in order to obtain a valid query result. This is only possible in single sweep mode.

**Example:**

"INIT:CONT OFF"	'Switches to single-sweep mode.
"CALC:MARK:FUNC:NDBD ON"	'Switches on the n-dB-down function in screen A.
"INIT;*WAI"	'Starts a sweep and waits for the end.
"CALC:MARK:FUNC:NDBD:RES?"	'Outputs the measured value of screen A.

**Characteristics:** \*RST value: -  
SCPI: device-specific

**Mode:** A

This command is only a query and is therefore not assigned an \*RST value.

**CALCulate<1|2>:MARKer<1 to 4>:FUNCtion:NDBDown:FREQuency?**

This command queries the two frequencies of the N-dB-down marker in the selected measurement window. The numeric suffix <1 to 4> is irrelevant for this command. The two frequency values are separated by comma and output in ascending order.

A complete sweep with synchronization to sweep end must be performed between switching on the function and querying the measured value to obtain a valid query result. This is only possible in single sweep mode.

**Example:**

"INIT:CONT OFF"	'Switches to single-sweep mode.
"CALC:MARK:FUNC:NDBD ON"	'Switches on the n-dB-down function in screen A.
"INIT;*WAI"	'Starts a sweep and waits for the end.
"CALC:MARK:FUNC:NDBD:FREQ?"	'Outputs the frequencies of the temporary markers in screen A.

**Characteristics:** \*RST value: -  
SCPI: device-specific

**Mode:** A

This command is only a query and is therefore not assigned an \*RST value.

**CALCulate<1|2>:MARKer<1 to 4>:FUNCtion:ZOOM <numeric\_value>**

This command defines the range to be zoomed around marker 1 in the selected measurement window. Marker 1 is activated first, if necessary.

The subsequent frequency sweep is stopped at the marker position and the frequency of the signal is counted. This frequency becomes the new center frequency, and the zoomed span is set. In order to recognize the end of the operation the synchronization to the sweep end should be activated. This is only possible in single sweep mode.

**Example:**

"INIT:CONT OFF"	'Switches to single-sweep mode
"CALC:MARK:FUNC:ZOOM 1kHz;*WAI"	'Activates zooming in screen A and waits for its end.

**Characteristics:** \*RST value: -  
SCPI: device-specific

**Mode:** R, A-F

This command is an event and is therefore not assigned an \*RST value and has no query.

**CALCulate<1|2>:MARKer<1 to 4>:FUNCTION:NOISe[:STATe] ON | OFF**

This command switches the noise measurement on or off for all markers of the indicated measurement window. The noise power density is measured at the position of the markers. The result can be queried with `CALCulate:MARKer:FUNCTION:NOISe:RESult?`.

**Example:**           `"CALC2:MARK:FUNC:NOIS ON"` 'Switches on the noise measurement for 'screen B.

**Characteristics:** \*RST value:   OFF  
SCPI:               device-specific

**Mode:**            A

**CALCulate<1|2>:MARKer<1 to 4>:FUNCTION:NOISe:RESult?**

This command queries the result of the noise measurement.

A complete sweep with synchronization to the sweep end must be performed between switching on the function and querying the measured value in order to obtain a valid query result. This is only possible in single sweep mode.

**Example:**           `"INIT:CONT OFF"`                       'Switches to single-sweep mode.  
                  `"CALC:MARK2 ON"`                         'Switches on marker 2 in screen A.  
                  `"CALC:MARK:FUNC:NOIS ON"`               'Switches on noise measurement in screen A.  
                  `"INIT;*WAI"`                             'Starts a sweep and waits for the end.  
                  `"CALC:MARK2:NOIS:RES?"`                'Outputs the noise result of marker 2 in 'screen A.

**Characteristics:** \*RST value:   -  
SCPI:               device-specific

**Mode:**            A

This command is an event and is therefore not assigned an \*RST value and has no query.

**CALCulate<1|2>:MARKer<1 to 4>:FUNCTION:DEModulation:SElect AM | FM**

This command selects the demodulation type for the audio demodulator. The command is independent of the measurement window and of the selected marker, ie suffixes 1|2 and 1 to 4 are irrelevant.

**Example:**           `"CALC:MARK:FUNC:DEM:SEL FM"`

**Characteristics:** \*RST value:   AM  
SCPI:               device-specific

**Mode:**            A

**CALCulate<1|2>:MARKer<1 to 4>:FUNCTION:DEModulation[:STATe] ON | OFF**

This command switches on or off the audio demodulator when the indicated marker is reached in the selected measurement window. In the frequency domain (span > 0) the hold time can be defined at the corresponding marker position with `CALCulate:MARKer:FUNCTION:DEModulation:HOLD`. In the time domain (span = 0) the demodulation is permanently active.

**Example:**           `"CALC2:MARK3:FUNC:DEM ON"` 'Switches on the demodulation for marker 3 in 'screen B.

**Characteristics:** \*RST value:   OFF  
SCPI:               device-specific

**Mode:**            A



**CALCulate<1|2>:MARKer<1 to 4>:FUNCtion:DEModulation:HOLDoff** 10ms to 1000s

This command defines the hold time at the marker position for the demodulation in the frequency domain (span > 0). The setting is independent of the measurement window and the selected marker, ie the suffixes <1|2> and <1 to 4> are irrelevant

**Example:** "CALC:MARK:FUNC:DEM:HOLD 3s"

**Characteristics:** \*RST value: - (DEModulation is set to OFF)  
SCPI: device-specific

**Mode:** A

**CALCulate<1|2>:MARKer<1 to 4>:FUNCtion:DEModulation:CONTinuous ON | OFF**

This command switches on or off the continuous demodulation in the frequency domain (span >0) in the selected measurement window. Thus acoustic monitoring of the signals can be performed in the frequency domain. The function does not depend on the selected marker, ie the numeric suffix <1 to 4> is irrelevant.

**Example:** "CALC2:MARK3:FUNC:DEM:CONT ON" 'Switches on the continuous demodulation in screen B.

**Characteristics:** \*RST value: OFF  
SCPI: device-specific

**Mode:** A

**CALCulate<1|2>:MARKer<1 to 4>:FUNCtion:MDEPth:[:STATe]**

This command switches on the measurement of the AM modulation depth. An AM-modulated carrier is required on the screen for correct operation. If necessary, marker 1 is previously activated and set to the largest signal available.

The level value of marker 1 is regarded as the carrier level. On activating the function, marker 2 and marker 3 are automatically set as delta markers symmetrically to the carrier to the adjacent maxima of the trace.

If the position of delta marker 2 is changed, delta marker 3 is moved symmetrically with respect to the reference marker (marker 1). If the position of delta marker 3 is changed, fine adjustment can be performed independently of delta marker 2.

The ESPI calculates the power at the marker positions from the measured levels.

The AM modulation depth is calculated from the ratio of power values at the reference marker and the delta markers. If the two AM sidebands differ in power, the average value of the two power values is used for calculating the AM modulation depth.

The numeric suffix <1 to 4> of :MARKer is irrelevant with this command.

**Example:** "CALC:MARK:X 10MHZ" 'Sets the reference marker (marker 1) to the carrier signal at 10 MHz  
"CALC:MARK:FUNC:MDEP ON" 'Switches on the modulation depth measurement in screen A.  
"CALC:DELT2:X 10KHZ" 'Sets delta markers 2 and 3 to the signals at 10 kHz from the carrier signal  
"CALC:DELT3:X 9.999KHZ" 'Corrects the position of delta marker 3 relative to delta marker 2.

**Characteristics:** \*RST value: OFF  
SCPI: device-specific

**Mode:** A

**CALCulate<1|2>:MARKer<1 to 4>:FUNCtion:MDEPth:RESult?**

This command queries the AM modulation depth in the indicated measurement window.

A complete sweep with synchronization to sweep end must be performed between switching on the function and querying the measured value to obtain a valid query result. This is only possible in single sweep mode.

The numeric suffix <1 to 4> of :MARKer is irrelevant for this command.

<b>Example:</b>	"INIT:CONT OFF"	'Switches to single-sweep mode.
	"CALC:MARK:X 10MHZ"	'Sets the reference marker (marker 1) to the carrier signal at 10 MHz.
	"CALC:MARK:FUNC:MDEP ON"	'Switches on the modulation depth measurement in screen A.
	"INIT;*WAI"	'Starts a sweep and waits for the end.
	"CALC:MARK:FUNC:MDEP:RES?"	'Outputs the measured value of screen A.

**Characteristics:** \*RST value: -  
SCPI: device-specific

**Mode:** A

This command is only a query and thus has no \*RST value assigned.

**CALCulate<1|2>:MARKer<1 to 4>:FUNCtion:TOI[:STATe] ON | OFF**

This command initiates the measurement of the third-order intercept point.

A two-tone signal with equal carrier levels is expected at the RF input of the instrument. Marker 1 and marker 2 (both normal markers) are set to the maximum of the two signals. Delta marker 3 and delta marker 4 are positioned to the intermodulation products. The delta markers can be modified separately afterwards with the commands CALCulate:DELTamarker3:X and CALCulate:DELTamarker4:X.

The third-order intercept is calculated from the level spacing between the normal markers and the delta markers.

The numeric suffix <1 to 4> of :MARKer is irrelevant for this command.

<b>Example:</b>	"CALC:MARK:FUNC:TOI ON"	'Switches on the measurement of the third-order intercept in screen A.
-----------------	-------------------------	--

**Characteristics:** \*RST value: OFF  
SCPI: device-specific

**Mode:** A

**CALCulate<1|2>:MARKer<1 to 4>:FUNCtion:TOI:RESult?**

This command queries the third-order intercept point measurement in the indicated measurement window.

A complete sweep with synchronization to sweep end must be performed between switching on the function and querying the measured value to obtain a valid query result. This is only possible in single sweep mode.

The numeric suffix <1 to 4> of :MARKer is irrelevant of this command.

<b>Example:</b>	"INIT:CONT OFF"	'Switches to single-sweep mode.
	"CALC:MARK:FUNC:TOI ON"	'Switches the intercept measurement in 'screen A.
	"INIT;*WAI"	'Starts a sweep and waits for the end.
	"CALC:MARK:FUNC:TOI:RES?"	'Outputs the measured value of screen A.

**Characteristics:** \*RST value: -  
SCPI: device-specific

**Mode:** A

This command is only a query and thus has no \*RST value assigned.

**CALCulate<1|2>:MARKer<1 to 4>:FUNCtion:CENTer**

This command sets the receiver or center frequency of the selected measurement window equal to the frequency of the indicated marker.

If marker 2, 3 or 4 is selected and used as delta marker, it is switched to the marker mode.

<b>Example:</b>	"CALC:MARK2:FUNC:CENT"	'Sets the receiver frequency to the frequency of 'marker 2.
-----------------	------------------------	--

**Characteristics:** \*RST value: -  
SCPI: device-specific

**Mode:** R, A-F

This command is an "event" and therefore has no \*RST value assigned and has no query.

**CALCulate<1|2>:MARKer<1 to 4>:FUNCtion:CSTep**

This command sets the step width of the receiver or center frequency in the selected measurement window to the X value of the current marker. If marker 2, 3 or 4 is selected and used as delta marker, it is switched to the marker mode.

<b>Example:</b>	"CALC2:MARK2:FUNC:CST"	'Sets the receiver frequency to the same value 'as the frequency of marker 2.
-----------------	------------------------	--

**Characteristics:** \*RST value: -  
SCPI: device-specific

**Mode:** A-F

This command is an event and therefore has no \*RST value assigned and has no query.

**CALCulate<1|2>:MARKer<1 to 4>:FUNCtion:REFerence**

This command sets the reference level in the selected measurement window to the power measured by the indicated marker. If marker 2, 3 or 4 is selected and used as delta marker, it is switched to marker mode.

**Example:** "CALC:MARK2:FUNC:REF" 'Sets the reference level of screen A to the the 'level of marker 2.

**Characteristics:** \*RST value: -  
SCPI: device-specific

**Mode:** A

This command is an event and therefore has no \*RST value assigned and has no query.

**CALCulate:MARKer:FUNction:POWer Subsystem**

The CALCulate:MARKer:FUNction:POWer subsystem contains the commands for control of power measurement.

COMMAND	PARAMETERS	UNIT	COMMENT
CALCulate<1 2> :MARKer :FUNction :POWer :SElect :RESult? :PHZ :PRESet  [:STATe]	ACPower   CPOWer   OBANdwidth   OBWidth CN   CN0  ACPower   CPOWer   OBANdwidth   OBWidth   CN   CN0  <Boolean> NADC   TETRA   PDC   PHS   CDPD   FWCDma   RWCDma   F8CDma   R8CDma   F19Cdma   R19Cdma   FW3Gppcdma   RW3Gppcdma   D2CDma   S2CDma   M2CDma   FIS95A   RIS95A   FIS95C0   RIS95C0   FIS95C1   RIS95C1   FJ008   RJ008   NONE OFF		query only       no query

**CALCulate<1|2>:MARKer<1 to 4>:FUNction:POWer:SElect** ACPower | CPOWer | OBANdwidth | OBWidth | CN | CN0

This command selects the indicated power measurement and switches it on in the selected measurement window.. The function is independent of the selected marker, ie the numeric suffix <1 to 4> of MARKer is irrelevant.

The configuration of channel spacings and channel bandwidths is performed by means of subsystem SENSE:POWer:ACHannel.

It should be noted that selecting CPOWer causes the number of adjacent channels (command: [SENSe<1|2>:]POWer:ACHannel:ACPairs) to be set to 0. Selecting ACPower causes the number of adjacent channels to be set to 1, if the adjacent channel power measurement is not yet switched on.

In both cases the behaviour of ESPI differs from that of the ESIB family.

**Notes:** *The measurement of the channel/adjacent channel power is performed on the trace which has been selected with SENSE:POWer:TRACe 1|2|3.*

The measurement of the occupied bandwidth is performed on the trace on which marker 1 is positioned. In order to evaluate another trace, marker 1 should be positioned on another trace with CALC:MARK:TRAC 1|2|3.

<b>Parameter:</b>	ACPower	adjacent channel power measurement
	CPOWer	channel power measurement (same as adjacent channel power measurement with No. of Adj Channels = 0)
	OBANdwidth   OBWidth	occupied bandwidth power measurement
	CN	signal / noise power measurement
	CN0	signal- / noise power measurement based on 1Hz bandwidth

**Example:** "CALC:MARK:FUNC:POW:SEL ACP" 'Switches on the adjacent channel power measurement in screen A.

**Characteristics:** \*RST value: -  
SCPI: device-specific

**Mode:** A-F

**CALCulate<1|2>:MARKer<1 to 4>:FUNCTION:POWER:RESult?ACPower | CPOWer | OBANdwidth | OBWidth | CN | CNO**

This command queries the results of the power measurement in the selected measurement window. The measurement is switched on first, if necessary.

The configuration of channel spacings and channel bandwidths is performed with subsystem `SENSe:POWer:ACHannel`.

To obtain a valid result, a complete sweep with synchronization to the sweep end must be performed before the query is executed. This is possible in single sweep mode only.

**Parameter:**

**ACPower:** adjacent channel power measurement

Results are output separated by commas in the following order:

1. Power of main channel
2. Power of lower adjacent channel
3. Power of upper adjacent channel
4. Power of lower alternate adjacent channel 1
5. Power of upper alternate adjacent channel 1
6. Power of lower alternate adjacent channel 2
7. Power of upper alternate adjacent channel 2

The number of results depends on the number of adjacent channels selected with command `SENSe:POWer:ACHannel:ACPairs`.

With logarithmic scaling (RANGE LOG), the power is output in dBm, with linear scaling (RANGE LIN dB or LIN %) in W. If `SENSe:POWer:ACHannel:MODE REL` is selected, adjacent channel power is output in dB.

**CPOWer** channel power measurement

With logarithmic scaling (RANGE LOG), the channel power is output in dBm, with linear scaling (RANGE LIN dB or LIN %) in W.

**OBANdwidth | OBWidth** occupied bandwidth power measurement

The return value is the occupied bandwidth in Hz.

**CN** signal / noise power measurement  
The return value is always in dB.

**CNO** signal noise power measurement based on 1Hz bandwidth  
The return value is always in dB/Hz

**Example of channel/adjacent power measurement:**

<code>"SENS2:POW:ACH:ACP 3"</code>	'Sets the number of adjacent channels in 'screen B to 3.
<code>"SENS2:POW:ACH:BAND 30KHZ"</code>	'Sets the bandwidth of the main channel to '30 kHz.
<code>"SENS2:POW:ACH:BAND:ACH 40KHZ"</code>	'Sets the bandwidth of all adjacent 'channels to 40 kHz.
<code>"SENS2:POW:ACH:BAND:ALT1 50KHZ"</code>	'Sets the bandwidth of all alternate 'adjacent channels to 50 kHz.
<code>"SENS2:POW:ACH:BAND:ALT2 60KHZ"</code>	'Sets the bandwidth of alternate adjacent 'channel 2 to 60 kHz.
<code>"SENS2:POW:ACH:SPAC 30KHZ"</code>	'Sets the spacing between channel to 'adjacent channel to 30 kHz as well as 'between channel and alternate adjacent 'channel to 60 kHz and 2nd alternate 'adjacent channel to 90 kHz.

"SENS2:POW:ACH:MODE ABS"	'Switches on the measurement of absolute power values.
"CALC2:MARK:FUNC:POW:SEL ACP"	'Switches the adjacent channel power measurement in screen B.
"INIT:CONT OFF"	'Switches to single-sweep mode.
"INIT;*WAI"	'Starts a sweep and waits for the end
"CALC2:MARK:FUNC:POW:RES? ACP"	'Queries the result of the adjacent channel power measurement in screen B.
	'In case of relative measurement, the measured channel power can be defined as the reference power with command.
"SENS2:POW:ACH:REF:AUTO ONCE".	

If only the **channel power** is to be measured, all commands for defining the bandwidths of adjacent channels as well as the channel spacings are not necessary. The number of adjacent channels is set to 0 with SENS2:POW:ACH:ACP 0.

#### Example of occupied bandwidth measurement:

"SENS2:POW:BAND 90PCT"	'Sets the percentage of the power contained in the bandwidth under request to 90%.
"INIT:CONT OFF"	'Switches to single-sweep mode.
"INIT;*WAI"	'Starts a sweep and waits for the end.
"CALC2:MARK:FUNC:POW:RES? OBW"	'Queries the result of the occupied bandwidth in screen B.

**Characteristics:** \*RST value: -  
SCPI: device-specific

Mode: A-F

This command is only a query and is therefore not assigned an \*RST value.

**CALCulate<1|2>:MARKer<1 to 4>:FUNCtion:POWER:RESult:PHZ ON | OFF**

This command switches the query response of the power measurement results in the indicated measurement window between output of absolute values (OFF) and output referred to the measurement bandwidth (ON).

The measurement results are output with `CALCulate:MARKer:FUNCtion:POWER:RESult?`

**Parameter:**

- ON:** Results output referred to measurement bandwidth.  
**OFF:** Results output in absolute values.

**Example of channel/adjacent channel measurement:**

"SENS2:POW:ACH:ACP 3"	'Sets the number of adjacent channels in 'screen B to 3.
"SENS2:POW:ACH:BAND 30KHZ"	'Sets the bandwidth of the main channel to 30 kHz.
"SENS2:POW:ACH:BAND:ACH 40KHZ"	'Sets the bandwidth of all adjacent 'channels to 40 kHz.
"SENS2:POW:ACH:BAND:ALT1 50KHZ"	'Sets the bandwidth of all alternate 'adjacent channels to 50 kHz.
"SENS2:POW:ACH:BAND:ALT2 60KHZ"	'Sets the bandwidth of alternate adjacent 'channel 2 to 60 kHz.
"SENS2:POW:ACH:SPAC 30KHZ"	'Sets the spacing between channel and 'adjacent channel as well as between all 'adjacent channels to 30 kHz.
"SENS2:POW:ACH:SPAC:ALT1 40KHZ"	'Sets the spacing between adjacent 'channel and alternate adjacent channel as 'well as between all alternate adjacent 'channels to 40 kHz.
"SENS2:POW:ACH:SPAC:ALT2 50KHZ"	'Sets the spacing between alternate 'adjacent channel 1 and alternate adjacent 'channel 2 to 50 kHz.
"SENS2:POW:ACH:MODE ABS"	'Switches on absolute power 'measurement.
"CALC2:MARK:FUNC:POW:SEL ACP"	'Switches the adjacent channel power 'measurement in screen B.
"INIT:CONT OFF"	'Switches to single-sweep mode.
"INIT:*WAI"	'Starts a sweep and waits for the end.
"CALC2:MARK:FUNC:POW:RES:PHZ ON"	'Output of results referred to the channel 'bandwidth.
"CALC2:MARK:FUNC:POW:RES? ACP"	'Queries the result of the adjacent channel 'power measurement in screen B referred 'to the channel bandwidth.

If only the **channel power** is to be measured, all commands for defining the bandwidths of adjacent channels as well as the channel spacings are not necessary. The number of adjacent channels is set to 0 with `SENS2:POW:ACH:ACP 0`.

**Characteristics:** \*RST value: -  
SCPI: device-specific

**Mode:** A-F



**CALCulate<1|2>:MARKer<1 to 4>:FUNCtion:POWER[:STATe] OFF**

This command switches off the power measurement in the selected measurement window.

**Example:** "CALC:MARK:FUNC:POW OFF" 'Switches off the power measurement in screen B.

**Characteristics:** \*RST value: -  
SCPI: device-specific

**Mode:** A-F

This command is an event and is therefore not assigned an \*RST value.

**CALCulate<1|2>:MARKer<1 to 4>:FUNCtion:POWER:PRESet**

NADC | TETRA | PDC | PHS | CDPD | FWCDma | RWCDma | F8CDma | R8CDma | F19CDma |  
R19CDma | FW3Gppcdma | RW3Gppcdma | D2CDma | S2CDma | M2CDma | FIS95A | RIS95A |  
FIS95C0 | RIS95C0 | FJ008 | RJ008 | FIS95C1 | RIS95C1 | NONE

This command selects the power measurement setting for a standard in the indicated measurement window and previously switches on the corresponding measurement, if required. The function is independent of the marker selection, ie the numeric suffix <1 to 4> of MARKer is irrelevant.

The configuration for a standard comprises of the parameters weighting filter, channel bandwidth and spacing, resolution and video bandwidth, as well as detector and sweep time.

Meaning of the CDMA standard abbreviations:

FIS95A, F8CDma	CDMA IS95A forward
RIS95A, R8CDma	CDMA IS95A reverse
FJ008, F19CDma	CDMA J-STD008 forward
RJ008, R19CDma	CDMA J-STD008 reverse
FIS95C0	CDMA IS95C Class 0 forward
RIS95C0	CDMA IS95C Class 0 reverse
FIS95C1	CDMA IS95C Class 1 forward
RIS95C1	CDMA IS95C Class 1 reverse
FWCDma	W-CDMA 4.096 MHz forward
RWCDma	W-CDMA 4.096 MHz reverse
FW3Gppcdma	W-CDMA 3.84 MHz forward
RW3Gppcdma	W-CDMA 3.84 MHz reverse
D2CDma	CDMA 2000 direct sequence
S2CDma	CDMA 2000 MC1 multi carrier with 1 carrier
M2CDma	CDMA 2000 MC3 multi carrier with 3 carriers

**Notes:** *The settings for standards IS95A and C differ as far as the calculation method of channel spacings is concerned. For IS95A and J-STD008 the spacing is calculated from the center of the main channel to the center of the corresponding adjacent channel, for IS95C from the center of the main channel to the nearest border of the adjacent channel.*

**Example:** "CALC2:MARK:FUNC:POW:PRES NADC" 'Selects the standard setting for 'NADC in screen B

**Characteristics:** \*RST value: -  
SCPI: device-specific

**Mode:** A-F

## CALCulate:MARKer:FUNCTION:STRack Subsystem

The CALCulate:MARKer:FUNCTION:STRack subsystem defines the settings of the signal track.

COMMAND	PARAMETERS	UNIT	COMMENT
CALCulate<1 2> :MARKer :FUNCTION :STRack [:STATe] :BANDwidth :BWIDth :THReshold :TRACe	<Boolean> <numeric_value> <numeric_value> <numeric_value> <numeric_value>	 HZ HZ DBM	

### CALCulate<1|2>:MARKer<1 to 4>:FUNCTION:STRack[:STATe] ON | OFF

This command switches the signal-track function on or off for the the selected measurement window. The function is independent of the selected marker, ie the numeric suffix <1 to 4> of MARKer is irrelevant.

With signal track activated, the maximum signal is determined after each frequency sweep and the center frequency is set to the frequency of this signal. Thus with drifting signals the center frequency follows the signal.

**Example:** "CALC:MARK:FUNC:STR ON" 'Switches on the signal track function for 'screen A.

**Characteristics:** \*RST value: OFF  
SCPI: device-specific

**Mode:** A-F

### CALCulate<1|2>:MARKer<1 to 4>:FUNCTION:STRack:BANDwidth 10Hz to MAX (SPAN)

### CALCulate<1|2>:MARKer<1 to 4>:FUNCTION:STRack:BWIDth 10Hz to MAX (SPAN)

These commands have the same function. For the selected measurement window they define the bandwidth around the center frequency within which the largest signal is searched. The function is independent of the selected marker, ie the numeric suffix <1 to 4> of MARKer is irrelevant. It is only available in the frequency domain (span > 0).

**Note:** The entry of the search bandwidth is only possible if the Signal Track function is switched on (CALC:MARK:FUNC:STR ON).

**Example:** "CALC:MARK:FUNC:STR:BAND 1MHZ" 'Sets the search bandwidth for screen 'A to 1 MHz.

"CALC:MARK:FUNC:STR:BWID 1MHZ" 'Alternative command for the same 'function.

**Characteristics:** \*RST value: -- (= span/10 on activating the function)  
SCPI: device-specific

**Mode:** A-F

**CALCulate<1|2>:MARKer<1 to 4>:FUNCtion:STRack:THReshold** -330dBm to +30dBm

This command defines the threshold above which the largest signal is searched for in the selected measurement window. The function is independent of the selected marker, ie the numeric suffix <1 to 4> of MARKer is irrelevant. It is only available in the frequency domain (span > 0)..

The response unit depends on the settings defined with CALC:UNIT.

**Note:** *The entry of the search bandwidth is only possible if the Signal Track function is switched on (CALC:MARK:FUNC:STR ON).*

**Example:** "CALC:MARK:FUNC:STR:THR -50DBM" 'Sets the threshold for signal tracking  
'in screen A to -50 dBm.

**Characteristics:** \*RST value: -120 dBm  
SCPI: device-specific

**Mode:** A-F

**CALCulate<1|2>:MARKer<1 to 4>:FUNCtion:STRack:TRACe** 1 to 3

This command defines the trace on which the largest signal is searched for in the selected measurement window. The function is independent of the selected marker, ie the numeric suffix <1 to 4> of MARKer is irrelevant. It is only available in the frequency domain (span > 0).

**Example:** "CALC2:MARK:FUNC:STR:TRAC 3" 'Defines trace 3 in screen B as the  
'trace for signal tracking.

**Characteristics:** \*RST value: 1  
SCPI: device-specific

**Mode:** A-F



**CALCulate<1|2>:MARKer<1 to 4>:FUNCtion:SUMMary[:STATe] ON | OFF**

This command switches on or off the previously selected time domain power measurements. Thus one or several measurements can be first selected and then switched on and off together with `CALC:MARK:FUNC:SUMM:STATe`.

The function is independent of the marker selection, ie the suffix of MARKer is irrelevant. It is only available in the time domain (span = 0).

**Example:** `"CALC:MARK:FUNC:SUMM:STAT ON"`

**Characteristics:** \*RST value: OFF  
SCPI: device-specific

**Mode:** A-T

**CALCulate<1|2>:MARKer<1 to 4>:FUNCtion:SUMMary:PPEak[:STATe] ON | OFF**

This command switches on or off the measurement of the positive peak value in the selected measurement window.

The function is independent of the marker selection, ie the numeric suffix <1 to 4> of MARKer is irrelevant. It is only available in the time domain (span = 0).

**Example:** `"CALC:MARK:FUNC:SUMM:PPE ON"` 'Switches on the function in screen A.

**Characteristics:** \*RST value: OFF  
SCPI: device-specific

**Mode:** A-T

**CALCulate<1|2>:MARKer<1 to 4>:FUNCtion:SUMMary:PPEak:RESult?**

This command is used to query the result of the measurement of the positive peak value in the selected measurement window. The measurement may have to be switched on previously.

The function is independent of the marker selection, ie the numeric suffix <1 to 4> of MARKer is irrelevant. It is only available in the time domain (span = 0).

A complete sweep with synchronization to sweep end must be performed between switching on the function and querying the measured value to obtain a valid query result. This is only possible in single sweep mode.

**Example:** `"INIT:CONT OFF"` 'Switches to single-sweep mode.  
`"CALC:MARK:FUNC:SUMM:PPE ON"` 'Switches on the function in screen A.  
`"INIT;*WAI"` 'Starts a sweep and waits for the end.  
`"CALC:MARK:FUNC:SUMM:PPE:RES?"` 'Outputs the result of screen A.

**Characteristics:** \*RST value: -  
SCPI: device-specific

**Mode:** A-T

This command is only a query and thus has no \*RST value assigned.

**CALCulate<1|2>:MARKer<1 to 4>:FUNCTION:SUMMARY:PPEak:AVERage:RESult?**

This command is used to query the result of the measurement of the averaged positive peak value in the selected measurement window. The query is only possible if averaging has been activated previously using CALCulate<1|2>:MARKer<1 to 4>:FUNCTION:SUMMARY:AVERage.

The function is independent of the marker selection, ie the numeric suffix <1 to 4> in MARKer is irrelevant. It is only available in the time domain (span = 0).

A complete sweep with synchronization to sweep end must be performed between switching on the function and querying the measured value to obtain a valid query result. This is only possible in single sweep mode.

**Example:**

"INIT:CONT OFF"	'Switches to single-sweep mode.
"CALC:MARK:FUNC:SUMM:PPE ON"	'Switches on the function in screen A.
"CALC:MARK:FUNC:SUMM:AVER ON"	'Switches on the calculation of average 'in screen A.
"INIT;*WAI"	'Starts a sweep and waits for the end.
"CALC:MARK:FUNC:SUMM:PPE:AVER:RES?"	'Outputs the result of screen A.

**Characteristics:** \*RST value: -  
SCPI: device-specific

**Mode:** A-T

This command is only a query and thus has no \*RST value assigned.

**CALCulate<1|2>:MARKer<1 to 4>:FUNCTION:SUMMARY:PPEak:PHOLd:RESult?**

This command is used to query the result of the measurement of the positive peak value with active peak hold function. The query is only possible if the peak hold function has been activated previously using CALCulate<1|2>:MARKer<1 to 4>:FUNCTION:SUMMARY:PHOLd.

The function is independent of the marker selection, ie the numeric suffix <1 to 4> of :MARKer is irrelevant. It is only available in the time domain (span = 0).

A complete sweep with synchronization to sweep end must be performed between switching on the function and querying the measured value to obtain a valid query result. This is only possible in single sweep mode.

**Example:**

"INIT:CONT OFF"	'Switches to single-sweep mode.
"CALC:MARK:FUNC:SUMM:PPE ON"	'Switches on the function in screen A.
"CALC:MARK:FUNC:SUMM:PHOL ON"	'Switches on the measurement of the 'peak value in screen A.
"INIT;*WAI"	'Starts a sweep and waits for the end.
"CALC:MARK:FUNC:SUMM:PPE:PHOL:RES?"	'Outputs the result of screen A.

**Characteristics:** \*RST value: -  
SCPI: device-specific

**Mode:** A-T

This command is only a query and thus has no \*RST value assigned.

**CALCulate<1|2>:MARKer<1 to 4>:FUNCtion:SUMMary:RMS[:STATe] ON | OFF**

This command switches on or off the measurement of the effective (RMS) power in the selected measurement window. If necessary the function is switched on previously.

The function is independent of the marker selection, ie the numeric suffix <1 to 4> of :MARKer is irrelevant. It is only available in the time domain (span = 0).

**Example:** "CALC2:MARK:FUNC:SUM:RMS ON" 'Switches on the function in screen B.

**Characteristics:** \*RST value: OFF  
SCPI: device-specific

**Mode:** A-T

**CALCulate<1|2>:MARKer<1 to 4>:FUNCtion:SUMMary:RMS:RESult?**

This command queries the result of the measurement of the RMS power value in the selected measurement window.

The function is independent of the marker selection, ie the numeric suffix <1 to 4> of :MARKer is irrelevant. It is only available in the time domain (span = 0).

A complete sweep with synchronization to sweep end must be performed between switching on the function and querying the measured value to obtain a valid query result. This is only possible in single sweep mode.

**Example:** "INIT:CONT OFF" 'Switches to single-sweep mode.  
"CALC:MARK:FUNC:SUMM:RMS ON" 'Switches on the function in screen A.  
"INIT;\*WAI" 'Starts a sweep and waits for the end.  
"CALC:MARK:FUNC:SUMM:RMS:RES?" 'Outputs the result of screen A.

**Characteristics:** \*RST- value: -  
SCPI: device-specific

**Mode:** A-T

This command is only a query and thus has no \*RST value assigned.

**CALCulate<1|2>:MARKer<1 to 4>:FUNCtion:SUMMary:RMS:AVERAge:RESult?**

This command queries the result of the measurement of the averaged RMS value in the selected measurement window. The query is only possible if averaging has been activated previously using CALCulate<1|2>:MARKer<1 to 4>:FUNCtion:SUMMary:AVERAge.

The function is independent of the marker selection, ie the numeric suffix <1 to 4> of :MARKer is irrelevant. It is only available in the time domain (span = 0).

A complete sweep with synchronization to sweep end must be performed between switching on the function and querying the measured value to obtain a valid query result. This is only possible in single sweep mode.

**Example:** "INIT:CONT OFF" 'Switches to single-sweep mode.  
"CALC:MARK:FUNC:SUMM:RMS ON" 'Switches on the function in screen A.  
"CALC:MARK:FUNC:SUMM:AVER ON" 'Switches on the average value  
'calculation in screen A.  
"INIT;\*WAI" 'Starts a sweep and waits for the end.  
"CALC:MARK:FUNC:SUMM:RMS:AVER:RES?" 'Outputs the result of screen A.

**Characteristics:** \*RST- value: -  
SCPI: device-specific

**Mode:** A-T

This command is only a query and thus has no \*RST value assigned.

**CALCulate<1|2>:MARKer<1 to 4>:FUNction:SUMMary:RMS:PHOLd:RESult?**

This command queries the result of the measurement of the RMS value with active peak hold in the selected measurement window. The query is only possible only if the peak hold function has been activated previously using CALCulate<1|2>:MARKer<1 to 4>: FUNction:SUMMary:PHOLd.

The function is independent of the marker selection, ie the numeric suffix <1 to 4> of :MARKer is irrelevant. It is only available in the time domain (span = 0).

A complete sweep with synchronization to sweep end must be performed between switching on the function and querying the measured value to obtain a valid query result. This is only possible in single sweep mode.

**Example:**

"INIT:CONT OFF"	'Switches to single-sweep mode.
"CALC:MARK:FUNC:SUMM:RMS ON"	'Switches on the function in screen A.
"CALC:MARK:FUNC:SUMM:PHOL ON"	'Switches on the peak value measurement in screen A.
"INIT;*WAI"	'Starts a sweep and waits for the end.
"CALC:MARK:FUNC:SUMM:RMS:PHOL:RES?"	'Outputs the result of screen A.

**Characteristics:** \*RST- value: -  
SCPI: device-specific

**Mode:** A-T

This command is only a query and thus has no \*RST value assigned.

**CALCulate<1|2>:MARKer<1 to 4>:FUNction:SUMMary:MEAN[:STATe] ON | OFF**

This command switches on or off the measurement of the mean value in the selected measurement window.

The function is independent of the marker selection, ie the numeric suffix <1 to 4> of :MARKer is irrelevant. It is only available in the time domain (span = 0)..

**Note:** *The measurement is performed on the trace on which marker 1 is positioned. In order to evaluate another trace, marker 1 must be positioned on another trace with CALC:MARK:TRAC 1|2|3.*

**Example:** "CALC:MARK:FUNC:SUMM:MEAN ON" 'Switches on the function in screen A.

**Characteristics:** \*RST value: OFF  
SCPI: device-specific

**Mode:** A-T



**CALCulate<1|2>:MARKer<1 to 4>:FUNCTION:SUMMARY:MEAN:RESult?**

This command queries the result of the measurement of the mean value in the selected measurement window. The function is independent of the marker selection, ie the numeric suffix <1 to 4> of :MARKer is irrelevant. It is only available in the time domain (span = 0).

A complete sweep with synchronization to sweep end must be performed between switching on the function and querying the measured value to obtain a valid query result. This is only possible in single sweep mode.

**Example:**

"INIT:CONT OFF"	'Switches to single-sweep mode.
"CALC:MARK:FUNC:SUMM:MEAN ON"	'Switches on the function in screen A.
"INIT;*WAI"	'Starts a sweep and waits for the end.
"CALC:MARK:FUNC:SUMM:MEAN:RES?"	'Outputs the result of screen A.

**Characteristics:** \*RST- value: -  
SCPI: device-specific

**Mode:** A-T

This command is only a query and thus has no \*RST value assigned.

**CALCulate<1|2>:MARKer<1 to 4>:FUNCTION:SUMMARY:MEAN:AVERAGE:RESult?**

This command queries the result of the measurement of the averaged mean value in the selected measurement window. The query is only possible if averaging has been activated previously using CALCulate<1|2>:MARKer<1 to 4>:FUNCTION:SUMMARY:AVERAGE.

The function is independent of the marker selection, ie the numeric suffix <1 to 4> of :MARKer is irrelevant. It is only available in the time domain (span = 0).

A complete sweep with synchronization to sweep end must be performed between switching on the function and querying the measured value to obtain a valid query result. This is only possible in single sweep mode.

**Example:**

"INIT:CONT OFF"	'Switches to single-sweep mode.
"CALC:MARK:FUNC:SUMM:MEAN ON"	'Switches on the function in screen A.
"CALC:MARK:FUNC:SUMM:AVER ON"	'Switches on the average value calculation in screen A.
"INIT;*WAI"	'Starts a sweep and waits for the end.
"CALC:MARK:FUNC:SUMM:MEAN:AVER:RES?"	'Outputs the result of screen A.

**Characteristics:** \*RST- value: -  
SCPI: device-specific

**Mode:** A-T

This command is only a query and thus has no \*RST value assigned.

**CALCulate<1|2>:MARKer<1 to 4>:FUNCTION:SUMMARY:MEAN:PHOLD:RESult?**

This command queries the result of the measurement of the mean value with active peak hold in the selected measurement window. The query is only possible if the peak hold function has been switched on previously using CALCulate<1|2>:MARKer<1 to 4>:FUNCTION:SUMMARY:PHOLD.

The query is possible only if the peak hold function is active. The function is independent of the marker selection, ie the numeric suffix <1 to 4> of :MARKer is irrelevant. It is only available in the time domain (span = 0).

A complete sweep with synchronization to sweep end must be performed between switching on the function and querying the measured value to obtain a valid query result. This is only possible in single sweep mode.

**Example:**

"INIT:CONT OFF"	'Switches to single-sweep mode
"CALC:MARK:FUNC:SUMM:MEAN ON"	'Switches on the function in screen A
"CALC:MARK:FUNC:SUMM:PHOL ON"	'Switches on the peak value measurement in screen A
"INIT;*WAI"	'Starts a sweep and waits for the end
"CALC:MARK:FUNC:SUMM:MEAN:PHOL:RES?"	'Outputs the result of screen A.

**Characteristics:** \*RST- value: -  
SCPI: device-specific

**Mode:** A-T

This command is only a query and thus has no \*RST value assigned.

**CALCulate<1|2>:MARKer<1 to 4>:FUNCTION:SUMMARY:SDEVIation[:STATE] ON | OFF**

This command switches on or off the measurement of the standard deviation in the selected measurement window. The function is independent of the marker selection, ie the numeric suffix <1 to 4> of :MARKer is irrelevant. It is only available in the time domain (span = 0)..

On switching on the measurement, the mean power measurement is switched on as well.

**Example:**

"CALC2:MARK:FUNC:SUMM:SDEV ON"	'Switches on the measurement of the standard deviation in screen B.
--------------------------------	---

**Characteristics:** \*RST value: OFF  
SCPI: device-specific

**Mode:** A

**CALCulate<1|2>:MARKer<1 to 4>:FUNCtion:SUMMary:SDEViation:RESult?**

This command queries the results of the standard deviation measurement. The function is independent of the marker selection, ie the numeric suffix <1 to 4> of :MARKer is irrelevant. It is only available in the time domain (span = 0).

A complete sweep with synchronization to sweep end must be performed between switching on the function and querying the measured value to obtain a valid query result. This is only possible in single sweep mode.

**Example:**

"INIT:CONT OFF"	'Switches to single-sweep mode.
"CALC:MARK:FUNC:SUMM:SDEV ON"	'Switches on the function in screen A.
"INIT;*WAI"	'Starts a sweep and waits for the end.
"CALC:MARK:FUNC:SUMM:SDEV:RES?"	'Outputs the result of screen A.

**Characteristics:** \*RST value: -  
SCPI: device-specific

**Mode:** A-T

This command is only a query and thus has no \*RST value assigned.

**CALCulate<1|2>:MARKer<1 to 4>:FUNCtion:SUMMary:SDEViation:AVERAge:RESult?**

This command queries the result of the averaged standard deviation determined in several sweeps in the selected measurement window. The query is possible only if averaging is active. The function is independent of the marker selection, ie the numeric suffix <1 to 4> of :MARKer is irrelevant. It is only available in the time domain (span = 0).

A complete sweep with synchronization to sweep end must be performed between switching on the function and querying the measured value to obtain a valid query result. This is only possible in single sweep mode.

**Example:**

"INIT:CONT OFF"	'Switches to single-sweep mode.
"CALC:MARK:FUNC:SUMM:SDEV ON"	'Switches on the function in screen A.
"CALC:MARK:FUNC:SUMM:AVER ON"	'Switches on the calculation of average 'in screen A.
"INIT;*WAI"	'Starts a sweep and waits for the end.
"CALC:MARK:FUNC:SUMM:MEAN:SDEV:RES?"	'Outputs the result of screen A.

**Characteristics:** \*RST value: -  
SCPI: device-specific

**Mode:** A-T

This command is only a query and thus has no \*RST value assigned.

**CALCulate<1|2>:MARKer<1 to 4>:FUNCtion:SUMMary:SDEViation:PHOLd:RESult?**

This command queries the maximum standard deviation value determined in several sweeps in the selected measurement window. The query is possible only if the peak hold function is active.

The function is independent of the marker selection, ie the numeric suffix <1 to 4> of :MARKer is irrelevant. It is only available in the time domain (span = 0).

A complete sweep with synchronization to sweep end must be performed between switching on the function and querying the measured value to obtain a valid query result. This is only possible in single sweep mode.

**Example:**

"INIT:CONT OFF"	'Switches to single-sweep mode.
"CALC:MARK:FUNC:SUMM:SDEV ON"	'Switches on the function in screen A.
"CALC:MARK:FUNC:SUMM:PHOL ON"	'Switches on the peak value measurement in screen A.
"INIT;*WAI"	'Starts a sweep and waits for the end.
"CALC:MARK:FUNC:SUMM:SDEV:PHOL:RES?"	'Outputs the result of screen A.

**Characteristics:** \*RST value: -  
SCPI: device-specific

**Mode:** A-T

This command is only a query and thus has no \*RST value assigned.

**CALCulate<1|2>:MARKer<1 to 4>:FUNCtion:SUMMary:PHOLd ON | OFF**

This command switches on or off the peak-hold function for the active time domain power measurement in the indicated measurement window. The function is independent of the marker selection, ie the numeric suffix <1 to 4> of :MARKer is irrelevant. It is only available in the time domain (span = 0).

The peak-hold function is reset by switching it off and on again.

**Example:** "CALC:MARK:FUNC:SUMM:PHOL ON" 'Switches on the function in screen A.

**Characteristics:** \*RST value: OFF  
SCPI: device-specific

**Mode:** A-T

The peak-hold function is reset by switching off and on, again.

**CALCulate<1|2>:MARKer<1 to 4>:FUNction:SUMMary:AVERage** ON | OFF

This command switches on or off averaging for the active time domain power measurement in the indicated window. The function is independent of the marker selection, ie the numeric suffix <1 to 4> of :MARKer is irrelevant. It is only available in the time domain (span = 0).

Averaging is reset by switching it off and on again.

The number of results required for the calculation of average is defined with [SENSe<1 | 2>:]AVERage:COUNT.

It should be noted that synchronization to the end of averaging is only possible in single sweep mode.

**Example:**

"INIT:CONT OFF"	'Switches to single-sweep mode.
"CALC2:MARK:FUNC:SUMM:AVER ON"	'Switches on the calculation of average in screen B.
"AVER:COUN 200"	'Sets the measurement counter to 200.
"INIT;*WAI"	'Starts a sweep and waits for the end.

**Characteristics:** \*RST value: OFF  
SCPI: device-specific

**Mode:** A-T

**CALCulate<1|2>:MARKer<1 to 4>:FUNction:SUMMary:MODE** ABSolute | RELative

This command selects absolute or relative time domain power measurement in the indicated measurement window. The function is independent of the marker selection, ie the numeric suffix <1 to 4> of :MARKer is irrelevant. It is only available in the time domain (span = 0).

The reference power for relative measurement is defined with CALCulate:MARKer:FUNction:SUMMary:REFERENCE:AUTO ONCE. If the reference power is not defined, the value 0 dBm is used.

**Example:**

"CALC:MARK:FUNC:SUMM:MODE REL"	' Switches the time domain power measurement to relative.
--------------------------------	---

**Characteristics:** \*RST value: ABSolute  
SCPI: device-specific

**Mode:** A-T

**CALCulate<1|2>:MARKer<1 to 4>:FUNCTION:SUMMARY:REFERENCE:AUTO ONCE**

With this command the currently measured average value (. . :SUMMARY:MEAN) and RMS value (. . :SUMMARY:RMS) are declared as reference values for relative measurements in the indicated measurement window. The function is independent of the marker selection, ie the numeric suffix <1 to 4> of :MARKer is irrelevant. It is only available in the time domain (span = 0).

If the measurement of RMS value and average is not activated, the reference value 0 dBm is used.

If the function . . . :SUMMARY:AVERAGE or . . . :SUMMARY:PHOLD is switched on, the current value is the accumulated measurement value at the time considered.

**Example:** "CALC:MARK:FUNC:SUMM:REF:AUTO ONCE"  
' Takes the currently measured power in  
'screen A as reference value for the relative  
'time domain power measurement.

**Characteristics:** \*RST value: -  
SCPI: device-specific

**Mode:** A-T

This command is an event and therefore has no \*RST value assigned and has no query.

**CALCulate<1|2>:MARKer<1 to 4>:FUNCTION:SUMMARY:AOFF**

This command switches off all time domain measurements in the selected measurement window. The function is independent of the marker selection, ie the numeric suffix <1 to 4> of :MARKer is irrelevant. It is only available in the time domain (span = 0).

**Example:** "CALC2:MARK:FUNC:SUMM:AOFF"  
'Switches off the time domain power  
'measurement functions in screen B.

**Characteristics:** \*RST value: -  
SCPI: device-specific

**Mode:** A-T

This command is an event and therefore has no \*RST value assigned and has no query.

**CALCulate<1|2>:MARKer<1 to 4>:FUNCtion:MSUMmary?**

<time offset of first pulse>, <measurement time>, <period>, < # of pulses to measure>

The commands of this subsystem are used to determine the power of a sequence of signal pulses having the same interval, as are typical for the slots of a GSM signal, for example. The number of pulses to be measured as well as the measurement time and the period can be set. To define the position of the first pulse in the trace, a suitable offset can be entered.

The evaluation is performed on the measurement data of a previously recorded trace. The data recorded during the set measurement time is combined to a measured value for each pulse according to the detector specified and the indicated number of results is output as a list.

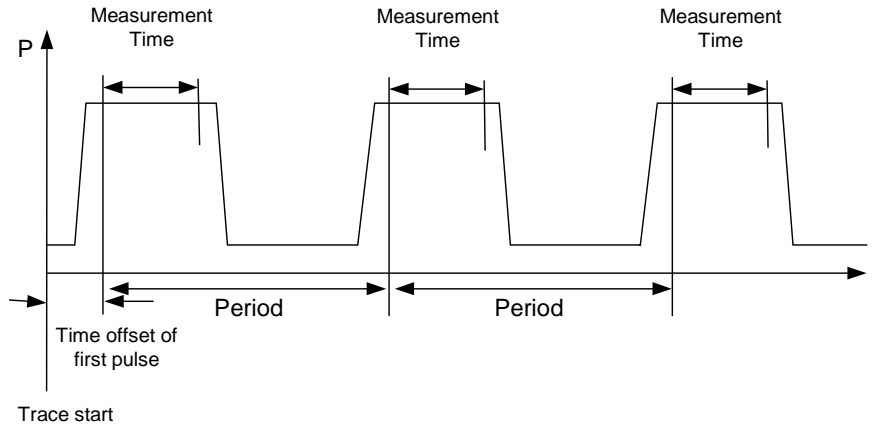

TRACE 1 of the selected screen is always used by the function. The suffix of MARKer will be ignored.

<b>Example:</b>	<pre>"DISP:WIND:TRAC:Y:RLEV -10dBm" "INP:ATT 30 dB" "FREQ:CENT 935.2MHz;SPAN 0Hz" "BAND:RES 1MHz;VID 3MHz" "DET RMS" "TRIG:SOUR VID;LEV:VID 50 PCT" "SWE:TIME 50ms" "INIT;*WAI" "CALC:MARK:FUNC:MSUM? 50US,450US,576.9US,8"</pre>	<pre>'Sets the reference level to 10 dB 'Sets the input attenuation to 30 dB 'Sets the receive frequency to 935.2 MHz and the span to 0 Hz 'Sets the resolution bandwidth to 1 MHz and the video bandwidth to 3 MHz 'Sets the RMS detector 'Selects the trigger source VIDEo and sets the level of the video trigger source to 50 PCT 'Sets the sweep time to 50 ms 'Starts the measurement with synchronization 'Queries 8 bursts with an offset of 50 μs, a test time of 450 μs and a period of 576.9 μs</pre>
-----------------	---	--

**Characteristics:**

\*RST value:-  
SCPI:device-specific

**Mode:**

A-Z

## CALCulate:MATH Subsystem

The CALCulate:MATH subsystem allows to process data from the SENSE-subsystem in numeric expressions. The measurement windows are selected by CALCulate1 (screen A) or CALCulate2 (screen B).

COMMAND	PARAMETERS	UNIT	COMMENT
CALCulate<1 2> :MATH [:EXPRession] [:DEFine] :POSition :STATe :MODE	<expr> <numeric_value> <Boolean> LINear   LOGarithmic	-- PCT -- --	

### CALCulate<1|2>:MATH[:EXPRession][:DEFine] <expr>

This command defines the mathematical expression for relating traces to trace1.

The zero point of the result display can be defined with CALC : MATH : POS. Command CALCulate : MATH : STATe switches the mathematical relation of traces on or off .

**Parameter:** <expr> ::= 'OP1 - OP2'  
OP1 ::= TRACE1  
OP2 ::= TRACE2 | TRACE3

**Example:** "CALC1 : MATH ( TRACE1 - TRACE2 )" 'Selects the subtraction of trace 1  
'from trace 2 in screen A.  
"CALC2 : MATH ( TRACE1 - TRACE3 )" 'Selects the subtraction of trace 1  
'from trace 3 in screen B.

**Characteristics:** \*RST value: -  
SCPI: conforming

**Mode:** A

### CALCulate<1|2>:MATH:POSition -100PCT to 200PCT

This command defines the position of the result of the trace mathematics in the selected measurement window. The indication is in % of the screen height, with 100% corresponding to the upper diagram border.

**Example:** "CALC : MATH : POS 50PCT" 'Sets the position in screen A to the  
'horizontal diagram center.

**Characteristics:** \*RST value: 50 %  
SCPI: device-specific

**Mode:** A



**CALCulate<1|2>:MATH:STATe** ON | OFF

This command switches the mathematical relation of traces on or off.

**Example:** "CALC:MATH:STAT ON" 'Switches on the trace mathematics in 'screen A.

**Characteristics:** \*RST value: OFF  
SCPI: conforming

**Mode:** A

**CALCulate<1|2>:MATH:MODE** LINear | LOGarithmic

This command selects linear or logarithmic (= video) calculation of the mathematical functions related to the traces. The calculation of the average is one of the affected functions. The setting is valid for all measurement windows, ie the numeric suffix <1 | 2> of CALCulate is irrelevant.

**Example:** "CALC:MATH:MODE LIN" 'Switches on the linear calculation.

**Characteristics:** \*RST value: LOG  
SCPI: device-specific

**Mode:** A

## CALCulate:PEAKsearch - Subsystem

The CALCulate:PEAKsearch subsystem allows data to be processed for final measurement.

Command	PARAMETER	Unit	Comment
CALCulate<1 2> :PEAKsearch [:IMMediate] :MARGin :SUBRanges :METHod :PSEarch [:IMMediate] :MARGin :SUBRanges :METHod	<numeric_value> <numeric_value> SUBRange   PEAK <numeric_value> <numeric_value> SUBRange   PEAK	dB -- dB --	

### CALCulate<1|2>:PEAKsearch|PSEarch[:IMMediate]

This command activates the generation of final measurement data.

The numeric suffix in CALCULATE<1 | 2> is not significant.

**Example:** "CALC:PEAK"  
**Features:** \*RST value: -  
 SCPI: device specific  
**Mode:** R

### CALCulate<1|2>:PEAKsearch|PSEarch:MARGin MINimum .. MAXimum

This command defines the margin of the final measurement..

The numeric suffix in CALCULATE<1 | 2> is not significant.

**Example:** "CALC:PEAK:MARG 5 dB"  
**Features:** \*RST value: 6 dB  
 SCPI: device specific  
**Mode:** R

### CALCulate<1|2>:PEAKsearch|PSEarch:SUBRanges 1 to 500

This command defines the number of subranges for the final measurement

The numeric suffix in CALCULATE<1 | 2> is not significant.

**Example:** "CALC:PEAK:SUBR 10"  
**Features:** \*RST value: 25  
 SCPI: device specific  
**Mode:** R

### CALCulate<1|2>:PEAKsearch|PSEarch:METHod SUBRange | PEAK

This command defines the method that is used to determine the maxima of a scan.

The numeric suffix in CALCULATE<1 | 2> is not significant.

**Example:** "CALC:PEAK:METH SUBR"  
**Features:** \*RST value: PEAK  
 SCPI: device specific  
**Mode:** R

## CALCulate:STATistics Subsystem

The CALCulate:STATistics subsystem controls the statistical measurement functions in the instrument. The measurement window cannot be selected with these functions. The numeric suffix in CALCulate is therefore ignored.

COMMAND	PARAMETERS	UNIT	COMMENT
CALCulate			
:STATistics			
:APD			
[:STATe]	<Boolean>	--	
:CCDF			
[:STATe]	<Boolean>	--	
:NSAMples	<numeric_value>		
:SCALe			
:AUTO	ONCE		
:X			
:RLEVel	<numeric_value>	DBM	
:RANGe	<numeric_value>	DB	
:Y			
:UPPer	<numeric_value>		
:LOWer	<numeric_value>		
:PRESet			
:RESult<1 to 3>?	MEAN   PEAK   CFACtor   ALL		query only

### CALCulate:STATistics:APD[:STATe] ON | OFF

This command switches on or off the measurement of amplitude distribution (APD). On activating this function, the CCDF measurement is switched off.

**Example:** "CALC:STAT:APD ON" 'Switches on the APD measurement.

**Characteristics:** \*RST value: OFF  
SCPI: device-specific

**Mode:** A

### CALCulate:STATistics:CCDF[:STATe] ON | OFF

This command switches on or off the measurement of the complementary cumulative distribution function (CCDF). On activating this function, the APD measurement is switched off.

**Example:** "CALC:STAT:CCDF ON" 'Switches on the CCDF measurement.

**Characteristics:** \*RST value: OFF  
SCPI: device-specific

**Mode:** A

**CALCulate:STATistics:NSAMples** 100 to 1E9

This command sets the number of measurement points to be acquired for the statistical measurement functions.

**Example:** "CALC:STAT:NSAM 500" 'Sets the number of measurement points to be acquired to 500.

**Characteristics:** \*RST value: 100000  
SCPI: device-specific

**Mode:** A

**CALCulate:STATistics:SCALE:AUTO ONCE**

This command optimizes the level setting of the instrument depending on the measured peak power, in order to obtain maximum instrument sensitivity.

To obtain maximum resolution, the level range is set as a function of the measured spacing between peak power and the minimum power for the APD measurement and of the spacing between peak power and mean power for the CCDF measurement. In addition, the probability scale for the number of test points is adapted.

**Note:**

*Subsequent commands have to be synchronized with \*WAI, \*OPC or \*OPC? to the end of the autorange process which would otherwise be aborted.*

**Example:** "CALC:STAT:SCALE:AUTO ONCE;\*WAI" 'Adapts the level setting for statistical measurements.

**Characteristics:** \*RST value: --  
SCPI: device-specific

**Mode:** A

This command is an event and therefore has no \*RST value assigned and has no query.

**CALCulate:STATistics:SCALE:X:RLEVel** -130dBm to 30dBm

This command defines the reference level for the X-axis of the measurement diagram. The setting is identical to the reference level setting using the command DISPLAY:WINDOW:TRACE:Y:RLEVel.

With the reference level offset <> 0 the indicated value range of the reference level is modified by the offset.

The unit depends on the setting performed with CALC:UNIT.

**Example:** "CALC:STAT:SCALE:X:RLEV -60dBm"

**Characteristics:** \*RST value: -20dBm  
SCPI: device-specific

**Mode:** A

**CALCulate:STATistics:SCALE:X:RANGe** 10dB to 200dB

This command defines the level range for the X-axis of the measurement diagram. The setting is identical to the level range setting defined with the command `DISPlay:WINDow:TRACe:Y:SCALE`.

**Example:** "CALC:STAT:SCAL:X:RANG 20dB"

**Characteristics:** \*RST value: 100dB  
SCPI: device-specific

**Mode:** A

**CALCulate:STATistics:SCALE:Y:UPPer** 1E-8 to 1.0

This command defines the upper limit for the Y-axis of the diagram in statistical measurements. Since probabilities are specified on the Y-axis, the entered numerical values are dimensionless.

**Example:** "CALC:STAT:Y:UPP 0.01"

**Characteristics:** \*RST value: 1.0  
SCPI: device-specific

**Mode:** A

**CALCulate:STATistics:SCALE:Y:LOWer** 1E-9 to 0.1

This command defines the lower limit for the Y-axis of the diagram in statistical measurements. Since probabilities are specified on the Y-axis, the entered numerical values are dimensionless.

**Example:** "CALC:STAT:SCAL:Y:LOW 0.001"

**Characteristics:** \*RST value: 1E-6  
SCPI: device-specific

**Mode:** A

**CALCulate:STATistics:PRESet**

This command resets the scaling of the X- and Y-axes in a statistical measurement. The following values are set:

X-axis ref level: -20 dBm  
X-axis range APD: 100 dB  
X-axis range CCDF: 20 dB

Y-axis upper limit: 1.0  
Y-axis lower limit: 1E-6

**Example:** "CALC:STAT:PRES" ' Resets the scaling for statistical functions

**Characteristics:** \*RST value: --  
SCPI: device-specific

**Mode:** A

This command is an event and therefore has no \*RST value assigned and has no query.

**CALCulate:STATistics:RESult<1 to 3>? MEAN | PEAK | CFACtor | ALL**

This command reads out the results of statistical measurements of a recorded trace. The trace is selected with the numeric suffix <1 to 3> attached to RESult.

**Parameter:** The required result is selected via the following parameters:

MEAN Average (=RMS) power in dBm measured during the measurement time.

PEAK Peak power in dBm measured during the measurement time.

CFACtor Determined CREST factor (= ratio of peak power to average power) in dB.

ALL Results of all three measurements mentioned before, separated by commas:  
<mean power>,<peak power>,<crest factor>

**Example:** "CALC:STAT:RES2? ALL" 'Reads out the three measurement results of trace 2. Example of answer string:  
'5.56,19.25,13.69  
'ie mean power: 5.56 dBm, peak power 19.25 dBm, CREST factor 13.69 dB

**Characteristics:** \*RST value: --  
SCPI: device-specific

**Mode:** A

## CALCulate:THReshold Subsystem

The CALCulate:THReshold subsystem controls the threshold value for the maximum/minimum search of markers. The measurement windows are selected by CALCulate 1 (screen A) or 2 (screen B).

COMMAND	PARAMETERS	UNIT	COMMENT
CALCulate<1 2> :DLINe	<numeric_value>	DBM   DB	
:STATe	<Boolean>	DBM   DB	
:THReshold	<numeric_value>		
:STATe	<Boolean>	Hz	
:FLINe<1 2>	<numeric_value>		
:STATe	<Boolean>	S	
:TLINe<1 2>	<numeric_value>		
:STATe	<Boolean>		

### CALCulate<1|2>:DLINe<1|2> <numeric\_value>

This command defines the position of the display line.

**Example:** "CALC:DLIN -20dBm" 'Setss display line 1 in screen A at -20dBm

**Features:** \*RST value: - (STATe to OFF)  
SCPI: device-specific

**Modes:** R, A

The display lines mark the given level in the display.

### CALCulate<1|2>:DLINe<1|2>:STATe ON | OFF

This command switches the display line on or off.

**Example:** "CALC2:DLIN2:STAT OFF" 'Switches off display line 2 in screen B.

**Features:** \*RST value: OFF  
SCPI: device-specific

**Modes:** R, A

### CALCulate<1|2>:THReshold MINimum to MAXimum (depending on current unit)

This command defines the threshold value for the maximum/minimum search of markers with marker search functions MAX PEAK, NEXT PEAK, etc. in the selected measurement window. The associated display line is automatically switched on.

**Example:** "CALC:THR -82DBM" 'Sets the threshold value for screen A to -82 dBm.

**Characteristics:** \*RST value: - (STATe to OFF)  
SCPI: device-specific

**Mode:** R, A

**CALCulate<1|2>:THReshold:STATe** ON | OFF

This command switches on or off the threshold line in the selected measurement window. The unit depends on the setting performed with `CALC:UNIT`.

**Example:** "CALC2:THR:STAT ON" 'Switches on the threshold line in screen B.

**Characteristics:** \*RST value: OFF  
SCPI: device-specific

**Mode:** R, A

**CALCulate<1|2>:FLINe<1|2>** 0 GHz to  $f_{max}$ 

This command defines the position of the frequency lines

**Example:** "CALC:FLIN2 120MHz" 'Sets frequency line 2 in screen A to 120 MHz

**Features:** \*RST value: - (STATe to OFF)  
SCPI: device-specific

**Modes:** R, A-F

The frequency lines mark the given frequencies in the display. Frequency lines are only valid for a `SPAN > 0`.

**CALCulate<1|2>:FLINe<1|2>:STATe** ON | OFF

This command switches the frequency line on or off.

**Example:** "CALC:FLIN2:STAT ON" 'Switches on frequency line 2 in screen A.

**Features:** \*RST value: OFF  
SCPI: device-specific

**Modes:** R, A-F

**CALCulate<1|2>:TLINe<1|2>** 0 to 1000s

This command defines the position of the time lines.

**Example:** "CALC:TLIN 10ms" 'Sets time line 1 in screen A to 10 ms

**Features:** \*RST value: - (STATe to OFF)  
SCPI: device-specific

**Modes:** A-T

The time lines mark the given times in the display. Time lines are only valid for a `SPAN = 0`.

**CALCulate<1|2>:TLINe<1|2>:STATe** ON | OFF

This command switches the time line on or off.

**Example:** "CALC:TLIN2:STAT ON" 'Switches on time line 2 in screen A.

**Features:** \*RST value: OFF  
SCPI: device-specific

**Modes:** A-T



## CALCulate:UNIT Subsystem

The CALCulate:Unit subsystem defines the units for the level axis (Y-axis).

COMMAND	PARAMETERS	UNIT	COMMENT
CALCulate<1 2> :UNIT :POWer	DBM   V   A   W DBPW   WATT   DBUV   DBMV   VOLT   DBPT   DBUA   AMPere		

**CALCulate<1|2>:UNIT:POWer** DBM | V | A | W | DBPW | WATT | DBUV | DBMV | VOLT | DBUA | AMPere | DBPT

This command selects the unit for the level axis in the selected measurement window.

**Example:** "CALC:UNIT:POW DBM" 'Sets the unit of the level axis of screen A to dBm.

**Characteristics:** \*RST value: dBm  
SCPI: device-specific

**Mode:** R, A

In receiver mode, the units DBM, DBUV, DBUA, DBPW, DBT, DBUV\_MHZ, DBMV\_MHZ and DBUA\_MHZ are available. Additional units can be selected using the transducer factors (command CORREction:TSET:UNIT). The transducer units can be queried with command CALCulate<1|2>:UNIT:POWer?, but they can be selected only with command CORREction:TSET:UNIT.

## CALibration Subsystem

The commands of the CALibration subsystem determine the data for system error correction in the instrument.

COMMAND	PARAMETERS	UNIT	COMMENT
CALibration			
[:ALL]?	--	--	query only
:ABORt	--	--	no query
:RESult?	--	--	query only
:STATe	<Boolean>	--	

### CALibration[:ALL]?

This command initiates the acquisition of system error correction data. A "0" is returned if the acquisition was successful.

**Note:** *During the acquisition of correction data the instrument does not accept any remote control commands, except*  
*\*RST*  
*CALibration:ABORt*

In order to recognize when the acquisition of correction data is completed, the MAV bit in the status byte can be used. If the associated bit is set in the Service Request Enable Register, the instrument generates a service request after the acquisition of correction data has been completed.

**Example:**

```
*CLS "          ' Resets the status management.
*SRE 16 "      ' Enables MAV bit in the Service Request Enable Register.
*CAL? "        ' Starts the correction data recording and then a service
               ' request is generated.
```

**Characteristics:** \*RST value: -  
 SCPI: conforming

**Mode:** all

### CALibration:ABORt

This command aborts the acquisition of correction data and restores the last complete correction data set.

**Example:** "CAL:ABOR"

**Characteristics:** \*RST value: -  
 SCPI: device-specific

**Mode:** all

This command is an event and therefore has no \*RST value assigned and has no query.

**CALibration:RESult?**

This command outputs the results of the correction data acquisition. The lines of the result table (see section "Recording the correction data of ESPI – CAL key") are output as string data separated by commas:

```
"Total Calibration Status: PASSED", "Date (dd/mm/yyyy): 12/07/2001",  
"Time: 16:24:54", "Runtime:00.06"
```

**Example:** "CAL:RES?"

**Characteristics:** \*RST value: --  
SCPI: device-specific

**Mode:** all

**CALibration:STATe ON | OFF**

This command determines whether the current calibration data are taken into account by the instrument (ON) or not (OFF).

**Example:** "CAL:STAT OFF" 'Sets up the instrument to ignore the calibration data.

**Characteristics:** \*RST value: -  
SCPI: conforming

**Mode:** all

## DIAGnostic Subsystem

The DIAGnostic subsystem contains the commands which support instrument diagnostics for maintenance, service and repair. In accordance with the SCPI standard, all of these commands are device-specific.

The measurement windows are selected by DIAGnostic1 (screen A) or DIAGnostic2 (screen B) .

COMMAND	PARAMETERS	UNIT	COMMENT
DIAGnostic<1 2> :SERVice :INPut [:SElect] :PULSed [:STATe] :PRATe :SFUNction :NSOurce :CSOurce [:POWer] :STESt :RESult?	CALibration   RF  <string> <Boolean>  <numeric_value>	--       DBM	no query       query only

### DIAGnostic<1|2>:SERVice:INPut[:SElect] CALibration | RF

This command toggles between the RF input on the front panel and the internal 128-MHz reference signal in the selected measurement window. The level of the 128-MHz signals can be selected by command `DIAG:SERV:CSOURCE`.

**Example:** "DIAG:SERV:INP CAL"

**Characteristics:** \*RST value: RF  
SCPI: device-specific

**Mode:** all

### DIAGnostic<1|2>:SERVice:INPut:PULSed[:STATe] ON | OFF

This command toggles the calibration signal in the selected measurement window between pulsed and non-pulsed. The selection takes effect only if the RF input has been set to the internal reference signal using `DIAG:SERV:INP CAL`.

**Example:** "DIAG:SERV:INP CAL;  
DIAG:SERV:INP:PULS ON"

**Characteristics:** \*RST value: OFF  
SCPI: device-specific

**Mode:** all

### DIAGnostic<1|2>:SERVice:INPut:PULSed:PRATe <numeric\_value>

This command selects the pulse rate for the pulsed calibration signal in the selected measurement window. Available pulse frequencies are 10 kHz, 100 kHz, 200 kHz, 500 kHz, 1 MHz, 2 MHz, 4 MHz and 8 MHz.

**Example:** "DIAG:SERV:INP:PULS:PRAT 2 MHz"

**Characteristics:** \*RST value: -  
SCPI: device-specific

**Mode:** all

**DIAGnostic<1|2>:SERvice:SFUNction** <string>...

This command activates a service function which can be selected by indicating the five parameters: function group number, board number, function number, parameter 1 and parameter 2 (see service manual). The contents of the parameter string is identical to the code to be entered in the data entry field of manual operation.

The entry of a service function is accepted only if the system password Level 1 or Level 2 has been entered previously (command: SYSTem:SECurity).

The numeric suffix <1|2> is ignored with this command.

**Note:** *The service functions of the instrument are not identical to those of the FSE family. That is why the IEC/IEEE-bus command differs in syntax and data format.*

**Example:** "DIAG:SERV:SFUN '2.0.2.12.1' "

**Characteristics:** \*RST value: -  
SCPI: device-specific

**Mode:** all

**DIAGnostic<1|2>:SERvice:NSOource** ON | OFF

This command switches the 28-V supply of the noise source at the rear panel on or off.

The numeric suffix <1|2> is ignored with this command.

**Example:** "DIAG:SERV:NSO ON"

**Characteristics:** \*RST value: OFF  
SCPI: device-specific

**Mode:** all

**DIAGnostic<1|2>:SERvice:CSOource[:POWer]** <numeric\_value>

This command switches the level of the 128 MHz reference signal source between 0 dBm and -30 dBm in the selected measurement window.

**Example:** "DIAG:SERV:CSO 0DBM"

**Characteristics:** \*RST value: -30 dBm  
SCPI: device-specific

**Mode:** all

**DIAGnostic<1|2>:SERvice:STES:RESult?**

This command reads the results of the selftest out of the instrument. The lines of the result table are output as string data separated by commas:

```
"Total Selftest Status: PASSED", "Date (dd/mm/yyyy): 09/07/1999  
TIME: 16:24:54", "Runtime: 00:06", "..."
```

The numeric suffix <1|2> is ignored with this command.

**Example:** "DIAG:SERV:STES:RES?"

**Characteristics:** \*RST value: --  
SCPI: device-specific

**Mode:** all

# DISPlay Subsystem

The DISPlay subsystem controls the selection and presentation of textual and graphic information as well as of measurement data on the display.

The measurement windows are selected by WINDow1 (screen A) or WINDow2 (screen B) .

COMMAND	PARAMETERS	UNIT	COMMENT
DISPlay			
:FORMat	SINGle SPLit		
:ANNotation			
:FREQuency	<Boolean>		
:LOGO	<Boolean>		
:PSAVe			
[:STATe]	<Boolean>		
:HOLDoff	1 to 60	--	
:CMAP<1 to 32>			
:DEFault<1 2>			
:HSL	0..1,0..1,0..1		
:PDEFined	BLACK   BLUE   BROWN   GREen   CYAN   RED   MAGenta   YELLow   WHITe   DGRAY   LGRAY   LBLUe   LGREen   LCYan   LRED   LMAGenta		
[:WINDow<1 2>]			
:SElect			no query
:TEXT			
[:DATA]	<string>		
:STATe	<Boolean>		
:TIME	<Boolean>		
:TRACe<1 to 3>			
:X			
:SPACing	LINear   LOGarithmic	--	
:Y			
[:SCALE]	<numeric_value>	DB	
:MODE	ABSolute   RELative		
:RLEVel	<numeric_value>	DBM	
:OFFSet	<numeric_value>	DB	
:RVALue	<numeric_value>	DB   Hz	
:RPOSition	<numeric_value>	PCT	
:BOTTom	<numeric_value>	--	
:SPACing	LINear LOGarithmic	--	
:MODE	WRITe VIEW AVERAge  MAXHold MINHold	--	
[:STATe]	<Boolean>		
:BARGraph	CROSSs   OFF		
:LEVel			
:LOWer?			Query only
:UPPer?			Query only

**DISPlay:FORMat** SINGLE | SPLit

This command switches the measurement result display between FULL SCREEN and SPLIT SCREEN. The coupling of settings between screen A and screen B can be selected with the command `INSTRument:COUPle`.

In full-screen display the active measurement window can be selected with `DISPlay:WINDow<1|2>:SElect`.

**Example:** `"DISP:FORM SPL"` 'Switches the display to 2 measurement windows.

**Characteristics:** \*RST value: SINGLE  
SCPI: device-specific

**Mode:** R, A

**DISPlay:ANNOtation:FREQuency** ON | OFF

This command switches the X-axis annotation on or off.

**Example:** `"DISP:ANN:FREQ OFF"`

**Characteristics:** \*RST value: ON  
SCPI: conforming

**Mode:** all

**DISPlay:LOGO** ON | OFF

This command switches the company logo on the screen on or off.

**Example:** `"DISP:LOGO OFF"`

**Characteristics:** \*RST value: ON  
SCPI: device-specific

**Mode:** all

**DISPlay:PSAVe[:STATe]** ON | OFF

This command switches on or off the power-save mode of the display. With the power-save mode activated the display including backlight is completely switched off after the elapse of the response time (see command `DISPlay:PSAVe:HOLDoff`).

**Note:** *This mode is recommended for preserving the display especially if the instrument is exclusively operated via remote control.*

**Example:** `"DISP:PSAVe ON"` 'Switches on the power-save mode.

**Characteristics:** \*RST value: OFF  
SCPI: device-specific

**Mode:** all

**DISPlay:PSAVe:HOLDoff** 1 to 60

This command sets the holdoff time for the power-save mode of the display. The available value range is 1 to 60 minutes, the resolution 1 minute. The entry is dimensionless.

**Example:** `"DISP:PSAV:HOLD 30"`

**Characteristics:** \*RST value: 15  
SCPI: device-specific

**Mode:** all

**DISPlay:CMAP<1 to 32>:DEFAult<1|2>**

This command resets the screen colors of all display items to their default settings. Two default settings DEFault1 and DEFault2 are available. The numeric suffix of CMAP is irrelevant.

**Example:** "DISP:CMAP:DEF2" 'Selects default setting 2 for setting the colors.

**Characteristics:** \*RST value: --  
SCPI: conforming

**Mode:** all

This command is an event and is therefore not assigned a query and has no \*RST value.

**DISPlay:CMAP<1 to 32>:HSL <hue>,<sat>,<lum>**

This command defines the color table of the instrument.

Each numeric suffix of CMAP is assigned one or several graphical elements which can be modified by varying the corresponding color setting. The following assignment applies:

CMAP1 Background  
 CMAP2 Grid  
 CMAP3 Function field + status field + data entry text  
 CMAP4 Function field LED on  
 CMAP5 Function field LED warn  
 CMAP6 Enhancement label text  
 CMAP7 Status field background  
 CMAP8 Trace 1  
 CMAP9 Trace 2  
 CMAP10 Trace 3  
 CMAP11 Marker  
 CMAP12 Lines  
 CMAP13 Measurement status + limit check pass  
 CMAP14 Limit check fail  
 CMAP15 Table + softkey background  
 CMAP16 Table + softkey text  
 CMAP17 Table selected field text  
 CMAP18 Table selected field background  
 CMAP19 Table + data entry field opa q titlebar  
 CMAP20 Data entry field opa q text  
 CMAP21 Data entry field opa q background  
 CMAP22 3D shade bright part  
 CMAP23 3D shade dark part  
 CMAP24 Softkey state on  
 CMAP25 Softkey state data entry  
 CMAP26 Logo  
 CMAP27 Bargraph PK+  
 CMAP28 Bargraph PK-  
 CMAP29 Bargraph Quasi Peak  
 CMAP30 Bargraph Average  
 CMAP31 Bargraph RMS  
 CMAP32 Bargraph Final Measurement

**Parameter:** hue = TINT  
 sat = SATURATION  
 lum = BRIGHTNESS

The value range is 0 to 1 for all parameters.

**Example:** "DISP:CMAP2:HSL 0.3,0.8,1.0" Changes the grid color.

**Characteristics:** \*RST value: --  
SCPI: conforming

**Mode:** all

The values set are not changed by \*RST.



**DISPlay:CMAP<1 to 32>:PDEFined** BLACK | BLUE | BROWn | GREen | CYAN | RED | MAGenta |  
 YELLOW | WHITE | DGRAY | LGRAY | LBLUe | LGREEN | LCYan  
 | LRED | LMAGenta

This command defines the color table of the instrument using predefined color values. Each numeric suffix of CMAP is assigned one or several graphical elements which can be modified by varying the corresponding color setting.

The same assignment as for DISPlay:CMAP<1 to 32>:HSL applies.

**Example:** "DISP:CMAP2:PDEF GRE"

**Characteristics:** \*RST value: --  
 SCPI: conforming

**Mode:** all

The values set are not changed by \*RST.

### DISPlay[:]WINDow<1|2>:SELEct

This command selects the active measurement window. WINDow1 corresponds to SCREEN A, WINDow2 to SCREEN B.

In FULL SCREEN mode, the measurements are only performed in the active measurement window. Measurements are therefore initiated in the active window and result queries (marker, trace data and other results) answered also in the active window.

Initiating measurements and querying results in the inactive window yields an error message (execution error).

In split screen mode, the selection of the active window for result queries is irrelevant.

**Note:** - In FULL SCREEN mode, settings can also be performed in the inactive measurement window. They become effective as soon as the corresponding window becomes active.

**Example:** "DISP:WIND2:SEL 'Selects SCREEN B as active measurement window."

**Characteristics:** \*RST value: SCREEN A active  
 SCPI: device-specific

**Mode:** A

This command is an event and is therefore not assigned a query.

### DISPlay[:]WINDow<1|2>:TEXT[:DATA] <string>

This command defines a comment (max. 20 characters) which can be displayed on the screen in the selected measurement window.

**Example:** "DISP:WIND2:TEXT 'Noise Measurement'"  
 'Defines the title for screen B

**Characteristics:** \*RST value: "" (empty)  
 SCPI: conforming

**Mode:** all

**DISPlay[:WINDow<1|2>]:TEXT:STATe** ON | OFF

This command switches on or off the display of the comment (screen title) in the selected measurement window.

**Example:** "DISP:TEXT:STAT ON" 'Switches on the title of screen B.

**Characteristics:** \*RST value: OFF  
SCPI: conforming

**Mode:** all

**DISPlay[:WINDow<1|2>]:TIME** ON | OFF

This command switches on or off the screen display of date and time. The numeric suffix in WINDow<1|2> is irrelevant.

**Example:** "DISP:TIME ON"

**Characteristics:** \*RST value: OFF  
SCPI: device-specific

**Mode:** all

**DISPlay[:WINDow<1|2>]:TRACe<1 to 3>:X:SPACing** LINear | LOGarithmic

This command toggles between linear and logarithmic display in receiver mode

**Example:** "DISP:TRAC:X:SPAC LIN"

**Features:** \*RST value: LOGarithmic  
SCPI: conforming

**Modes:** R,

The numeric suffix in TRACe<1 to 3> is irrelevant.

**DISPlay[:WINDow<1|2>]:TRACe<1 to 3>:Y[:SCALe]** 1dB to 200dB

This command defines the display range of the Y-axis (level axis) in the selected measurement window with logarithmic scaling (DISP:TRAC:Y:SPAC LOG).

For linear scaling, (DISP:TRAC:Y:SPAC LIN | PERC) the display range is fixed and cannot be modified. The numeric suffix in TRACe<1 to 3> is irrelevant.

The Minimum value is 1 dB for SPECTRUM mode, and 10 dB for RECEIVER mode.

**Example:** "DISP:TRAC:Y 110dB"

**Characteristics:** \*RST value: 100dB  
SCPI: device-specific

**Mode:** all

**DISPlay[:WINDow<1|2>]:TRACe<1 to 3>:Y[:SCALe]:MODE** ABSolute | RELative

This command defines the scale type of the Y-axis (absolute or relative) in the selected measurement window.

When SYSTem:DISPlay is set to OFF, this command has no immediate effect on the screen. The numeric suffix in TRACe<1 to 3> is irrelevant.

**Example:** "DISP:TRAC:Y:MODE REL"

**Characteristics:** \*RST value: ABS  
SCPI: device-specific

**Mode:** A

**DISPlay[:WINDow<1|2>]:TRACe<1 to 3>:Y[:SCALe]:RLEVEL** -130dBm to 30dBm

This command defines the reference level in the selected measurement window. Depending on the coupling of the measurement windows, it is valid for both screens (`INSTRument:COUPLe ALL`) or only for the selected measurement window (`INSTRument:COUPLe NONE`).

With the reference level offset  $\neq 0$  the indicated value range of the reference level is modified by the offset.

The unit depends on the setting defined with `CALCulate:UNIT`. The numeric suffix in `TRACe<1 to 3>` is irrelevant.

**Example:** `"DISP:TRAC:Y:RLEV -60dBm"`

**Characteristics:** \*RST value: -20dBm  
SCPI: conforming

**Mode:** A

**DISPlay[:WINDow<1|2>]:TRACe<1 to 3>:Y[:SCALe]:RLEVEL:OFFSet** -200dB to 200dB

This command defines the offset of the reference level in the selected measurement window.

Depending on the coupling of the measurement windows, it is valid for both screens (`INSTRument:COUPLe ALL`) or only for the selected measurement window (`INSTRument:COUPLe NONE`). The numeric suffix at `TRACe<1 to 3>` is irrelevant.

**Example:** `"DISP:TRAC:Y:RLEV:OFFS -10dB"`

**Characteristics:** \*RST value: 0dB  
SCPI: conforming

**Mode:** A

**DISPlay[:WINDow<1|2>]:TRACe<1 to 3>:Y[:SCALe]:RVALue** <numeric\_value>

If the tracking generator option or the external generator control option (FSP-B9/B10) is mounted and the normalization in the NETWORK mode is activated, this value defines the power value assigned to the reference position in the selected measurement window. This value corresponds to the parameter REFERENCE VALUE in manual operation. The numeric suffix at `TRACe<1 to 3>` is irrelevant.

**Example:** `"DISP:TRAC:Y:RVAL 0"` sets the power value assigned to the reference position to 0 dB.

**Characteristics:** \*RST value: 0 dB  
SCPI: device specific

**Modes:** A

**DISPlay[:WINDow<1|2>]:TRACe<1 to 3>:Y[:SCALe]:RPOSition** 0 to 100PCT

This command defines the position of the reference value in the selected measurement window. The numeric suffix in `TRACe<1 to 3>` is irrelevant.

In operating mode NETWORK (Tracking Generator /Ext. Generator Option FSP-B9/B10) with active normalization, RPOSition defines the reference point for the output of the normalized measurement results.

**Example:** `"DISP:TRAC:Y:RPOS 50PCT"`

**Characteristics:** \*RST value: 100PCT (SPECTRUM mode)  
50 PCT (NETWORK mode)  
SCPI: conforming

**Mode:** A

**DISPlay[:WINDow<1|2>]:TRACe<1 to 3>:Y[:SCALE]:BOTTom** <numeric\_value>

This command defines the minimum grid level in the current unit for the scan display in the receiver mode.

**Example:** "DISP:TRAC:Y:BOTT -20" The minimum grid level is set to -20 dBuV (pre-condition: the default unit has not been changed)

**Characteristics:** \*RST value: 0  
SCPI: conforming

**Mode:** R

The numeric suffix in TRACE<1 to 3> is irrelevant.

**DISPlay[:WINDow<1|2>]:TRACe<1 to 3>:Y:SPACing** LINear | LOGarithmic

This command toggles between linear and logarithmic display in the selected measurement window.. The numeric suffix in TRACE<1 to 3> is irrelevant.

**Example:** "DISP:TRAC:Y:SPAC LIN"

**Characteristics:** \*RST value: LOGarithmic  
SCPI: conforming

**Mode:** A

**DISPlay[:WINDow<1|2>]:TRACe<1 to 3>:MODE** WRITe | VIEW | AVERAge | MAXHold | MINHold

This command defines the type of display and the evaluation of the traces in the selected measurement window. WRITE corresponds to the Clr/Write mode of manual operation. The trace is switched off (= BLANK in manual operation) with DISP:WIND:TRAC:STAT OFF.

The number of measurements for AVERAge, MAXHold and MINHold is defined with the command SENSE:AVERAge:COUNT or SENSE:SWEep:COUNT. It should be noted that synchronization to the end of the indicated number of measurements is only possible in single sweep mode.

If calculation of average values is active, selection between logarithmic and linear averaging is possible. For more detail see command SENSE:AVERAge:TYPE.

**Example:** "SWE:CONT OFF" Switching to single-sweep mode.  
"SWE:COUN 16" Sets the number of measurements to 16.  
"DISP:WIND1:TRAC3:MODE MAXH" Switches on the calculation of the for 'trace 3 in screen A.  
"INIT;\*WAI" Starts the measurement and waits for the end of the '16 sweeps.

**Characteristics:** \*RST value: WRITe for TRACe1, STATe OFF for TRACe2/3  
SCPI: device-specific

**Mode:** all

**DISPlay[:WINDow<1|2>]:TRACe<1 to 3>[:STATe]** ON | OFF

This command switches on or off the display of the corresponding trace in the selected measurement window.

**Example:** "DISP:WIND1:TRAC3 ON"

**Characteristics:** \*RST value: ON for TRACe1, OFF for TRACe2 to 4  
SCPI: conforming

**Mode:** all

**DISPlay:WINDow<1|2>:TRACe<1 to 3>:SYMBol CROsS | OFF**

This command switches on or off the indication of the peak list or the final measurement result on the trace.

CROsS                    The single value is indicated as x.

OFF                      No indication.

**Example:**                "DISP:TRAC:SYMB CROsS"

**Features:**                \*RST value:    OFF  
                              SCPI:            device-specific

**Mode:**                    R

**DISPlay:BARGraph:LEVel:LOWer?**

This command queries the minimum level of the bar graph.

**Example:**                "DISP:BARG:LEV:LOW?"

**Features:**                \*RST value:    --  
                              SCPI:            device-specific

**Mode:**                    R

**DISPlay:BARGraph:LEVel:UPPer?**

This command queries the maximum level of the bar graph.

**Example:**                "DISP:BARG:LEV:UPP?"

**Features:**                \*RST value:    --  
                              SCPI:            device-specific

**Mode:**                    R

## FORMat Subsystem

The FORMat subsystem specifies the data format of the data transmitted from and to the instrument.

COMMAND	PARAMETERS	UNIT	COMMENT
FORMat [:DATA] :DEXPort :DSEParator	ASCIi REAL[,<numeric_value>]  POINt COMMa	-	

### FORMat[:DATA] ASCii | REAL[, 32]

This command specifies the data format for the data transmitted from the instrument to the control PC.

**Example:** "FORM REAL, 32"  
"FORM ASC"

**Characteristics:** \*RST value: ASCII  
SCPI: conforming

**Mode:** all

The data format is either ASCII or one of the formats REAL. ASCII data are transmitted in plain text, separated by commas. REAL data are transmitted as 32-bit IEEE 754 floating-point numbers in the "definite length block format".

The FORMat command is valid for the transmission of trace data. The data format of trace data received by the instrument is automatically recognized, regardless of the format which is programmed.

Format setting for the binary transmission of trace data (see also TRACE:DATA?):

Analyzer mode: REAL, 32

### FORMat:DEXPort:DSEParator POINt|COMMA

This command defines which decimal separator (decimal point or comma) is to be used for outputting measurement data to the file in ASCII format. Different languages of evaluation programs (eg MS-Excel) can thus be supported.

**Example:** "FORM:DEXP:DSEP POIN" 'Sets the decimal point as separator.

**Characteristics:** \*RST value: -- (factory setting is POINt; \*RST does not affect setting)  
SCPI: device-specific

**Mode:** all

# HCOPY Subsystem

The HCOpy subsystem controls the output of display information for documentation purposes on output devices or files. The instrument allows two independent printer configurations which can be set separately with the numeric suffix <1|2>.

COMMAND	PARAMETERS	UNIT	COMMENT
HCOPY			
:ABORt	--	--	no query
:CMAp<1 to 32>			
:DEFault<1 2 3>			
:HSL	0..1,0..1,0..1		
:PDEFined	BLACK   BLUE   BROWN   GREEN   CYAN   RED   MAGenta   YELLOW   WHITE   DGRAY   LGRAY   LBLUE   LGREEN   LCYan   LRED   LMAGenta		
:DESTination<1 2>	<string>		no query
:DEVice			
:COLor	<Boolean>		
:LANGuage<1 2>	WMF  GDI EWMF BMP		
[:IMMediate<1 2>]	--	--	no query
:ITEM			
:ALL			no query
:WINDow<1 2>			
:TABLE			
:STATe	<Boolean>		
:TEXT	<string>		
:TRACe			
:STATe	<Boolean>		
:PAGE			
:ORientation<1 2>	LANDscape PORTRait		

## HCOPY:ABORt

This command aborts a running hardcopy output.

**Example:** "HCOP : ABOR "

**Characteristics:** \*RST value: -  
SCPI: conforming

**Mode:** all

This command is an event and is therefore not assigned an \*RST value and has no query.

## HCOPY:CMAp<1 to 32>:DEFault1|2|3

This command resets the colors for a hardcopy to the selected default settings. DEFault1 (SCREEN COLORS, but background white), DEFault2 (OPTIMIZED COLOR SET) and DEFault3 (USER DEFINED). The numeric suffix in CMAP is not significant.

**Example:** "HCOP : CMAP : DEF 2 " 'selects OPTIMIZED COLOR SET for the color settings of a hardcopy.

**Features:** \*RST value: --  
SCPI: conforming

**Modes:** all

This command is an event and has thus no query and no \*RST value assigned.

**HCOPY:CMAP<1 to 32>:HSL <hue>,<sat>,<lum>**

This command defines the color table in USER DEFINED COLORS mode.

To each numeric suffix of CMAP is assigned one or several picture elements which can be modified by varying the corresponding color setting. The following assignment applies:

CMAP1	Background
CMAP2	Grid
CMAP3	Function field + status field + data entry text
CMAP4	Function field LED on
CMAP5	Function field LED warn
CMAP6	Enhancement label text
CMAP7	Status field background
CMAP8	Trace 1
CMAP9	Trace 2
CMAP10	Trace 3
CMAP11	Marker
CMAP12	Lines
CMAP13	Measurement status + Limit check pass
CMAP14	Limit check fail
CMAP15	Table + softkey background
CMAP16	Table + softkey text
CMAP17	Table selected field text
CMAP18	Table selected field background
CMAP19	Table + data entry field opaq titlebar
CMAP20	Data entry field opaq text
CMAP21	Data entry field opaq background
CMAP22	3D shade bright part
CMAP23	3D shade dark part
CMAP24	Softkey state on
CMAP25	Softkey state data entry
CMAP26	Logo
CMAP27	Bargraph PK+
CMAP28	Bargraph PK-
CMAP29	Bargraph Quasi Peak
CMAP30	Bargraph Average
CMAP31	Bargraph RMS
CMAP32	Bargraph Final Measurement

**Parameter:** hue = tint  
sat = saturation  
lum = brightness

The value range is 0 to 1 for all parameters

**Example:** "HCOPY:CMAP2:HSL 0.3,0.8,1.0" ' changes the grid color

**Features:** \*RST value: --  
SCPI: conforming

**Modes:** all

The values set are not changed by \*RST.





**HCOPY:DEVIce:COLor ON|OFF**

This command selects between color and monochrome hardcopy of the screen.

**Example:** "HCOP:DEV:COL ON"

**Characteristics:** \*RST value: OFF  
SCPI: conforming

**Mode:** all

**HCOPY:DEVIce:LANGUage<1|2> GDI | WMF | EWMF | BMP**

This command determines the data format of the printout.

<b>Parameter:</b>	GDI	Graphics Device Interface: Default format for the output to a printer configured under Windows. Must be selected for the output to the printer interface (HCOPY:DEVIce 'SYST:COMM:PRIN'). Can be used for the output to a file (HCOPY:DEVIce 'SYST:COMM:MMEM'). The printer driver configured under Windows is used in this case and a printer-specific file format is thus generated.
	WMF and EWMF	WINDOWS Metafile and Enhanced Metafile Format: Data formats for output files which can be integrated in corresponding programs for documentation purposes at a later time. WMF can only be used for output to a file (HCOPY:DEVIce 'SYST:COMM:MMEM') and EWMF also for the output to the clipboard (HCOPY:DEVIce 'SYST:COMM:CLIP').
	BMP	Bitmap. Data format for output to files only (HCOPY:DEVIce 'SYST:COMM:MMEM').

**Example:** "HCOP:DEV:LANG WMF"

**Characteristics:** \*RST value: -  
SCPI: conforming

**Mode:** all

**HCOPY[:IMMEDIATE<1|2>]**

This command starts a hardcopy output. The numeric suffix selects which printer configuration (1 or 2) is to be used for the hardcopy output. If there is no suffix, configuration 1 is automatically selected.

HCOPY:IMM[1] 'Starts the hardcopy output to device 1 (default).  
HCOPY:IMM2 'Starts the output to device 2.

**Example:** "HCOP"

**Characteristics:** \*RST value: -  
SCPI: conforming

**Mode:** all

This command is an event and is therefore not assigned an \*RST value and has no query.

**HCOPY:ITEM:ALL**

This command selects the complete screen to be output.

**Example:** "HCOP:ITEM:ALL"

**Characteristics:** \*RST value: OFF  
SCPI: conforming

**Mode:** all

The hardcopy output is always provided with comments, title, time and date. As an alternative to the whole screen, only traces (commands 'HCOPY:DEVICE:WINDOW:TRACE:STATE ON') or tables (command 'HCOPY:DEVICE:WINDOW:TABLE:STATE ON') can be output.

**HCOPY:ITEM:WINDOW<1|2>:TABLE:STATE ON | OFF**

This command selects the output of the currently displayed tables.

**Example:** "HCOP:ITEM:WIND:TABLE:STAT ON"

**Characteristics:** \*RST value: OFF  
SCPI: device-specific

**Mode:** all

The command HCOPIY:DEVICE:ITEM:WINDOW<1|2>:TABLE:STATE OFF as well as command HCOPIY:DEVICE:ITEM:ALL enables the output of the whole screen.

**HCOPY:ITEM:WINDOW<1|2>:TEXT <string>**

This command defines the comment text for measurement window 1 or 2 for printout, with a maximum of 100 characters; line feed by means of character @).

**Example:** "HCOP:ITEM:WIND2:TEXT 'comment' "

**Characteristics:** \*RST value: -  
SCPI: device-specific

**Mode:** all

**HCOPY:ITEM:WINDOW<1|2>:TRACE:STATE ON | OFF**

This command selects the output of the currently displayed trace.

**Example:** "HCOP:ITEM:WIND:TRACE:STAT ON"

**Characteristics:** \*RST value: OFF  
SCPI: device-specific

**Mode:** all

The command HCOPIY:ITEM:WINDOW<1|2>:TRACE:STATE OFF as well as command HCOPIY:ITEM:ALL enables the output of the whole screen.

**HCOPY:PAGE:ORIENTATION<1|2> LANDscape | PORTrait**

The command selects the format of the output (portrait and landscape) (hardcopy unit 1 or 2).

**Note:**

*The command is only available provided that the output device "printer" (HCOP:DEST 'SYST:COMM:PRIN') has been selected.*

**Example:** "HCOP:PAGE:ORI LAND"

**Characteristics:** \*RST value: -  
SCPI: conforming

**Mode:** all

## INITiate Subsystem

The INITiate subsystem is used to control the init-measurement function in the selected measurement window. In receiver mode, a distinction is made between single measurement (INITiate1) and scan (INITiate2). In signal analyzer mode, a distinction is made between INITiate1 (screen A) and INITiate2 (screen B) in split screen representation.

COMMAND	PARAMETERS	UNIT	COMMENT
INITiate<1 2>			
:CONTInuous	<boolean>	--	
:CONMeas	--	--	no query
[:IMMediate]	--	--	no query
:DISPlay	<boolean>	--	

### INITiate<1|2>:CONTInuous ON | OFF

This command determines whether the trigger system is continuously initiated (continuous) or performs single measurements (single).

Setting "INITiate:CONTInuous ON" corresponds to function SCAN/SWEEP CONTInuous, ie the scan/sweep of the receiver/analyzer is cyclically repeated. The setting "INITiate:CONTInuous OFF" corresponds to function SCAN/SWEEP SINGLE..

**Example:**

```
" INIT2:CONT OFF " 'Switches the sequence in screen B to single
                        'scan/sweep.
" INIT2:CONT ON " 'Switches the sequence to continuous scan/sweep.
```

**Characteristics:** \*RST value: ON  
SCPI: conforming

**Mode:** all

### INITiate<1|2>:CONMeas

This command continues an aborted scan measurement at the current receiver frequency.

This command continues a stopped measurement at the current position in single sweep mode. The function is useful especially for trace functions MAXHold, MINHold and AVERage if the previous results are not to be cleared with Sweep Count > 0 or Average Count > 0 on restarting the measurement (INIT:IMMediate resets the previous results on restarting the measurement).

The single-sweep mode is automatically switched on. Synchronization to the end of the indicated number of measurements can then be performed with the command \*OPC, \*OPC? or \*WAI. In the continuous-sweep mode, synchronization to the sweep end is not possible since the overall measurement "never" ends.

**Example:**

```
" INIT:CONT OFF " 'Switches to single-sweep mode.
" DISP:WIND:TRAC:MODE AVER " 'Switches on trace averaging.
" SWE:COUN 20 " 'Setting the sweep counter to 20 sweeps.
" INIT;*WAI " 'Starts the measurement and waits for the
                'end of the 20 sweeps.
" INIT:CONM;*WAI " 'Continues the measurement (next 20
                    'sequences) and waits for the end.
```

**Characteristics:** \*RST value: -  
SCPI: device-specific

**Mode:** R, A

This command is an event and therefore has no \*RST value and has no query.

**INITiate<1|2>[:IMMEDIATE]**

The command initiates a new sweep in the indicated measurement window.

In receiver mode with *SINGLE* selected, ESPI performs a single scan and stops at the end frequency. With *CONTINUOUS* selected, the scan is performed continuously until it is deliberately stopped.

In analyzer mode, with Sweep Count > 0 or Average Count > 0, this means a restart of the indicated number of measurements. With trace functions MAXHold, MINHold and AVERage, the previous results are reset on restarting the measurement.

In single sweep mode, synchronization to the end of the indicated number of measurements can be achieved with the command \*OPC, \*OPC? or \*WAI. In continuous-sweep mode, synchronization to the sweep end is not possible since the overall measurement never ends.

**Example:**

"INIT:CONT OFF"	'Switches to single-sweep mode.
"DISP:WIND:TRAC:MODE AVER"	'Switches on trace averaging.
"SWE:COUN 20"	Setting the sweep counter to 20 sweeps.
"INIT;*WAI"	'Starts the measurement and waits for the end of the 20 sweeps.

**Characteristics:** \*RST value: -  
SCPI: conforming

**Mode:** all

This command is an event and is therefore not assigned an \*RST value and has no query.

**INITiate<1|2>:DISPlay ON | OFF**

This command configures the behavior of the display during a single sweep.

INITiate:DISPlay OFF means that the display is switched off during the measurement,

INITiate:DISPlay ON means that the display is switched on during the measurement.

The numeric suffix of INITiate is irrelevant with this command.

**Example:**

"INIT:CONT OFF"	'Switches to single-sweep mode
"INIT:DISP OFF"	'Sets the display behavior to OFF
"INIT;*WAI"	'Starts the measurement with display switched off.

**Characteristics:** \*RST value: ON  
SCPI: device-specific

**Mode:** A

# INPut Subsystem

The INPut subsystem controls the input characteristics of the RF inputs of the instrument. In receiver mode, the suffix is irrelevant. In the analyzer mode, the measurement windows are assigned to INPut1 (screen A) and INPut2 (screen B).

COMMAND	PARAMETERS	UNIT	COMMENT
INPut<1 2>			
:ATTenuation	<numeric_value>	DB	
:AUTO	<Boolean>	--	
:PROTection [:STATe]	<Boolean>	--	
:LISN [:TYPE]	TWOPhase   FOURphase   OFF		
:PHASe	L1   L2   L3   N		
:PEARth	GROunded   FLOating		
:UPORt [:VALue?]	--	--	Query only
:STATe	<Boolean>	--	
:IMPedance	50   75	OHM	
:GAIN :STATe	<Boolean>		Only with option ESPI-B2
:AUTO	<Boolean>		
:PRESelection [:STATe]	<Boolean>		

## INPut<1|2>:ATTenuation 0 to 70 dB

This command programs the input attenuator. To protect the input mixer against damage from overloads, the setting 0 dB can be obtained by entering numerals, not by using the command DEC.

In the default state with analyzer mode, the attenuation set on the step attenuator is coupled to the reference level of the instrument. If the attenuation is programmed directly, the coupling to the reference level is switched off.

With receiver mode, if the attenuation is programmed directly, the auto range function is switched off if necessary. Setting 0 db can be prevented by activating the protection function (INPut:ATTenuation:PROTection ON).

**Example:** "INP:ATT 40dB" 'Sets the attenuation on the attenuator to 40 dB and 'switches off the coupling to the reference level.

**Characteristics:** \*RST value: 10 dB (AUTO is set to ON)  
SCPI: conforming

**Mode:** all

**INPut<1|2>:ATTenuation:AUTO ON | OFF**

In analyzer mode, this command automatically couples the input attenuation to the reference level (state ON) or switches the input attenuation to manual entry (state OFF). The minimum input attenuation set with the coupling switched on is 10 dB.

In receiver mode, this command automatically sets the attenuation so that a good S/N ratio is obtained without the receiver stages being overdriven (state ON).

**Example:** "INP:ATT:AUTO ON" ' Couples the attenuation set on the attenuator to the 'reference level.

**Characteristics:** \*RST value: ON  
SCPI: conforming

**Mode:** all

**INPut<1|2>:ATTenuation:PROTection ON | OFF**

This command defines whether the 0 dB position of the attenuator is to be used in manual or automatic adjustment.

**Example:** "INP:ATT:PROT ON"

**Characteristics:** \*RST value: OFF  
SCPI: device-specific

**Mode:** R

**INPut<1|2>:LISN[:TYPE] TWOPhase | FOURphase | OFF**

This command selects the V-network to be controlled via the user port:

TWOPhase = Two-line V-network ESH3-Z5

FOURphase = Four-line V-network ESH2-Z5 oder ENV4200

OFF = remote control is deactivated

**Example:** "INP:LISN:TWOP"

**Features:** \*RST value: OFF  
SCPI: device specific

**Mode:** R, A

**INPut<1|2>:LISN:PHASe L1 | L2 | L3 | N**

This command selects the phase of the V-network on which the RFI voltage is to be measured.

**Example:** "INP:LISN:PHAS L1"

**Features:** \*RST value: L1  
SCPI: device specific

**Mode:** R, A

**INPut<1|2>:LISN:PEARth GROunded | FLOating**

This command selects the setting of the protection earth of the V-network.

**Example:** "INP:LISN:PEAR GRO"

**Features:** \*RST value: GROunded  
SCPI: device specific

**Mode:** R, A

**INPut<1|2>:UPORt[:VALue]?**

This command queries the control lines of the user ports.

**Example:** "INP:UPOR?"

**Characteristics:** \*RST value: -  
SCPI: device-specific

**Modes:** all

This command is a query command and is therefore not assigned an \*RST value.

**INPut<1|2>:UPORt:STATe ON | OFF**

This command toggles the control lines of the user ports between INPut and OUTPut.

**Example:** "INP:UPOR:STAT ON"

**Characteristics:** \*RST value: ON  
SCPI: device-specific

**Modes:** all

With ON, the user port is switched to INPut, with OFF to OUTPut.

**INPut<1|2>:IMPedance 50 | 75**

This command sets the nominal input impedance of the instrument. The set impedance is taken into account in all level indications of results..

The setting 75  $\Omega$  should be selected, if the 50  $\Omega$  input impedance is transformed to a higher impedance using a 75  $\Omega$  adapter of the RAZ type (= 25  $\Omega$  in series to the input impedance of the instrument). The correction value in this case is 1.76 dB = 10 log ( 75 $\Omega$  / 50 $\Omega$ ).

**Example:** "INP:IMP 75"

**Characteristics:** \*RST value: 50  $\Omega$   
SCPI: conforming

**Mode:** A

**INPut<1|2>:GAIN:STATe ON | OFF**

This command switches on the preamplifier for the instrument. The switchable gain is fixed to 20 dB.

In analyzer mode, the command is only available, if the preselector measurement has been activated.

**Example:** "INP:GAIN ON" 'Switches on 20 dB preamplification

**Characteristics:** \*RST value: OFF  
SCPI: conforming

**Modes:** R, A

The command is only available with the option preselector, ESPI-B2.



**INPut<1|2>:GAIN:AUTO ON | OFF**

This command includes the preamplifier into the autoranging function of the receiver.

**Example:** "INP:GAIN:AUTO ON" ' Includes the preamplifier into the auto range function

**Characteristics:** \*RST value: OFF  
SCPI: conforming

**Mode:** R

**INPut<1|2>:PRESelection[:STATe] ON | OFF**

In analyzer mode, this command switches the preselection on or off.

**Example:** "INP:PRES:STAT ON"

**Characteristics:** \*RST value: OFF  
SCPI: device-specific

**Modes:** A

## INSTrument Subsystem

The INSTrument subsystem selects the operating mode of the unit either via text parameters or fixed numbers.

COMMAND	PARAMETERS	UNIT	COMMENT
INSTrument [:SElect] :NSElect :COUPle	SANalyzer   RECeiver <numeric_value> NONE   RLEVel   CF_B   CF_A		no query

### INSTrument[:SElect] SANalyzer | RECeiver

This command switches between the operating modes by means of text parameters.

**Parameter:** SANalyzer: Spectrum analysis  
RECeiver: EMI receiver

**Example:** "INST SAN" 'Switches the instrument to *SPECTRUM*.

**Characteristics:** \*RST value: RECeiver  
SCPI: conforming

**Mode:** all

### INSTrument:NSElect 1 | 6

This command switches between the operating modes by means of numbers.

**Parameter:** 1: Spectrum analysis  
6: EMI receiver

**Example:** "INST:NSEL 1" 'Switches the instrument to *SPECTRUM*.

**Characteristics:** \*RST value: 1  
SCPI: conforming

**Mode:** all

### INSTrument:COUPle NONE | RLEVel | CF\_B | CF\_A

In operating mode *SPECTRUM* this command selects the parameter coupling between the two measurement windows screen A and B.

**Parameter:** NONE No coupling. The two measurement windows are operated like two independent "virtual" devices.  
RLEVel The reference levels of the two measurement windows are coupled.  
CF\_B The center frequency of screen B is coupled to the frequency of marker 1 in screen A.  
CF\_A The center frequency of screen A is coupled to the frequency of marker 1 in screen B.

**Example:** "INST:COUP NONE" 'Switches off the coupling of measurement windows.  
'This leads to two independent "virtual" devices.

**Characteristics:** \*RST value: NONE  
SCPI: device specific

**Mode:** A

## MMEMory Subsystem

The MMEMory (mass memory) subsystem provides commands which allow for access to the storage media of the instrument and for storing and loading various instrument settings.

The various drives can be addressed via the "mass storage unit specifier" <msus> using the conventional DOS syntax. The internal hard disk is addressed by "D:", the floppy-disk drive by "A:".

**Note:** *For reasons of compatibility with the FSE instruments, addressing the hard disk by "C:" is also accepted. Since hard disk "C:" is reserved for instrument software, all read and write operations are rerouted to hard disk "D:" in normal operation (service level0).*

The file names <file\_name> are indicated as string parameters with the commands being enclosed in quotation marks. They also comply with DOS conventions.

DOS file names consist of max. 8 ASCII characters and an extension of up to three characters separated from the file name by a dot "." Both, the dot and the extension are optional. The dot is not part of the file name. DOS file names do not distinguish between uppercase and lowercase notation. All letters and digits are permitted as well as the special characters "\_", "^", "\$", "~", "!", "#", "%", "&", "-", "{", "}", "(", ")", "@", and "'". Reserved file names are CLOCK\$, CON, AUX, COM1 to COM4, LPT1 to LPT3, NUL and PRN.

The two characters "\*" and "?" have the function of so-called "wildcards", i.e., they are variables for selection of several files. The question mark "?" replaces exactly one character, the asterisk means any of the remaining characters in the file name. "\*.\*" thus means all files in a directory.

COMMAND	PARAMETERS	UNIT	COMMENT
MMEMemory			
:CATalog?	<string>		
:CDIRectory	<directory_name>	--	
:COPY	<file_name>,<file_name>	--	no query
:DATA	<file_name>[,<block>]	--	
:DElete	<file_name>	--	no query
:INITialize	<msus>	--	no query
:LOAD			
:STATe	1,<file_name>	--	no query
:AUTO	1,<file_name>	--	no query
:MDIRectory	<directory_name>	--	no query
:MOVE	<file_name>,<file_name>	--	no query
:MSIS	<msus>	--	
:NAME	<file_name>	--	
:RDIRectory	<directory_name>	--	no query
:STORE<1 2>			
:STATe	1,<file_name>	--	no query
:TRACe	<numeric_value>,<file_name>		
:FINal	<file_name>		no query
:CLEar			
:STATe	1,<file_name>	--	no query
:ALL			no query
:SElect			
[:ITEM]			
:HWSettings	<Boolean>		
:TRACe			
[:ACTive]	<Boolean>		
:LINes			
:ALL	<Boolean>		
:SCData	<Boolean>		Tracking generator option
:TRANsducer			
[:ACTive]	<Boolean>		
:ALL	<Boolean>		
:FINal	<Boolean>		
:ALL	--		no query
:NONE	--		no query
:DEFault	--		no query
:COMMeNT	<string>		

**MMEemory:CATalog?** <path>

This command reads the indicated directory. According to DOS convention, wild card characters can be entered in order to query eg a list of all files of a certain type.

The path name should be in conformance with DOS conventions and may also include the drive name.

**Parameter:** <path>::= DOS Path name

**Example:** "MMEemory:CAT? 'D:\USER\DATA' 'Returns the contents of the 'D:\USER\DATA directory  
 "MMEemory:CAT? 'D:\USER\DATA\\*.LOG' 'Returns all files in D:\USER\DATA 'with extension ".LOG"  
 "MMEemory:CAT? 'D:\USER\DATA\SPOOL?.WMF' ' Returns all files in D:\USER\DATA whose 'names start with SPOOL, have 6 letters 'and the extension ".WMF".

**Response value:** List of file names in the form of strings separated by commas, ie 'SPOOL1.WMF', 'SPOOL2.WMF', 'SPOOL3.WMF'

**Characteristics:** \*RST value: -  
 SCPI: conformal

**Operating mode:** all

**MMEemory:CDIRectory** <directory\_name>

This command changes the current directory.

In addition to the path name, the indication of the directory may contain the drive name. The path name complies with the DOS conventions.

**Parameter:** <directory\_name>::= DOS path name

**Example:** "MMEemory:CDIR 'D:\USER\DATA' " 'Returns the list of files in directory 'D:\USER\DATA.

**Characteristics:** \*RST value: -  
 SCPI: conforming

**Mode:** all

**MMEemory:COPY** <file\_source>,<file\_destination>

This command copies the files indicated in <file\_source> to the destination directory indicated with <file\_destination> or to the destination file indicated by <file\_destination> when <file\_source> is just a file.

The indication of the file name may include the path and the drive name. The file names and path information must be in accordance with the DOS conventions.

**Parameter:** <file\_source>,<file\_destination> ::= <file\_name>  
 <file\_name> ::= DOS file name

**Example:** "MMEemory:COPY 'D:\USER\DATA\SETUP.CFG', 'A:' "

**Characteristics:** \*RST value: -  
 SCPI conforming

**Mode:** all

This command is an event and is therefore not assigned an \*RST value and has no query.

**MMEMory:DATA** <file\_name>[,<block data>]

This command writes the block data contained in <block> into the file characterized by <file\_name>. The IEC/IEEE-bus delimiter must be set to EOI to obtain error-free data transfer.

The associated query command reads the indicated file from the mass memory and transfers it to the control computer via the IEC/IEEE bus. It should be noted that the buffer memory of the control computer should be large enough to store the file. The setting of the IEC/IEEE-bus delimiter is irrelevant in this case.

The command is useful for reading stored device settings or trace data from the instrument or for transferring them to the instrument.

**Syntax:** MMEMory:DATA <file\_name>,<block data> Data transfer from control computer to instrument.

MMEMory:DATA? <file\_name> Data transfer from instrument to control computer.

<file\_name> selects the file to be transferred.

The binary data block <block> has the following structure:

- it always begins with the character '#',
- followed by a digit for the length of the length information,
- followed by the indicated number of digits as length information (number of bytes) for the binary data themselves,
- finally the binary data with the indicated number of bytes

**Example:** "MMEM:DATA 'TEST01.HCP', #217This is the file"  
 ' means:  
 '#2: the next 2 characters  
 ' are the length indication  
 '17: number of subsequent binary data  
 ' bytes  
 'This is the file:  
 ' 17 bytes stored as binary data in the  
 ' file TEST01.HCP.

"MMEM:DATA? 'TEST01.HCP' " ' Transfers the file TEST01.HCP from the  
 'instrument to the control computer.

**Characteristics:** \*RST value: -  
 SCPI: conforming

**Mode:** all

**MMEMemory:DELeTe** <file\_name>

This command deletes the indicated files.

The indication of the file name contains the path and, optionally, the drive name. Indication of the path complies with DOS conventions.

**Parameter:** <file\_name> ::= DOS file name

**Example:** "MEM:DEL 'TEST01.HCP' " ' The file TEST01.HCP is deleted.

**Characteristics:** \*RST value: -  
SCPI: conforming

**Mode:** all

This command is an event and is therefore not assigned an \*RST value and has no query.

**MMEMemory:INITialize** 'A:'

This command formats the disk in drive A. Formatting deletes all data stored on the floppy disk.

**Parameter:** <msus> ::= 'A:'  
Only drive name A: is accepted.

**Example:** "MEM:INIT 'A:' "

**Characteristics:** \*RST value: -  
SCPI: conforming

**Mode:** all

This command is an event and is therefore not assigned an \*RST value and has no query.

**MMEMory:LOAD:STATE 1,<file\_name>**

This command loads device settings from files. The contents of the file are loaded and set as the new device state. The device automatically recognizes the files that are required for the whole setup from the list of file extensions:

Contents	Extension
Current setting of measurement hardware and associated title, if indicated	.SET
Activated limit lines	.LIN
Current configuration of general device parameters	.CFG
Configuration for the hardcopy output	.HCS
User-defined color setting	.COL
All defined limit lines	.LIA
Measured data trace 1 to trace 3 screen A	.TR1 to 3
Measured data trace 1 to trace 3 screen B	.TR4 to 6
Peak list or final measurement results	.FIN
Tracking generator settings (only with Tracking Generator Option B9 or Ext. Generator Control B10)	.TCI
Setting for source calibration (only with Tracking Generator Option B9 or Ext. Generator Control B10)	.TS1 .TS2
Correction data for source calibration (only with Tracking Generator Option B9 or Ext. Generator Control B10)	.TC1 .TC2
All defined transducer sets + transducer factors	TSA .TFA
Activated transducer set	.TS
Activated transducer factors	.TF

The file name includes indication of the path and may also include the drive name. The path name complies with DOS conventions.

**Parameter:** <file\_name> ::= DOS file name without extension, extensions see table

**Example:** "MMEM:LOAD:STAT 1, 'A:TEST' "

**Characteristics:** \*RST value: -  
SCPI: conforming

**Mode:** all

This command is an event and is therefore not assigned an \*RST value and has no query.



**MMEMory:LOAD:AUTO** 1,<file\_name>

This command defines which device setting is automatically loaded after the device is switched on. The contents of the file are read after switching on the device and used to define the new device state. The file name includes indication of the path and may also include the drive. The path name complies with DOS conventions.

**Note:** *The data set defined as auto recall set will also be restored by a \*RST-command.*

**Parameter:** <file\_name> ::= DOS file name without extension;  
FACTORY denotes the data set previously in the instrument

**Example:** "MMEM:LOAD:AUTO 1, 'D:\USER\DATA\TEST' "

**Characteristics:** \*RST value: FACTORY  
SCPI: device-specific

**Mode:** all

This command is an event and is therefore not assigned an \*RST value and has no query.

**MMEMory:MDIRectory** <directory\_name>

This command creates a new directory. The file name includes indication of the path and may also include the drive name. The path name complies with DOS conventions.

**Parameter:** <directory\_name> ::= DOS path name

**Example:** "MMEM:MDIR 'D:\USER\DATA' "

**Characteristics:** \*RST value: -  
SCPI: device-specific

**Mode:** all

This command is an event and is therefore not assigned an \*RST value and has no query.

**MMEMory:MOVE** <file\_source>,<file\_destination>

This command renames existing files, if <file\_destination> contains no path indication. Otherwise the file is moved to the indicated path and stored under the file name specified there, if any.

The file name includes indication of the path and may also include the drive. The path name complies with DOS conventions.

**Parameter:** <file\_source>,<file\_destination> ::= <file\_name>  
<file\_name> ::= DOS file name

**Example:**

```
"MMEM:MOVE 'D:\TEST01.CFG' , 'SETUP.CFG' "
```

' Renames TEST01.CFG in SETUP.CFG  
'in directory D:\.

```
"MMEM:MOVE 'D:\TEST01.CFG' , 'D:\USER\DATA' "
```

' Moves TEST01.CFG from D:\ to  
'D:\USER\DATA.

```
"MMEM:MOVE 'D:\TEST01.CFG' , 'D:\USER\DATA\SETUP.CFG' "
```

' Moves TEST01.CFG from D:\ to  
'D:\USER\DATA and renames the file in  
'SETUP.CFG.

**Characteristics:** \*RST value: -  
SCPI: conforming

**Mode:** all

This command is an event and is therefore not assigned an \*RST value and has no query.

**MMEMory:MSIS** <device>

This command changes to the drive indicated. The drive may be the internal hard disk D: or the floppy-disk drive A:.

**Example:** "MMEM:MSIS 'A:' "

**Characteristics:** \*RST value: "D:"  
SCPI: conforming

**Mode:** all

**MMEMory:NAME** <file\_name>

This command defines a destination file for the printout started with the command `HCOPY:IMMEDIATE`. In this case the printer output must be routed to destination *FILE* using the command `"HCOP:DEST 'MMEM' "`.

The file name includes indication of the path and may also include the drive name. The file name and path information comply with DOS conventions.

**Parameter:** <file\_name> ::= DOS filename

**Example:**

```
"HCOP:DEV:LANG BMP"           Selection of data format.
```

```
"HCOP:DEST 'MMEM' "
```

Selection of the output device

```
"MMEM:NAME 'PRINT1.BMP' "
```

Selection of file name.

```
"HCOP:IMM"
```

Start of the printout.

**Characteristics:** \*RST value: -  
SCPI: conforming

**Mode:** all

This command is an event and is therefore not assigned an \*RST value and has no query.

**MMEMory:RDIRectory** <directory\_name>

This command deletes the indicated directory. The directory name includes indication of the path and may also include the drive name. The path name complies with DOS conventions.

**Parameter:** <directory\_name>:= DOS path name

**Example:** "MMEM:RDIR 'D:\TEST' "

**Characteristics:** \*RST value: -  
SCPI: device-specific

**Mode:** all

This command is an event and is therefore not assigned an \*RST value and has no query.

**MMEMory:STORE<1|2>:STATE** 1,<file\_name>

This command stores the current device settings in a series of files which have the indicated file name, but different extensions. The file name includes indication of the path and may also include the drive name. The path name complies with DOS conventions. The numeric suffix in STORE<1|2> is irrelevant with this command.

A list of the extensions used is contained under MMEMory:LOAD:STATE.

**Parameter:** <file\_name> := DOS file name without extension

**Example:** "MMEM:STOR:STAT 1, 'TEST' "

**Characteristics:** \*RST value: -  
SCPI: conforming

**Mode:** all

This command is an event and is therefore not assigned an \*RST value and has no query.

**MMEMory:STORE<1|2>:TRACe** 1 to 3,<file\_name>

This command stores the selected trace (1 to 3) in the measurement window indicated by STORE<1|2> (screen A or B) in a file with ASCII format. The file format is described in chapter 4 in the TRACE menu under the *ASCII-FILE EXPORT* softkey.

The decimal separator (decimal point or comma) for floating-point numerals contained in the file is defined with the command FORMat:DEXPort:DSEPARATOR.

The file name includes indication of the path and the drive name. Indication of the path complies with DOS conventions.

**Parameter:** 1 to 3 := selected measurement curve Trace 1 to 3  
<file\_name> := DOS file name

**Example:** "MMEM:STOR2:TRAC 3, 'A:\TEST.ASC' "  
' Stores trace 3 from screen B in the file 'TEST.ASC on a disk.

**Characteristics:** \*RST value: -  
SCPI: device-specific

**Mode:** all

This command is an event and is therefore not assigned an \*RST value and has no query.

**MMEMory:STORE:FINal** <file\_name>

This command stores the final measurement data in an ASCII file.

The file name includes indication of the path and may also include the drive. The path name corresponds to the DOS conventions.

**Parameter:** <file\_name> := DOS file name

**Example:** "MMEM:STOR:FIN 'A:\TEST.ASC' "

**Characteristics:** \*RST value: -  
SCPI: device-specific

**Mode:** R

This command is an event which is why it is not assigned an \*RST value and has no query.

**MMEMory:CLEar:STATe** 1,<file\_name>

This command deletes the instrument setting selected by <file\_name>. All associated files on the mass memory storage are cleared. A list of the extensions used is included under MMEMory:LOAD:STATe.

The file name includes indication of the path and may also include the drive. The path name complies with DOS conventions.

**Parameter:** <file\_name> ::= DOS file name without extension

**Example:** "MMEM:CLE:STAT 1, 'TEST' "

**Characteristics:** \*RST value: -  
SCPI: device-specific

**Mode:** all

This command is an event and is therefore not assigned an \*RST value and has no query.

**MMEMory:CLEar:ALL**

This command deletes all device settings in the current directory. The current directory can be selected with MMEM:CDIR. The default directory is D:.

**Example:** "MMEM:CLE:ALL "

**Characteristics:** \*RST value: -  
SCPI: device-specific

**Mode:** all

This command is an event and is therefore not assigned an \*RST value and has no query.

**MMEMory:SElect[:ITEM]:HWSettings** ON | OFF

This command includes the hardware settings in the list of data subsets of a device setting to be stored/loaded. The hardware settings include:

- current configuration of general device parameters (general setup)
- current setting of the measurement hardware including markers
- activated limit lines:  
A data set may include 8 limit lines at maximum in each measurement window. This number includes the activated limit lines and, if available, the de-activated limit lines last used. Therefore the combination of the non-activated restored limit lines depends on the sequence of use with the command `MMEM:LOAD`.
- user-defined color setting
- configuration for the hardcopy output
- the activated transducers:  
A data set may include 4 transducer factors at maximum. It comprises the activated factors and, if available, the de-activated factors last used. Therefore the combination of non-activated restored transducer factors depends on the sequence of use with the command `MMEM:LOAD`.
- Tracking generator settings  
(only in conjunction with option Tracking Generator B9 or External Generator Control B10)
- Correction data for source calibration  
(only in conjunction with option Tracking Generator B9 or External Generator Control B10)

**Example:** `"MMEM:SEL:HWS ON"`

**Characteristics:** \*RST value: ON  
SCPI: device-specific

**Mode:** all

**MMEMory:SElect[:ITEM]:TRACe[:ACTive]** ON | OFF

This command adds the active traces to the list of data subsets of a save/recall device setting. Active traces are all traces whose state is not blank.

**Example:** `"MMEM:SEL:TRAC ON"`

**Characteristics:** \*RST value: OFF, ie no traces will be stored  
SCPI: device-specific

**Mode:** all

**MMEMory:SElect[:ITEM]:LINES:ALL** ON | OFF

This command adds all limit lines (activated and de-activated) to the list of device settings to be stored/loaded.

**Example:** `"MMEM:SEL:LIN:ALL ON"`

**Characteristics:** \*RST value: ON  
SCPI: device-specific

**Mode:** all

**MMEMory:SElect[:ITEM]:FINal** ON | OFF

This command includes the final measurement data in the list of partial datasets of a device setting to be stored/loaded.

**Example:** "MMEM:SEL:FIN ON" 'inserts the final measurement data in the list of partial 'data sets

**Features:** \*RST value: ON  
SCPI: device-specific

**Modes:** all

This command is only available from firmware 1.40 on.

**MMEMory:SElect[:ITEM]:SCData** ON | OFF

This command adds the tracking generator calibration data to the list of device settings to be stored/loaded.

**Example:** "MMEM:SEL:SCD ON" 'Inserts the tracking generator correction data 'in the list of data subsets

**Characteristics:** \*RST value: OFF  
SCPI: device-specific

**Modes:** all

This command is only available in conjunction with the tracking generator option B9 or external generator control option B10.

**MMEMory:SElect[:ITEM]:TRANSducer[:ACTive]** ON | OFF

This command includes the active transducer factors and set in the list of data subsets of a device setting to be stored/loaded.

**Example:** "MMEM:SEL:TRAN ON"

**Characteristics:** \*RST value: ON  
SCPI: device-specific

**Modes:** all

Upon MMEM:LOAD the transducer factors and sets which are not currently active but contained in the data set are restored as well.

**MMEMory:SElect[:ITEM]:TRANSducer:ALL** ON | OFF

This command includes all transducer factors and sets in the list of data subsets of a device setting to be stored/loaded.

**Example:** "MMEM:SEL:TRAN:ALL ON"

**Characteristics:** \*RST value: ON  
SCPI: device-specific

**Modes:** all

This command is an event and therefore has no \*RST value assigned.

**MMEMory:SElect[:ITEM]:ALL**

This command includes all data subsets in the list device settings to be stored/loaded.

**Example:** "MMEM:SEL:ALL"

**Characteristics:** \*RST value: --  
SCPI: device-specific

**Mode:** all

This command is an event and therefore has no \*RST value assigned.

**MMEMory:SElect[:ITEM]:NONE**

This command deletes all data subsets from the list of device settings to be stored/loaded.

**Example:** "MMEM:SEL:NONE"

**Characteristics:** \*RST value: --  
SCPI: device-specific

**Mode:** all

This command is an event and therefore has no \*RST value assigned.

**MMEMory:SElect[:ITEM]:DEFault**

This command sets the default list of device settings to be stored/loaded. The latter includes:

- current configuration of general device parameters (general setup)
- current setting of the measurement hardware including markers
- activated limit lines
- user-defined color setting
- configuration for the hardcopy output
- tracking generator settings  
(only in conjunction with option Tracking Generator B9 or External Generator Control B10)
- correction data for source calibration  
(only in conjunction with option Tracking Generator B9 or External Generator Control B10)
- activated transducers

Trace data, non-used transducer factors/sets and non-used limit lines are not included.

**Example:** "MMEM:SEL:DEFault"

**Characteristics:** \*RST value: --  
SCPI: device-specific

**Mode:** all

This command is an event and therefore has no \*RST value assigned.

**MMEMory:COMMeNT <string>**

This command defines a comment ( max. 60 characters) for a device setting to be stored.

**Example:** "MMEM:COMM 'Setup for GSM measurement'"

**Characteristics:** \*RST value: blank comment  
SCPI: device-specific

**Mode:** all

## OUTPut Subsystem

The OUTPut subsystem controls the output features of the instrument.

In conjunction with the tracking generator option, a distinction is made between OUTPut1 (screen A) and OUTPut2 (screen B).

COMMAND	PARAMETERS	UNIT	COMMENT
OUTPut<1 2> [:STATe] :UPORt [:VALue] :STATe	<boolean>  <binary> <boolean>	--  -- --	Tracking generator option

### OUTPut<1|2>[:STATe] ON | OFF

This command switches the tracking generator on or off.

**Notes:** - With the tracking generator switched on, the maximum stop frequency is limited to 3 GHz. This upper limit is automatically modified by the set frequency offset of the generator.

- If measurements in compliance with specs are to be performed with the tracking generator, the start frequency has to be  $\geq 3 \times$  resolution bandwidth.

- The minimum sweep time for measurements in compliance with the data sheet is 100 ms in the frequency domain (span >0). If a shorter sweep time is selected, the sweep time indicator SWT on the screen is marked with a red asterisk and the message UNCAL is also displayed.

- With the tracking generator switched on, the FFT filters (BAND:MODE:FFT) are not available.

**Example:** "OUTP ON" 'Switches on the tracking generator in screen A.

**Characteristics:** \*RST value: -  
SCPI: conforming

**Modes:** A

This command is only valid in conjunction with option tracking generator.

### OUTPut:UPORt[:VALue] #B00000000 to #B11111111

This command sets the control lines of the user ports. In manual operation, the control lines are represented by softkeys PORT 0 to 7.

The user port is written to with the given binary pattern. If the user port is programmed to INPut instead of OUTPut, the output value is temporarily stored.

**Example:** "OUTP:UPOR #B10100101"

**Characteristics:** \*RST value: -  
SCPI: device-specific

**Modes:** all

### OUTPut:UPORt:STATe ON | OFF

This command switches the control line of the user ports between INPut and OUTPut.

The user port is switched to OUTPut with parameter ON, to INPut with OFF.

**Example:** "OUTP:UPOR:STAT ON"

**Characteristics:** \*RST value: OFF  
SCPI: device-specific

**Modes:** all



## SENSe Subsystem

The SENSe subsystem is organized in several subsystems. The commands of these subsystems directly control device-specific settings, they do not refer to the signal characteristics of the measurement signal.

The SENSe subsystem controls the essential parameters of the receiver. In accordance with the SCPI standard, the keyword "SENSe" is optional for this reason, which means that it is not necessary to include the SENSe node in command sequences.

The measurement windows are selected by SENSe1 and SENSe2:

SENSe1 = Modification of screen A settings

SENSe2 = Modification of screen B settings.

Screen A is automatically selected if 1 or 2 is missing.

## SENSe:AVERage Subsystem

The SENSe:AVERage subsystem calculates the average of the acquired data. A new test result is obtained from several successive measurements.

There are two types of average calculation: logarithmic and linear. In case of logarithmic average calculation (denoted with VIDEo), the average value of the measured logarithmic power is calculated and in case of linear average calculation, the linear power is averaged before the logarithm is applied.

The measurement windows are selected by SENSe1 (screen A) and SENSe2 (screen B).

COMMAND	PARAMETERS	UNIT	COMMENT
[SENSe<1 2>] :AVERage			
:COUNT	<numeric_value>	--	
[:STATe<1 to 3>]	<Boolean>	--	
:TYPE	VIDeo   LINear	--	

### [SENSe<1|2>]:AVERage:COUNT 0 to 32767

In receiver mode, this command defines the number of scan started with single scan (no average calculation possible). In analyzer mode, it defines the number of measurements which contribute to the average value.

It should be noted that continuous averaging will be performed after the indicated number has been reached in continuous sweep mode.

In single sweep or scan mode, the scan/sweep is stopped as soon as the indicated number of measurements (scans/sweeps) is reached. Synchronization to the end of the indicated number of measurements is only possible in single scan/sweep mode.

The command [SENSe<1 | 2>]:AVERage:COUNT is the same as command [SENSe<1 | 2>]:SWEep:COUNT. In both cases, the number of measurements is defined whether the average calculation is active or not.

The number of measurements is valid for all traces in the indicated measurement window.

**Example:**

"SWE:CONT OFF"	Switching to single-sweep mode.
"AVER:COUN 16"	'Sets the number of measurements to 16.
"AVER:STAT ON"	'Switches on the calculation of average.
"INIT;*WAI"	'Starts the measurement and waits for the end of the 16 sweeps.

**Characteristics:** \*RST value: 0  
SCPI: conforming

**Mode:** all

**[SENSe<1|2>:]AVERage[:STATe<1 to 3>] ON | OFF**

This command switches on or off the average calculation for the selected trace (STATe<1 to 3>) in the selected measurement window.

**Example:** "AVER OFF" 'Switches off the average calculation for trace 1 in screen A.  
 "SENS2:AVER:STAT3 ON" 'Switches on the average calculation for trace 3 in screen B.

**Characteristics:** \*RST value: OFF  
 SCPI: conforming

**Mode:** all

**[SENSe<1|2>:]AVERage:TYPE VIDEo | LINear**

This command selects the type of average function. If VIDEo is selected, the logarithmic power is averaged and, if LINear is selected, the power values are averaged before they are converted to logarithmic values.

The type of average calculation is equally set for all traces in one measurement window.

**Example:** "AVER:TYPE LIN" 'Switches screen A to linear average calculation.

**Characteristics:** \*RST value: VIDEo  
 SCPI: device-specific

**Mode:** A

## SENSe:BANDwidth Subsystem

This subsystem controls the setting of the instrument's filter bandwidths. Both groups of commands (BANDwidth and BWIDth) perform the same functions. The measurement windows are selected by SENSe1 (screen A) and SENSe2 (screen B).

COMMAND	PARAMETERS	UNIT	COMMENT
[SENSe<1 2>] :BANDwidth			
[:RESolution]	<numeric_value>	HZ	
:AUTO	<Boolean>	--	
:RATio	<numeric_value>	--	
:TYPE	NORMal   FFT   CFILter   RRC	--	
:TYPE	NORMal   FFT   CFILter   RRC   NOISe   PULSe	--	
:VIDeo	<numeric_value>	HZ	
:AUTO	<Boolean>	--	
:RATio	<numeric_value>	--	
:TYPE	LINear   LOGarithmic		
:BWIDth			
[:RESolution]	<numeric_value>	HZ	
:AUTO	<Boolean>	--	
:RATio	<numeric_value>	--	
:TYPE	NORMal   FFT   CFILter   RRC   NOISe   PULSe	--	
:VIDeo	<numeric_value>	HZ	
:AUTO	<Boolean>	--	
:RATio	<numeric_value>	--	
:TYPE	LINear   LOGarithmic		

**[SENSe<1|2>:]BANDwidth|BWIDth[:RESolution]** <numeric\_value>

This command defines the receiver IF bandwidth or, in *SPECTRUM* mode, the analyzer's resolution bandwidth.

Analog resolution filters from 10 Hz to 10 MHz in 1, 3, 10 steps are available. These filters are analog characteristic in the range of 10 Hz to 100 kHz.

In addition, the EMI bandwidths 200 Hz, 9 kHz and 120 kHz are available (6 dB bandwidths each).

The EMI bandwidths are only available when parameter *PULSe* is selected by command *BAND:TYPE*.

FFT filters from 1 Hz to 30 kHz (3 dB bandwidth each) are also available in the frequency domain (span > 0) for fast measurements on periodic signals. The instrument automatically switches to analog filters above 30 kHz.

The FFT-bandwidths are not available if the preselector is switched on or in *RECEIVER* mode.

A number of especially steep-edged channel filters can be selected provided that parameters *CFILter* or *RRC* are selected using the *BAND:TYPE* command. The possible combinations of filter type and filter bandwidth are listed in the table "List of available channel filters" of chapter 4, section "Setting Bandwidths and Sweep Time— Key *BW*".

If the resolution bandwidth is modified in *SPECTRUM* mode, the coupling to the span is automatically switched off.

**Example:** "BAND 120 kHz" 'Sets the IF bandwidth to 120 kHz

**Characteristics:** \*RST value: - (AUTO is set to ON)  
SCPI: conforming

**Mode:** all

**[SENSe<1|2>:]BANDwidth|BWIDTH[:RESolution]:AUTO ON | OFF**

In RECEIVER mode with activated quasi peak detector, this command either automatically couples the IF bandwidth of the receiver to the frequency range or cancels the coupling .

In SPECTRUM mode, this command either automatically couples the resolution bandwidth of the instrument to the span or cancels the coupling.

The automatic coupling adapts the resolution bandwidth to the currently set frequency span according to the relationship between frequency span and resolution bandwidth. The 6 dB bandwidths 200 Hz, 9 kHz and 120 kHz and the channel filters are not set by the automatic coupling.

The ratio resolution bandwidth/span can be modified with the command  
[SENSe<1|2>:]BANDwidth[:RESolution]:RATio.

**Example:** "BAND:AUTO OFF" 'Switches off the coupling of the IF bandwidth to the frequency range (receiver mode).  
'Switches off the coupling of the resolution bandwidth to the span (analyzer mode).

**Characteristics:** \*RST value: ON  
SCPI: conforming

**Mode:** R, A-F

**[SENSe<1|2>:]BANDwidth|BWIDTH[:RESolution]:RATio 0.0001 to 1**

This command defines the ratio resolution bandwidth (Hz) / span (Hz). The ratio to be entered is reciprocal to the ratio span/RBW used in manual control.

**Example:** "BAND:RAT 0.1"

**Characteristics:** \*RST value: 0.02 with BAND:TYPE NORMal or RBW > 30 kHz  
0.01 with BAND:TYPE FFT for RBW ≤ 30 kHz  
SCPI: conforming

**Mode:** A

**[SENSe<1|2>:]BANDwidth|BWIDTH[:RESolution]:TYPE NORMal| FFT |CFILter |RRC |NOISe | PULSe**

This command switches the filter type for the resolution bandwidth between "normal" analog or FIR filters in 1, 3, 10 steps and the FFT filtering for bandwidths <100 kHz.

The advantage of FFT filtering is the higher measurement speed compared to digital filters with analog filter characteristic. However, FFT filters are only suitable for periodic signals, and they are only available for span > 0 Hz.

Steep-edged channel filters and filters with RRC (Root Raised Cosine) characteristic are available. The possible combinations of filter type and filter bandwidth are listed in the table "List of available channel filters" in chapter 4, section "Setting Bandwidths and Sweep Time– Key BW".

The filter type PULSe selects the 6 dB bandwidths for EMI measurements rather than the 3 dB bandwidths for spectrum analysis, which is selected with type NOISe.

**Notes:** - When changing the filter type, the next larger filter bandwidth is selected if the same filter bandwidth is not available for the new filter type.

**Example:** "BAND:TYPE NORM"

**Characteristics:** \*RST value: NORMal  
SCPI: device-specific

**Mode:** all

**[SENSe<1|2>:]BANDwidth|BWIDth:VIDeo** 1Hz to 10MHz

This command defines the instrument's video bandwidth. Bandwidths from 10 Hz to 10 MHz in 1, 3, 10 steps are available. The command is not available if FFT filtering is switched on and the set bandwidth is  $\leq 30$  kHz or if the quasi-peak detector is switched on.

**Example:** "BAND:VID 10kHz"

**Characteristics:** \*RST value: - (AUTO is set to ON)  
SCPI: conforming

**Mode:** A

**[SENSe<1|2>:]BANDwidth|BWIDth:VIDeo:AUTO** ON | OFF

This command either automatically couples the instrument's video bandwidth to the resolution bandwidth or cancels the coupling.

The ratio video bandwidth/resolution bandwidth can be modified with the command  
[SENSe<1|2>:]BANDwidth:VIDeo:RATio.

**Note:** *In receiver mode, the video bandwidth is set to ten times the resolution bandwidth.*

**Example:** "BAND:VID:AUTO OFF"

**Characteristics:** \*RST value: ON  
SCPI: conforming

**Mode:** A

**[SENSe<1|2>:]BANDwidth|BWIDth:VIDeo:TYPE** LINear | LOGarithmic

This command selects the configuration of the videofilters in the signal path if the resolution bandwidth is  $\leq 100$  kHz:

LINear The video filter is connected ahead of the log module (default)

LOGarithmic The video filter is connected behind the log module

The main difference between the two modes is the transient response at the falling signal edge. In LINear mode the falling edge is measured "flatter" than in LOGarithmic mode. This results from the conversion of linear power in logarithmic level. A division in half of the linear power corresponds to a level decrease of only 3 dB.

**Example:** "BAND:VID:TYPE LIN" 'selects the video filter connection ahead of the log module

**Characteristics:** \*RST value: LIN  
SCPI: conforming

**Mode:** A,

**[SENSe<1|2>:]BANDwidth|BWIDth:VIDeo:RATio** 0.01 to 1000

This command defines the ratio video bandwidth (Hz) / resolution bandwidth (Hz). The ratio to be entered is reciprocal to the ratio RBW/VBW used in manual control.

**Example:** "BAND:VID:RAT 3" 'Sets the coupling of video bandwidth to video  
'bandwidth = 3\*resolution bandwidth

**Characteristics:** \*RST value: 3  
SCPI: conforming

**Mode:** A

## SENSe:CORRection Subsystem

The SENSe:CORRection subsystem controls the correction of measured results by means of frequency-dependent correction factors (e. g. for antenna or cable attenuation). This subsystem also controls calibration and normalization during operation with the tracking generator options (B9/B10). The measurement windows are selected by SENSe1 (screen A) and SENSe2 (screen B).

COMMAND	PARAMETERS	UNIT	COMMENT
[SENSe<1 2>] :CORRection			Tracking Generator option
:METHod	TRANsmission   REFLexion		
:COLLect			
[:ACQUIRE]	THROUGH   OPEN		no query
[:STATe]	<Boolean>		
:RECall			no query
:TRANsducer			
:SELect	<name>		
:UNIT	<string>		
:SCALing	LINear LOGarithmic		
:DATA	<freq> , <level> ..	HZ , --	
[:STATe]	<Boolean>		
:DELete	--	--	No query
:TSET			
:SELect	<name>		
:UNIT	<string>		
:BReak	<Boolean>		
:RANGe<1 to 10>	<freq> , <freq> , @<name> ..	HZ, HZ, --	
[:STATe]	<Boolean>		
:DELete	--	--	No query

### [SENSe<1|2>:]CORRection[:STATe] ON | OFF

This command activates/deactivates the normalization of the measurement results in the selected window provided that the tracking generator is active. The command is available only after acquisition of a reference trace for the selected type of measurement (transmission/reflection, see command [SENSe<1|2>:]CORRection:COLLect[:ACQUIRE]).

**Example:** "CORR ON " 'Activates normalization in screen A.

**Characteristics:** \*RST value: OFF  
SCPI: conforming

**Mode:** A

This command is only valid in conjunction with the tracking generator / ext. generator control option (B9/B10).

**[SENSe<1|2>:]CORRection:METHod** TRANsmission | REFLeXion

This command selects the type of measurement with active tracking generator (transmission/reflexion).

**Example:**           " CORR : METH TRAN " 'Sets the type of measurement in screen A to "transmission".

**Characteristics:** \*RST value:   TRANsmission  
SCPI:                device specific

**Mode:**             A

This command is only valid in conjunction with the tracking generator / ext. generator control option (B9/B10).

**[SENSe<1|2>:]CORRection:COLLect[:ACQuire]** THRough | OPEN

This command selects the kind of measurement for the reference values of the normalization (response calibration).

THRough           "TRANsmission" mode:   calibration with direct connection between tracking generator and device input.

                  "REFLeXion" mode:       calibration with short circuit at the input

OPEN              only valid in "REFLeXion" mode:  calibration with open input

This command is an event and is therefore not assigned an \*RST value and has no query.

This command is only valid in conjunction with the tracking generator / ext. generator control option (B9/B10).

**Example:**           " CORR : COLL THR "               'Selects single sweep operation  
                  " CORR : COLL THR ; \*WAI "   'Starts the measurement of reference data using 'direct connection between generator and device 'input and waits for the sweep end.

**Characteristics:** \*RST value:   --  
SCPI:                conforming

**Mode:**             A

**[SENSe<1|2>:]CORRection:RECall**

This command restores the instrument setting that was valid for the measurement of the reference data, provided that the tracking generator is active.

**Example:**           " CORR : REC "

**Characteristics:** \*RST value:   -  
SCPI:                conforming

**Mode:**             A

This command is an event and is therefore not assigned an \*RST value and has no query.

This command is only valid in conjunction with the tracking generator / ext. generator control option (B9/B10).

**[SENSe<1|2>:]CORRection:TRANsducer:SELEct <name>**

This command selects the transducer factor designated by <name>. If <name> does not exist yet, a new transducer factor is created.

**Parameter:** <name>::= Name of the transducer factor in string data form with a maximum of 8 characters.

**Example:** "CORR:TRAN:SEL 'FACTOR1' "

**Characteristics:** \*RST value: -  
SCPI: device-specific

**Modes:** R, A

This command must be sent prior to the subsequent commands for modifying/activating transducer factors.

**[SENSe<1|2>:]CORRection:TRANsducer:UNIT <string>**

This command defines the unit of the transducer factor selected.

**Parameter:** <string>::= 'DB' | 'DBM' | 'DBMV' | 'DBUV' | 'DBUV/M' | 'DBUA' | 'DBUA/M' | 'DBPW' | 'DBPT'

**Example:** "CORR:TRAN:UNIT 'DBUV' "

**Characteristics:** \*RST value: 'DB'  
SCPI: device-specific

**Modes:** R, A

Prior to this command, the command SENS:CORR:TRAN:SEL must be sent.

**[SENSe<1|2>:]CORRection:TRANsducer:SCALing LINear | LOGarithmic**

This command defines whether the frequency scaling of the transducer factor is linear or logarithmic.

**Example:** "CORR:TRAN:SCAL LOG"

**Characteristics:** \*RST value: LINear  
SCPI: device-specific

**Modes:** R, A

Prior to this command, the command SENS:CORR:TRAN:SEL must be sent.

**[SENSe<1|2>:]CORRection:TRANsducer:DATA <freq>,<level>..**

This command defines the test points for the selected transducer factor. The values are entered as a series of frequency/level pairs. The frequencies must be in ascending order.

**Example:** "CORR:TRAN:TRANsducer:DATA 1MHZ,-30,2MHZ,-40"

**Characteristics:** \*RST value: -  
SCPI: device-specific

**Modes:** R, A

Prior to this command, the command SENS:CORR:TRAN:SEL must be sent. The level values are sent as dimensionless numbers; the unit is specified by means of the command SENS:CORR:TRAN:UNIT.



**[SENSe<1|2>:]CORRection:TRANsducer[:STATe] ON | OFF**

This command switches the selected transducer factor on or off.

**Example:** "CORR:TRAN ON"

**Characteristics:** \*RST value: OFF  
SCPI: device-specific

**Modes:** R, A

Prior to this command, the command SENS:CORR:TRAN:SEL must be sent.

**[SENSe<1|2>:]CORRection:TRANsducer:DELeTe**

This command deletes the selected transducer factor.

**Example:** "CORR:TRAN:DEL"

**Characteristics:** \*RST value: -  
SCPI: device-specific

**Modes:** R, A

This command is an event and therefore has no \*RST value.

Prior to this command, the command SENS:CORR:TRAN:SEL must be sent.

**[SENSe<1|2>:]CORRection:TSET:SELeCt <name>**

This command selected the transducer set designated by <name>. If <name> does not exist yet, a new set is created.

**Parameter:** <name>::= name of the transducer set in string data form with a maximum of 8 characters.

**Example:** "CORR:TSET:SEL 'SET1'"

**Characteristics:** \*RST value: -  
SCPI: device-specific

**Modes:** R, A

This command must be sent prior to the subsequent commands for changing/activating the transducer sets.

**[SENSe<1|2>:]CORRection:TSET:UNIT '<string>**

This command defines the unit of the selected transducer sets. When assigning transducer factors to the set, only factors which are compatible to the selected unit, i. e. factors with the same unit or the unit dB, are allowed.

**Parameter:** <string>::= DB' | 'DBM' | 'DBUV' | 'DBUV/M' | 'DBUA' | 'DBUA/M' | 'DBPW' | 'DBPT'

**Example:** "CORR:TSET:UNIT 'DBUV'"

**Characteristics:** \*RST value: 'DB'  
SCPI: device-specific

**Modes:** R, A

Prior to this command, the command SENS:CORR:TSET:SEL must be sent.

**[SENSe<1|2>:]CORRection:TSET:BR EAk ON | OFF**

This command defines if the sweep is to be stopped on changeover from range to another.

**Example:** "CORR:TSET:BR EAk ON"

**Characteristics:** \*RST value: OFF  
SCPI: device-specific

**Modes:** R, A

Prior to the above command, the command SENS:CORR:TSET:SEL must be sent.

**[SENSe<1|2>:]CORRection:TSET:RANGe<1 to 10> <freq>,<freq>,<name>..**

This command defines a partial range of the selected transducer set. The partial range is determined by its start and stop frequencies plus a list of names of the assigned transducer factors. The ranges 1 to 10 must be sent in ascending order.

**Parameter:** <freq>,<freq>::= start frequency, stop frequency of the range  
<name>...::= list of names for the assigned transducer factors.  
The individual names must be characterized by single quotation marks (') and separated by commas.

**Example:** "CORR:TRAN:TSET:RANG 1MHZ,2MHZ,'FACTOR1','FACTOR2'"

**Characteristics:** \*RST value: -  
SCPI: device-specific

**Modes:** R, A

Prior to this command, the command SENS:CORR:TSET:SEL must be sent.

**[SENSe<1|2>:]CORRection:TSET[:STATe] ON | OFF**

This command switches the selected transducer set on or off.

**Example:** "CORR:TSET ON"

**Characteristics:** \*RST value: OFF  
SCPI: device-specific

**Modes:** R, A

Prior to this command, the command SENS:CORR:TSET:SEL must be sent.

**[SENSe<1|2>:]CORRection:TSET:DELete**

This command deletes the selected transducer set.

**Example:** "CORR:TSET:DEL"

**Characteristics:** \*RST value: -  
SCPI: device-specific

**Modes:** R, A

This command is an event and therefore has no \*RST value.

Prior to this command, the command SENS:CORR:TSET:SEL must be sent.

## SENSe:DEMod Subsystem

The SENSe:DEMod subsystem controls the analog demodulation of the video signal.

COMMAND	PARAMETER	UNIT	COMMENT
[SENSe<1 2>] :DEMod	OFF   AM   FM		

**[SENSe<1|2>:]DEMod** OFF | AM | FM

This command selects the type of analog demodulation.

**Example:** "DEM FM"

**Characteristics:** \*RST value: OFF  
SCPI: device-specific

**Modes:** R, A

## SENSe:DETECTOR Subsystem

The SENSe:DETECTOR subsystem controls the acquisition of measurement data via the selection of the detector for the corresponding trace. The measurement windows are selected by SENSe1 (screen A) and SENSe2 (screen B).

COMMAND	PARAMETERS	UNIT	COMMENT
[SENSe<1 2>] :DETECTOR<1 to 3> [:FUNCTION]  :AUTO :RECEIVER [:FUNCTION]  :FMEASUREMENT	APEAK   POSITIVE   SAMPLE   RMS   AVERAGE   QPEAK  <Boolean>  POSITIVE   NEGATIVE   RMS   AVERAGE   QPEAK, POSITIVE   NEGATIVE   RMS   AVERAGE   QPEAK POSITIVE NEGATIVE  RMS  AVERAGE QPEAK		

[SENSe<1|2>:]DETECTOR<1..3>[:FUNCTION] APEAK | NEGATIVE | POSITIVE | SAMPLE | RMS |  
AVERAGE | QPEAK

This command switches on the detector for the data acquisition in the selected trace and the indicated measurement window.

- The APEAK detector (AutoPeak) displays the positive and also the negative peak value of the noise floor. If a signal is detected, only the positive peak value is displayed.
- The POSITIVE or NEGATIVE detector only displays the positive or the negative peak value.
- With the Sample detector the value measured at the sampling time is displayed, whereas the RMS value of the power measured at each test point is displayed with the RMS detector.
- The AVERAGE detector displays the power average value at each test point.
- The QPEAK detector performs a signal evaluation for EMC measurements.

If QPEAK is selected, the video filter is automatically switched off. The couplings between span and RBW as well as between RBW and sweep time are also switched off and restored on selecting another detector. A long sweep time should be selected so that the quasi-peak detector can fully settle at each test point.

The trace is indicated as numeric suffix in DETECTOR.

**Example:** "DET POS" 'Sets the detector in screen A to "positive peak".

**Characteristics:** \*RST value: APEAK  
SCPI: conforming

**Mode:** A

[SENSe<1|2>:]DETECTOR<1 to 3>[:FUNCTION]:AUTO ON | OFF

This command either couples the detector in the selected measurement window to the current trace setting or turns coupling off. The trace is selected by the numeric suffix at DETECTOR.

**Example:** "DET:AUTO OFF"

**Characteristics:** \*RST value: ON  
SCPI: conforming

**Mode:** A

**[SENSe<1|2>:]DETECTOR:RECEIVER[:FUNCTION]** POSitive | NEGative | RMS | AVERAge | QPEak

This command activates the detectors for single point measurements in EMI receiver operating mode.

A trace cannot be selected. Three detectors can be activated at the same time.

**Example:** "DET:REC POS,AVER,QPE" activates the detectors Peak, Average and Quasipeak.

**Characteristics:** \*RST value: POS  
SCPI: conforming

**Mode:** R

**[SENSe<1|2>:]DETECTOR<1 to 3>:FMEASUREMENT** NEGative | POSitive | RMS | AVERAge | QPEak

This command selects the detector for the final measurement (the detector used subsequent to the prescan)

**Example:** "DET:FME POS"

**Characteristics:** \*RST value: Trace 1 QPEak  
Trace 2 AVERAge  
Trace 3 RMS  
SCPI: device-specific

**Mode:** R

## SENSe:FREQuency Subsystem

The SENSe:FREQuency subsystem defines the frequency-axis of the active display. The frequency-axis can either be defined via the start/stop frequency or via the center frequency and span. The measurement windows are selected by SENSe1 (screen A) and SENSe2 (screen B).

COMMAND	PARAMETERS	UNIT	COMMENT
[SENSe<1 2>] :FREQuency			
:CENTer	<numeric_value>	HZ	
:STEP	<numeric_value>	HZ	
:LINK	SPAN RBW OFF	--	
:FACTor	<numeric_value>	PCT	
:SPAN	<numeric_value>	HZ	
:FULL	--	--	
:START	<numeric_value>	HZ	
:STOP	<numeric_value>	HZ	
:MODE	CW FIXed SWEep		
:OFFSet	<numeric_value>	HZ	
:CW	<numeric_value>	HZ	
:STEP	<numeric_value>	HZ	
:FIXed	<numeric_value>	HZ	
:STEP	<numeric_value>	HZ	

### [SENSe<1|2>]:FREQuency:CENTer 0 to $f_{max}$

This command defines the receiver frequency or the center frequency in analyzer mode.

**Example:** "FREQ:CENT 100MHz"

**Characteristics:** \*RST value:  $f_{max}/2$  with  $f_{max}$  = maximum frequency  
SCPI: conforming

**Mode:** all

### [SENSe<1|2>]:FREQuency:CENTer:STEP 0 to $f_{max}$

This command defines the step width of the center frequency.

**Example:** "FREQ:CENT:STEP 120MHz"

**Characteristics:** \*RST value: - (AUTO 0.1  $\times$  SPAN is switched on)  
SCPI: conforming

**Mode:** all

### [SENSe<1|2>]:FREQuency:CENTer:STEP:LINK SPAN | RBW | OFF

This command couples the step width of the center frequency to span (span > 0) or to the resolution bandwidth (span = 0) or cancels the couplings.

**Parameters:**

SPAN = Coupling to frequency display range (for span > 0)  
RBW = Coupling to resolution bandwidth (for span = 0)  
OFF = manual input, no coupling.

**Example:** "FREQ:CENT:STEP:LINK SPAN"

**Characteristics:** \*RST value: SPAN  
SCPI: device-specific

**Mode:** A

**[SENSe<1|2>:]FREQUENCY:CENTer:STEP:LINK:FACTor** 1 to 100 PCT

This command couples the step width of the center frequency with a factor to the span (span >0) or to the resolution bandwidth (span = 0).

**Example:** "FREQ:CENT:STEP:LINK:FACT 20PCT"

**Characteristics:** \*RST value: - (AUTO 0.1 × SPAN is switched on)  
SCPI: device-specific

**Mode:** A

**[SENSe<1|2>:]FREQUENCY:SPAN** 0 to  $f_{max}$ 

This command defines the frequency span in the analyzer mode.

**Example:** "FREQ:SPAN 10MHz"

**Characteristics:** \*RST value:  $f_{max}$  with  $f_{max}$  = maximum frequency  
SCPI: conforming

**Mode:** A

**[SENSe<1|2>:]FREQUENCY:SPAN:FULL**

This command sets the frequency span in the analyzer mode to its maximum.

**Example:** "FREQ:SPAN:FULL"

**Characteristics:** \*RST value: -  
SCPI: conforming

**Mode:** A

**[SENSe<1|2>:]FREQUENCY:START** 0 to  $f_{max}$ 

This command defines the start frequency of the overall scan in receiver mode. It defines the start frequency of the sweep in analyzer mode..

**Example:** "FREQ:STAR 20MHz"

**Characteristics:** \*RST value: 0  
SCPI: conforming

**Mode:** R, A-F

**[SENSe<1|2>:]FREQUENCY:STOP** 0 to  $f_{max}$ 

This command defines the stop frequency of the overall scan in receiver mode. It defines the stop frequency of the sweep in analyzer mode..

**Example:** "FREQ:STOP 2000MHz"

**Characteristics:** \*RST value:  $f_{max}$   
SCPI: conforming

**Mode:** E, A-F

**[SENSe<1|2>:]FREQuency:MODE CW | FIXed | SWEep**

This command switches between frequency domain (SWEep) and time domain (CW | FIXed) in SPEVTRUM mode.

For CW and FIXed, the frequency setting is via command FREQuency:CENTer. In the SWEep mode, the setting is via commands FREQuency:START, STOP, CENTer and SPAN.

**Example:** "FREQ:MODE SWE"  
**Characteristics:** \*RST-Wert: CW  
 SCPI: konform  
**Mode:** R, A

**[SENSe<1|2>:]FREQuency:OFFSet <numeric\_value>**

This command defines the frequency offset of the instrument.

**Example:** "FREQ:OFFS 1GHZ"  
**Characteristics:** \*RST value: 0 Hz  
 SCPI: conforming  
**Mode:** A

**[SENSe<1|2>:]FREQuency[:CW]:FIXed] <numeric\_value>**

This command defines the receiver frequency.

**Example:** "FREQ 300 MHZ"  
**Characteristics:** \*RST value: -  
 SCPI: conforming  
**Mode:** R

**[SENSe<1|2>:]FREQuency[:CW]:FIXed]:STEP <numeric\_value>**

This command defines the step width of the receiver frequency.

**Example:** "FREQ 50 kHz"  
**Characteristics:** \*RST value: -  
 SCPI: conforming  
**Mode:** R



## SENSe:LIST Subsystem

The commands of this subsystem are used for measuring the power at a list of frequency points with different device settings. The measurement is always performed in the time domain (span = 0 Hz).

A new trigger event is required for each test point (exception: Trigger FREE RUN).

The results are output as a list in the order of the entered frequency points. The number of results per test point depends on the number of concurrently active measurements (peak/RMS/average).

Selection of concurrently active measurements and setting of parameters that are constant for the whole measurement is via a configuration command (SENSe:LIST:POWer:SET). This also includes the setting for trigger and gate parameters.

The following setting parameters can be selected independently for each frequency point:

- Analyzer frequency
- Reference level
- RF attenuation
- Resolution filter
- Resolution bandwidth
- Video bandwidth
- Measurement time
- Detector

The number of frequencies is limited to 100 entries.

The commands of this subsystem can be used in two different ways:

1. Instrument setup, measurement and querying of the results in a single command:  
With this method, there is the least delay between the measurement and the result output. However, it requires the control computer to wait for the response from the instrument.
2. Instrument setup and querying of the result list at the end of the measurement:  
With this method, the control computer may be used for other activities while the measurement is being performed. However, more time is needed for synchronization via service request.

**Note:** *Settings that are not directly included in commands of this subsystem can be configured by sending the corresponding commands prior to the SENSe:LIST-commands.*

*Please note that changes to the trigger level have to be executed in time domain (span = 0 Hz) in order to take effect for the SENSe:LIST-commands.*

COMMAND	PARAMETER	UNIT	COMMENT
[SENSe<1 2>] :LIST :POWer :RESult? [:SEQuence]	<numeric_value>, <numeric_value>, <numeric_value>, <numeric_value>   OFF, NORMal   CFILter   RRC, <numeric_value>, <numeric_value>, <numeric_value>, <numeric_value>	HZ, DBM, DB, DB, --, HZ, HZ, S, PCT DBM	Query only
:SET	<Boolean>, <Boolean>, <Boolean>, IMMediate   EXTernal   VIDeo   IFPower, POSitive NEGative, <numeric_value>, <numeric_value>	--, --, --, --, --, S, S	
:STATe	OFF		

**[SENSe<1|2>]:LIST:POWer[:SEQuence]** <analyzer freq>,<ref level>,<rf att>,OFF,  
<filter type>,<rbw>,<vbw>,<meas time>,<trigger level>,...

This command configures the list of settings (max. 100 entries) for the multiple power measurement and starts a measurement sequence. When synchronizing the command with \*OPC, a service request is generated as soon as all frequency points are processed and the defined number of individual measurements (# of meas) is reached.

To reduce the setting time, all indicated parameters are set up simultaneously at each test point.

The query form of the command processes the list and immediately returns the list of results. The number of results per test point depends on the setting of the "SENSe:LIST:POWer:SET" command.

**Parameter: Note:** The following parameters are the settings for an individual frequency point. They are repeated for every other frequency point.  
*For reasons of compatibility to FSP instrument family , input OFF is required after parameter <rf att>.*

- <analyzer freq>: Receive frequency for the signal to be measured  
(= center frequency in manual operation)  
Range of values: 0 Hz to max. frequency, depending on the instrument model.
- <ref level>: Reference level  
Range of values: +30 dBm to -75 dBm in 5 dB steps
- <rf att>: RF input attenuation  
Range of values: 0 dB to 75 dB in 5 dB steps

OFF:	always OFF
<filter type>:	NORMal: normal resolution filter CFILter: channel filter. These are especially steep-edged filters, which are used for example in Fast ACP measurement to ensure the band-limiting of a transmission channel in the time domain. RRC: Root Raised Cosine filter. This special filter form is used to determine the channel power for some mobile radio standards.
<rbw>:	Resolution bandwidth Range of values: 10 Hz to 20 MHz, 50 MHz in 1, 2, 3, 5, 10 steps for <filter type> = NORMal. See filter table for <filter type> = CFILter and <filter type> = RRC. Possible combinations of filter type and filter bandwidth see table "List of available channel filters" in section "Setting Bandwidths and Sweep Time – Key BW".
<vbw>:	Video bandwidth Range of values: 1 Hz to 10 MHz in 1, 2, 3, 5, 10 steps. The value is ignored for <filter type> = CFILter or RRC
<meas time>:	Measurement time Range of values: 1us to 30s
<trigger level>:	Reserved. Must be set to 0.

### Returned values:

The query command returns a list of comma-separated values (CSV) which contains the power measurement results in floating-point format. The unit depends on the setting with CALC:UNIT.

#### Command

```
"SENSe:LIST:POWer? 935.2MHz,-20dBm,10dB,OFF,NORM,1MHz,3MHz,434us,0,
935.4MHz,-20dBm,10dB,OFF,NORM,30kHz,100kHz,434us,0,
935.6MHz,-20dBm,10dB,OFF,NORM,30kHz,100kHz,434us,0"
```

thus returns the following list, for example:

```
-28.3,-30.6,-38.1
```

If the command sequence is extended to

```
"SENSe:LIST:POWer:SET ON,ON,ON,IMM,POS,0,0"
```

```
"SENSe:LIST:POWer? 935.2MHz,-20dBm,10dB,OFF,NORM,1MHz,3MHz,434us,0,
935.4MHz,-20dBm,10dB,OFF,NORM,30kHz,100kHz,434us,0,
935.6MHz,-20dBm,10dB,OFF,NORM,30kHz,100kHz,434us,0"
```

the result list is extended to 3 results per frequency point (peak, RMS and average):

```
-28.3, -29.6, 1.5, -30.6, -31.9, 0.9, -38.1, -40.0, 2.3
```

**Examples:**

```
"SENSe:LIST:POWer 935.2MHz,-20dBm,10dB,OFF,NORM,1MHz,3MHz,434us,0,
935.4MHz,-20dBm,10dB,OFF,CFIL,30kHz,100kHz,434us,0,
935.6MHz,-20dBm,10dB,OFF,CFIL,30kHz,100kHz,434us,0"
```

performs a measurement sequence with the following settings:

Step	Freq. [MHz]	Ref Level	RF Att	OFF	Filtertyp	RBW	VBW	Meas Time	TRG Level (reserved)
1	935.2	-20 dBm	10 dB	OFF	Normal	1 MHz	3 MHz	434 us	0
2	935.4	-20 dBm	10 dB	10dB	Channel	30 kHz	100 kHz	434 us	0
3	935.6	-20 dBm	10 dB	20dB	Channel	30 kHz	100 kHz	434 us	0

```
"SENSe:LIST:POWer? 935.2MHz,-20dBm,10dB,OFF,NORM,1MHz,3MHz,434us,0,
935.4MHz,-20dBm,10dB,OFF,CFIL,30kHz,100kHz,434us,0,
935.6MHz,-20dBm,10dB,OFF,CFIL,30kHz,100kHz,434us,0"
```

performs the same measurement and returns the result list immediately after the last frequency point.

**Notes:** - *The measurement is performed in the time domain and therefore the span is set to 0 Hz. If the time domain is abandoned, the function is automatically switched off.*

- *The measurement is not compatible with other measurements, especially as far as marker, adjacent channel power measurement or statistics are concerned. The corresponding commands thus automatically deactivate the function.*

- *The function is only available in REMOTE operation. It is deactivated when switching the instrument back to LOCAL.*

**Characteristics:** \*RST value: --  
 SCPI: device-specific

**Mode:** A-F, A-T

[SENSe<1|2>:]LIST:POWer:SET <PEAK meas>,<RMS meas>,<AVG meas>,  
<trigger mode>,<trigger slope>,<trigger offset>,<gate length>

This command defines the constant settings for the list during multiple power measurement.

Parameters <PEAK meas>, <RMS meas> and <AVG meas> define, which measurements are to be performed at the same time at the frequency point. Correspondingly, one, two or three results per frequency point are returned for the SENS:LIST:POW? command. If all three parameters are set to OFF, the command generates an execution error.

**Parameter:**

<PEAK meas>:	ON	activates the measurement of the peak power (peak detector)
	OFF	deactivates the measurement of the peak power.
<RMS meas>:	ON	activates the measurement of the RMS power (RMS detector)
	OFF	deactivates the measurement of the RMS power.
<AVG meas>:	ON	activates the measurement of the average power (average detector)
	OFF	deactivates the measurement of the average power.
<trigger mode>:	Selection of the trigger source used for the list measurement.	
	Possible values: IMMEDIATE   VIDEO   EXTERNAL   IFPOWER	
<trigger slope>:	Used trigger slope.	
	Possible values: POSITIVE   NEGATIVE	
<trigger offset>:	Offset between the detection of the trigger signal and the start of the measurement at the next frequency point.	
	Range of values: 0 s, 125 ns to 100s	
<gate length>:	Gate length with Gated Sweep.	
	Range of values: 0 s, 125 ns to 100s	

**Note:**

- The value 0 s deactivates the use of GATED TRIGGER; other values activate the GATED TRIGGER function.
- Values <> 0 s are only possible if <trigger mode> is different from IMMEDIATE. Otherwise, an execution error is triggered.

**Returned values:**

The query command returns a list of comma-separated values (CSV) of the settings, ie

ON, ON, ON, IMM, POS, 0, 0

if the configuration has been set with the command

"SENSe:LIST:POWer:SET ON,ON,ON,IMM,POS,0,0"

**Examples:** "SENSe:LIST:POWer:SET ON,OFF,OFF,EXT,POS,10US,434US"  
"SENSe:LIST:POWer:SET ON,ON,ON,VID,NEG,10US,0"

**Characteristics:** \*RST values: ON, OFF, OFF, IMM, POS, 0S, 0S  
SCPI: device-specific

**Mode:** A-F, A-T

**[SENSe<1|2>:]LIST:POWer:RESult?**

This command queries the result of a previous list measurement as configured and initiated with `SENSe:LIST:POWer[:SEQuence]`. The measured results are output in a list of floating point values separated by commas. The unit of the results depends on the setting made with the `CALC:UNIT` command.

This command may be used to obtain measurement results in an asynchronous way, using the service request mechanism for synchronization with the end of the measurement.

If no measurement results are available, the command will return a query error.

**Example:**

'Configuration of the status reporting system for the generation of an SRQ on operation complete

\*ESE 1

\*SRE 32

'Configuring and starting the measurement

```
"SENSe:LIST:POWer      935.2MHz,-20dBm,10dB,OFF,NORM,1MHz,3MHz,434us,0,
                        935.4MHz,-20dBm,10dB,OFF,NORM,30kHz,100kHz,434us,0,
                        935.6MHz,-20dBm,10dB,OFF,NORM,30kHz,100kHz,434us,0;
                        *OPC"
```

'Further actions of the control computer during measurement

...

'Response to service request

On SRQ:

SENSe:LIST:POWer:RESult?

**Characteristics:** \*RST value: --  
SCPI: device-specific

**Mode:** A-F, A-T

**[SENSe<1|2>:]LIST:POWer:STATe OFF**

This command deactivates the list measurement.

**Example:** "SENSe:LIST:POWer:STATe OFF"

**Characteristics:** \*RST value: --  
SCPI: device-specific

**Mode:** A-F, A-T

## SENSe:MPOWER – Subsystem

The commands of this subsystem are used to determine the mean burst power or peak burst power for a given number of signal bursts, and for outputting the results in a list. Since all the settings required for a measurement are combined in a single command, the measurement speed is considerably higher than when using individual commands.

For measuring the signal bursts, the GATED SWEEP function is used in the time domain. The gate is controlled either by an external trigger signal or by the video signal. An individual trigger event is required for each burst to be measured. If an external trigger signal is used, the threshold is fixed to TTL level, while with a video signal the threshold can be set as desired.

The following graphics shows the relation between trigger time, trigger offset (for delayed gate opening) and measurement time.

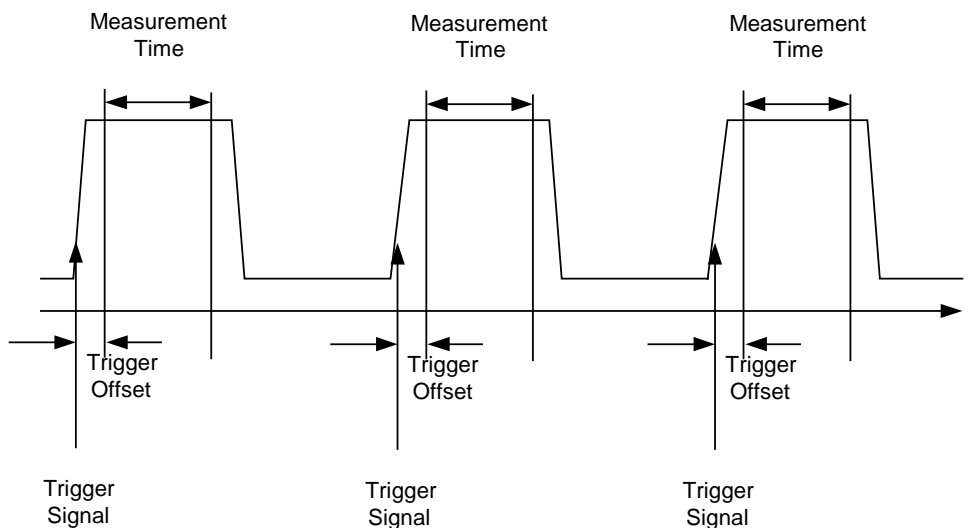

Depending on the settings made, the measurements are performed with the RMS detector for RMS power or the PEAK detector for peak power. For all these measurements, TRACE 1 of the selected system is used.

The setting parameters for this measurement are:

- analyzer frequency
- resolution bandwidth
- measurement time used for a single burst
- trigger source
- trigger level
- trigger offset
- type of power measurement (PEAK, MEAN)
- number of bursts to be measured

The commands of this subsystem can be used in two different ways:

1. Setting up the instrument and at the same time querying the result list: This method ensures the smallest delay between measurement and the output of the measured values, but requires the control computer to wait actively for the response of the instrument.
2. Setting up the instrument and querying the result list after synchronisation to the end of measurement: With this method the control computer can be used for other activities while the instrument is performing the measurement at the cost of additional time needed for synchronisation via service request.

COMMAND	PARAMETER	UNIT	COMMENT
[SENSe<1 2>] :MPOWer [:SEQuence]  :RESult [:LIST]? :MIN?	<numeric_value>, <numeric_value>, <numeric_value>, EXTernal   VIdeo, <numeric_value>, <numeric_value>, MEAN   PEAK, <numeric_value>	HZ, HZ, S, --, PCT, S, --, --	Query only Query only

**[SENSe<1|2>:MPOWer[:SEQuence]** <analyzer freq>,<rbw>,<meas time>,<trigger source>,<trigger level>,<trigger offset>,<type of meas>,<# of meas>

This command configures the instrument setup for multiple burst power measurement and starts a measurement sequence. When synchronizing the command with \*OPC, a service request is generated as soon as the defined number of individual measurements (# of meas) is reached.

To reduce the setting time, the setup is performed simultaneously for all selected parameters.

The command in the form of a query makes the instrument settings, performs the defined number of measurements and outputs the measurement results list.

**Parameters:**

- <analyzer freq>: Receive frequency for the burst signals to be measured (= center frequency in manual operation)  
Range: 0 Hz to max. frequency, depending on instrument model
- <rbw>: resolution bandwidth for the measurement  
Range: 10 Hz to 10 MHz in steps of 1, 3, 10
- <meas time>: Time span during which measurement samples are sampled for RMS / peak measurement The type of measurement is selected by <type of meas>.  
Range: 1us to 30s
- <trigger source>: trigger signal source. Possible settings:  
EXTernal The trigger signal is fed from the "Ext. Trigger/Gate" input on the rear of the unit.  
VIdeo The internal video signal is used as trigger signal.
- <trigger level>: Signal level at which the trigger becomes active. For <trigger source> = VIdeo this is the level of the video signal as a percentage of the diagram height. If <trigger source> = EXTernal is selected, the value entered here is ignored, as in this case the trigger input uses TTL levels.  
Range: 0 – 100PCT (<trigger source> = VIdeo)
- <trigger offset>: Offset between the detection of the trigger signal and the start of the measurement.  
Range: 125 ns to 100s
- <type of meas>: Determines whether mean power (RMS) or peak power (PEAK) is to be measured. The detector is selected accordingly.  
Possible values:MEAN, PEAK
- <# of meas>: Number of individual bursts to be measured.  
Range: 1 to 501



**Return values:**

The query command returns a list separated by commas (comma separated values = CSV), which contains the power measurement results in floating-point format. The unit used for the return values is always dBm.

The command "SENSe:MPOWer? 935.2MHz,1MHz,434us,VIDEO,50PCT,5us,MEAN,20" may, for instance, cause the following list to be returned:

18.3,18.6,18.1,18.0,17.9,18.3,18.6,18.1,18.0,17.9,18.3,18.6,18.1,18.0,17.9,18.3,18.6,18.1,18.0,17.9

**Examples:**

"SENSe:MPOWer 935.2MHz,1MHz,434us,VIDEO,50PCT,5us,MEAN,20"

performs a measurement sequence with the following settings:

Frequency = 935.2 MHz,  
 Resolution bandwidth = 1 MHz  
 Measurement time = 434  $\mu$ s  
 Trigger source = VIDEO  
 Trigger threshold = 50%  
 Trigger offset = 5  $\mu$ s  
 Type of measurement = MEAN power  
 No. of measurements = 20

"SENSe:MPOWer? 935.2MHz,1MHz,434us,VIDEO,50PCT,5us,MEAN,20"

performs the same measurement and in addition returns the results list immediately after completion of the last measurement.

**Notes:**

*The measurement function always uses trace 1 in the selected screen, and activates the selected screen.*

*Repeated use of the command without changes to its parameters (ie using the same settings again) will speed up the measurement since the previous hardware settings will be cached and therefore additional hardware settling times will be avoided. This also holds true if only part of the parameters (e.g. only the trigger delay) are changed, as in this case the rest of the parameters will be cached.*

*This measurement is not compatible with other measurements, especially as far as marker functions, adjacent-channel measurement or statistics are concerned. The corresponding functions are therefore automatically switched off. In return incompatible commands will automatically deactivate the multi burst power function.*

*The function is only available in the REMOTE operation. It is deactivated on switching back to LOCAL.*

**Characteristics:** \*RST value: --  
 SCPI: instrument-specific

**Mode:** A-F, A-T

**SENSe:MPOWer:RESult[:LIST]?**

This command queries the results of a multiple burst power measurement as configured and initiated with `SENSe:MPOWer[:SEquence]`. The results are output in a comma-separated list of floating point values. The unit used for the return values is always dBm.

This command may be used to obtain measurement results in an asynchronous way using the service request mechanism for synchronization with the end of the measurement.

If no measurement results are available, the command will return a query error.

**Example:**

```
*ESE 1           'Configuration of status reporting systems for the
*SRE 32         'generation of an SRQ on operation complete

SENSe:MPOWer
935.2MHz,1MHz,434us,VIDEO,50PCT,5us,MEAN,20;*OPC
           'Configuring and starting the measurement
...
           'Further actions of the control computer during
           'measurement
On SRQ:       'Response to service request
SENSe:MPOWer:RESult?
```

**Characteristics:** \*RST value: --  
SCPI: instrument-specific

**Mode:** A-F, A-T

**SENSe:MPOWer:RESult:MIN?**

This command queries the minimum power value in a multiple burst power measurement as configured and initiated with `SENSe:MPOWer[:SEquence]`. The unit used for the return values is always dBm.

If no measurement result is available, the command will return a query error.

**Example:**

```
*ESE 1           'Configuration of status reporting systems for the
*SRE 32         'generation of an SRQ on operation complete

SENSe:MPOWer
935.2MHz,1MHz,434us,VIDEO,50PCT,5us,MEAN,20;*OPC
           'Configuring and starting the measurement
...
           'Further actions of the control computer during
           'measurement
On SRQ:       'Response to service request
SENSe:MPOWer:RESult:MIN?
```

**Characteristics:** \*RST value: --  
SCPI: instrument-specific

**Mode:** A-F, A-T

## SENSe:POWer Subsystem

This subsystem controls the setting of the instrument's channel and adjacent channel power measurements. The measurement windows are selected by SENSE1 (screen A) and SENSE2 (screen B).

COMMAND	PARAMETERS	UNIT	COMMENT
[SENSe<1 2>] :POWer			
:ACHannel			
:SPACing			
[:ACHannel]	<numeric_value>	HZ	
:ALternate<1 2>	<numeric_value>	HZ	
:ACPairs	0   1   2   3		
:BANDwidth			
[:CHANnel]	<numeric_value>	HZ	
:ACHannel	<numeric_value>	HZ	
:ALternate<1 2>	<numeric_value>	HZ	
:BWIDth			
[:CHANnel]	<numeric_value>	HZ	
:ACHannel	<numeric_value>	HZ	
:ALternate<1 2>	<numeric_value>	HZ	
:MODE	ABSolute   RELative		
:REFerence			
:AUTO	ONCE		no query
:PRESet	ACPower   CPOWer   OBANdwidth   OBWidth		
:RLEVel			
:BANDwidth	<numeric_value>	PCT	
:BWIDth	<numeric_value>	PCT	
:HSPeed	<Boolean>		
:NCORrection	<Boolean>		
:TRACe	<numeric_value>	--	

### [SENSe<1|2>]:POWer:ACHannel:SPACing:ACHannel 100 Hz to 2000 MHz

This command defines the channel spacing of the adjacent channel to the TX channel. At the same time, the spacing of alternate adjacent channels 1 and 2 is set to the double or triple of the entered value.

The command is only available in the frequency domain (span > 0).

**Example:** "POW:ACH:SPAC:ACH 33kHz" 'Sets the spacing between the carrier signal and  
 '- the adjacent channel to 33 kHz  
 '- the alternate adjacent channel 1 to 66 kHz  
 '- the alternate adjacent channel 2 to 99 kHz

**Characteristics:** \*RST value: 14 kHz  
 SCPI: device-specific

**Mode:** A-F

**[SENSe<1|2>:]POWer:ACHannel:SPACing:ALTErnate<1|2>** 100 Hz to 2000 MHz

This command defines the spacing between the first (ALTErnate1) or the second alternate adjacent channel (ALTErnate2) and the TX channel. If the spacing to the alternate adjacent channel ALTErnate1 is modified, the spacing to alternate adjacent channel 2 is set to 1.5 times the entered value.

This command is only available in the frequency domain (span > 0).

**Example:** "POW:ACH:SPAC:ALT1 100kHz" 'Sets the spacing between TX channel and 'alternate adjacent channel 1 to 100 kHz and 'between TX channel and alternate adjacent 'channel 2 to 150 kHz.

**Characteristics:** \*RST value: 40 kHz (ALT1)  
60 kHz (ALT2)  
SCPI: device-specific

**Mode:** A-F

**[SENSe<1|2>:]POWer:ACHannel:ACPairs** 0 | 1 | 2 | 3

This command sets the number of adjacent channels (upper and lower channel in pairs). The figure 0 stands for pure channel power measurement.

The command is only available in the frequency domain (span > 0).

**Example:** "POW:ACH:ACP 3" 'Sets the number of adjacent channels to 3, ie the 'adjacent channel and alternate adjacent channels 1 and '2 are switched on.

**Characteristics:** \*RST value: 1  
SCPI: device-specific

**Mode:** A-F

**[SENSe<1|2>:]POWer:ACHannel:BANDwidth|BWIDth[:CHANnel]** 100 Hz to 1000 MHz

This command sets the channel bandwidth of the radio communication system. The bandwidths of adjacent channels are not influenced by this modification (in contrast to the FSE family).

With `SENSe:POW:HSP ON` the steep-edged channel filters from the table "List of available channel filters" in Section "Setting Bandwidths and Sweep Time – Key *BW*" are available.

**Example:** "POW:ACH:BWID 30kHz" 'Sets the bandwidth of the TX channel to '30 kHz.

**Characteristics:** \*RST value: 14 kHz  
SCPI: device-specific

**Mode:** A-F

**[SENSe<1|2>:]POWer:ACHannel:BANDwidth|BWIDth:ACHannel** 100 Hz to 1000 MHz

This command defines the channel bandwidth of the adjacent channel of the radio transmission system. If the bandwidth of the adjacent channel is changed, the bandwidths of all alternate adjacent channels are automatically set to the same value.

With `SENSe:POW:HSP` ON the steep-edged channel filters from the table "List of available channel filters" in Section "Setting Bandwidths and Sweep Time – Key *BW*" are available.

**Example:**           "POW:ACH:BWID:ACH 30kHz"   'Sets the bandwidth of all adjacent channels to 30 kHz.

**Characteristics:** \*RST value:   14 kHz  
SCPI:               device-specific

**Mode:**            A-F

**[SENSe<1|2>:]POWer:ACHannel:BANDwidth|BWIDth:ALTErnate<1|2>** 100 Hz to 1000 MHz

This command defines the channel bandwidth of the first/second alternate adjacent channel of the radio transmission system. If the channel bandwidth of alternate adjacent channel 1 is changed, the bandwidth of alternate adjacent channel 2 is automatically set to the same value.

With `SENSe:POW:HSP` ON the steep-edged channel filters from the table "List of available channel filters" in Section "Setting Bandwidths and Sweep Time – Key *BW*" are available.

**Example:**           "POW:ACH:BWID:ALT2 30kHz"

**Characteristics:** \*RST value:   14 kHz  
SCPI:               device-specific

**Mode:**            A-F

**[SENSe<1|2>:]POWer:ACHannel:MODE** ABSolute | RELative

This command toggles between absolute and relative adjacent channel measurement.

For the relative measurement the reference value is set to the currently measured channel power by command `SENSe:POWer:ACHannel:REFerence:AUTO ONCE`.

The command is only available in the frequency domain (span > 0).

**Example:**           "POW:ACH:MODE REL"

**Characteristics:** \*RST value:   ABSolute  
SCPI:               device-specific

**Mode:**            A-F

**[SENSe<1|2>:]POWer:ACHannel:REFerence:AUTO** ONCE

This command sets the reference value for the relative measurement to the currently measured channel power.

The command is only available in the frequency domain (span > 0).

**Example:**           "POW:ACH:REF:AUTO ONCE"

**Characteristics:** \*RST value:   -  
SCPI:               device-specific

**Mode:**            A-F

This command is an event and is therefore not assigned an \*RST value and has no query.



**[SENSe<1|2>:]POWer:HSPeed ON | OFF**

This command switches on or off the high-speed channel/adjacent channel power measurement. The measurement itself is performed in the time domain on the center frequencies of the individual channels. The command automatically switches to the time domain and back.

Depending on the selected mobile radio standard, weighting filters with  $\sqrt{\cos}$  characteristic or very steep-sided channel filters are used for band limitation.

The command is only available in the frequency domain (span > 0).

**Example:** "POW:HSP ON"

**Characteristics:** \*RST value: OFF  
SCPI: device-specific

**Mode:** A-F

**[SENSe<1|2>:]POWer:TRACe 1 to 3**

This command assigns the channel/adjacent channel power measurement to the indicated trace in the selected measurement window. The corresponding trace must be active, ie its state must be different from blank.

**Note:** *The measurement of the occupied bandwidth (OBW) is performed on the trace on which marker 1 is positioned. To evaluate another trace, marker 1 must be positioned to another trace with CALCulate:MARKer:TRACe.*

**Example:** "POW:TRAC 2" 'Assigns the measurement in screen A to trace 2.  
"SENS2:POW:TRAC 3" 'Assigns the measurement in screen B to trace 3.

**Characteristics:** \*RST value: -  
SCPI: device-specific

**Mode:** A

## SENSe:ROSCillator Subsystem

This subsystem controls the reference oscillator. The numeric suffix in SENSe is irrelevant for the commands of this subsystem.

COMMAND	PARAMETERS	UNIT	COMMENT
[SENSe<1 2>] :ROSCillator :SOURce [:INTernal] :TUNe :SAVe	INTernal   EXTernal  <numeric_value>	--	no query

### [SENSe<1|2>]:ROSCillator:SOURce INTernal | EXTernal

This command controls selection of the reference oscillator.

If the external reference oscillator is selected, the reference signal must be connected to the rear panel of the instrument.

**Example:** "ROSC:SOUR EXT"

**Characteristics:** \*RST value: –  
SCPI: conforming

**Mode:** all

### [SENSe<1|2>]:ROSCillator[:INTernal]:TUNE 0 to 4095

This command defines the value for the tuning of the internal reference oscillator.

The reference oscillator should be tuned only if an error has been detected in the frequency accuracy check. After rebooting the instrument, the factory-set reference frequency or the previously saved reference frequency is restored.

**Note:** This command is only available at service level 1.

**Example:** "ROSC:TUN 128"

**Characteristics:** \*RST value: –  
SCPI: device-specific

**Mode:** all

### [SENSe<1|2>]:ROSCillator[:INTernal]:TUNE:SAVe

This command saves the new value for the tuning of the internal reference oscillator. The factory-set value in the EEPROM is overwritten.

**Note:** This command is only available at service level 1.

**Example:** "ROSC:TUN:SAV"

**Characteristics:** \*RST value: –  
SCPI: device-specific

**Mode:** all



## SENSe:SCAN - Subsystem

This subsystem controls the parameters for the receiver scan data. The numeric suffix in SENSE<1|2> is not significant.

COMMAND	PARAMETER	UNIT	COMMENT
[SENSe<1 2>] :SCAN<1 to 10>			Receiver Mode
:START	<numeric_value>	HZ	
:STOP	<numeric_value>	HZ	
:STEP	<numeric_value>	HZ	
:TIME	<numeric_value>	S	
:BANDwidth			
:RESolution	<numeric_value>	HZ	
:INPut			
:ATTenuation	<numeric_value>	DB	
:AUTO	<Boolean>	--	
:GAIN			
:STATE	<Boolean>	--	
:AUTO	<Boolean>	--	
:RANGes			
[:COUNT]	<numeric_value>	--	

### [SENSe<1|2>]:SCAN<1 to 10>:START $f_{min}$ to $f_{max}$

This command defines the start frequency of the selected receiver scan range.

**Example:** "SCAN1:STAR 50kHz" 'Sets the start frequency of scan range 1 to 50 kHz

**Characteristics:** \*RST value: 150 kHz (range1)  
30 MHz (range2)  
SCPI: device-specific

**Mode:** R

The numeric suffix in SENSE<1|2> is not significant.

### [SENSe<1|2>]:SCAN<1 to 10>:STOP $f_{min}$ to $f_{max}$

This command defines the stop frequency of the selected receiver scan range.

**Example:** "SCAN1:STOP 200kHz" 'Sets the stop frequency of scan range 1 to 200 kHz

**Characteristics:** \*RST value: 30 MHz (range1)  
1 GHz (range2)  
SCPI: device-specific

**Mode:** R

The numeric suffix in SENSE<1|2> is not significant.

**[SENSe<1|2>:SCAN<1 to 10>:STEP** 1 Hz to  $f_{\max}$  | 0.1 % to 100 %

This command defines the step size for the frequency of the selected receiver scan range with step mode LIN or LOG (command `SENSe:SWEep:SPACing LIN | LOG`). With step mode AUTO (command `SENSe:SWEep:SPACing AUTO`), the step width cannot be set

**Example:** "SCAN1:STEP 100Hz" 'Sets the step size for the frequency of scan  
'range 1 to 100 Hz

**Characteristics:** \*RST value: 4 kHz (range 1)  
40 kHz (range 2)  
SCPI: device-specific

**Mode:** R

The numeric suffix in `SENSe<1|2>` is not significant.

**[SENSe<1|2>:SCAN<1 to 10>:BANDwidth:RESolution** <numeric\_value>

This command defines the bandwidth for the selected receiver scan range. See command `SENSe:BANDwidth:RESolution` for range of values.

**Example:** "SCAN1:BAND:RES 1MHz" 'Sets the resolution bandwidth of scan  
'range 1 to 1 MHz

**Characteristics:** \*RST value: 9 kHz (range 1)  
120 kHz (range 2)  
SCPI: device-specific

**Mode:** R

The numeric suffix in `SENSe<1|2>` is not significant.

**[SENSe<1|2>:SCAN<1 to 10>:TIME** 100  $\mu$ s to 100 s

This command defines the measurement time of the receiver subscan.

**Example:** "SCAN1:TIME 1 ms" 'Sets the measurement time of scan  
'range 1 to 1 ms

**Characteristics:** \*RST value: 1 ms (range 1)  
100 $\mu$ s (range 2)  
SCPI: device-specific

**Mode:** R

The numeric suffix in `SENSe<1|2>` is not significant.

**[SENSe<1|2>:SCAN<1 to 10>:INPut:ATTenuation** dB<sub>min</sub> to dB<sub>max</sub>

This command defines the RF attenuation for the selected receiver scan range.

**Example:** "SCAN1:INP:ATT 30dB" 'Sets the input attenuation of scan  
'range 1 to 1 ms

**Characteristics:** \*RST value: 10 dB  
SCPI: device-specific

**Mode:** R

The numeric suffix in `SENSe<1|2>` is not significant.

**[SENSe<1|2>:]SCAN<1 to 10>:INPut:ATTenuation:AUTO ON | OFF**

This command switches on or off the autoranging function in the selected receiver scan range.

**Example:** "SCAN1:INP:ATT:AUTO ON" 'Activates the auto ranging function for scan range 1

**Characteristics:** \*RST value: OFF  
SCPI: device-specific

**Mode:** R

The numeric suffix in SENSe<1|2> is not significant.

**[SENSe<1|2>:]SCAN<1 to 10>:INPut:GAIN:STATE ON | OFF**

This command switches on or off the preamplifier in the selected receiver scan range.

**Example:** "SCAN1:INP:GAIN:STAT ON" 'Activates the preamplifier for scan range 1

**Characteristics:** \*RST value: OFF  
SCPI: device-specific

**Mode:** R

The numeric suffix in SENSe<1|2> is not significant.

**[SENSe<1|2>:]SCAN<1 to 10>:INPut:GAIN:AUTO ON | OFF**

This command includes the preamplifier in the autoranging function of the selected receiver scan range.

**Example:** "SCAN1:INP:GAIN:AUTO ON" 'Includes the preamplifier in the autoranging function for scan range 1

**Characteristics:** \*RST value: OFF  
SCPI: device-specific

**Mode:** R

The numeric suffix in SENSe<1|2> is not significant.

**[SENSe<1|2>:]SCAN:RANGes[:COUNT] 1 to 10**

This command determines the number of ranges. With setting 0, the scan is performed using the current receiver settings and not the settings defined with commands SENSe:SCAN: . . .

**Example:** "SCAN:RANG:COUN 3" 'Sets the number of ranges to 3

**Characteristics:** \*RST value: 2  
SCPI: device-specific

**Mode:** R

The numeric suffix in SENSe<1|2> is not significant.

## SENSe:SWEep Subsystem

This subsystem controls the sweep parameters. The measurement windows are selected by SENSe1 (screen A) and SENSe2 (screen B).

COMMAND	PARAMETERS	UNIT	COMMENT
[SENSe<1 2>] :SWEep			
:TIME	<numeric_value>	S	
:AUTO	<Boolean>	--	
:FMEasurement	<numeric_value>	S	
:COUNT	<numeric_value>	--	
:EGATe	<Boolean>	--	
:TYPE	LEVel EDGE	--	
:POLarity	POSitive NEGative	--	
:HOLDoff	<numeric_value>	S	
:LENGth	<numeric_value>	S	
:SOURce	EXTernal   IFPower		
:SPACing	LINear   LOGarithmic   AUTO		

**[SENSe<1|2>]:SWEep:TIME** 100µs to 100s | 15 sec (receiver) | 2,5ms to 16000s (frequency domain) | 1µs to 16000s (time domain)

This command defines the scan or sweep time. ,

For receiver single scan, the available time value range is 100 µs to 100 s in 1-2-5 steps. In analyzer mode, the available time values are different in the frequency domain (2.5 ms to 16000s with span > 0) and in the time domain (1µs to 16000s with span = 0).

If SWEep:TIME is directly programmed, automatic coupling to resolution bandwidth and video bandwidth is switched off.

**Example:** "SWE:TIME 10s"

**Characteristics:** \*RST value - (AUTO is set to ON)  
SCPI: conforming

**Mode:** R, A

**[SENSe<1|2>]:SWEep:TIME:AUTO** ON | OFF

This command controls the automatic coupling of the sweep time to the frequency span and bandwidth settings.

If SWEep:TIME is directly programmed, automatic coupling is switched off.

**Example:** "SWE:TIME:AUTO ON" 'Switches on the coupling to frequency span and bandwidths.

**Characteristics:** \*RST value: ON  
SCPI: conforming

**Mode:** A

**[SENSe<1|2>:]SWEep:TIME:FMEasurement <numeric\_value>:**

This command defines the measurement time in which the values indicated in the peak list (final measurement values) are re-checked.

**Example:** "SWE:TIME:FME 0.01"

**Characteristics:** \*RST value: 1s  
SCPI: device specific

**Mode:** R

**[SENSe<1|2>:]SWEep:COUNt 0 to 32767**

This command defines the number of scans started with single scan in receiver mode,

In analyzer mode, this command defines the number of sweeps started with single sweep, which are used for calculating the average or maximum value. In average mode, the value 0 defines a continuous averaging of measurement data over 10 sweeps.

**Example:** "SWE:COUN 64" 'Sets the number of sweeps to 64.  
"INIT:CONT OFF" 'Switches to single-sweep mode.  
"INIT;\*WAI" 'Starts a sweep and waits for its end.

**Characteristics:** \*RST value: 0  
SCPI: conforming

**Mode:** R, A

**[SENSe<1|2>:]SWEep:EGATe ON | OFF**

This command switches on/off the sweep control by an external gate signal. If the external gate is selected the trigger source is automatically switched to EXTERNAL as well.

In case of measurement with external gate, the measured values are recorded as long as the gate is opened. There are two possibilities:

1. The gate is edge-triggered ("SWEep:EGATe:TYPE EDGE"):
 

After detection of the set gate signal edge, the gate remains open until the gate delay (SWEep:EGATe:HOLDoff) has expired.
2. The gate is level-triggered ("SWEep:EGATe:TYPE LEVEL"):
 

After detection of the gate signal, the gate remains open until the gate signal disappears.

A delay between applying the gate signal and the start of recording measured values can be defined with SWEep:EGATe:HOLDoff.

During a sweep the gate can be opened and closed several times. The synchronization mechanisms with \*OPC, \*OPC? and \*WAI remain completely unaffected.

The sweep end is detected when the required number of measurement points (501 in analyzer mode) has been recorded.

**Example:** "SWE:EGAT ON" 'Switches on the external gate mode.  
"SWE:EGAT:TYPE EDGE" 'Switches on the edge-triggered mode.  
"SWE:EGAT:HOLD 100US" 'Sets the gate delay to 100 µs.  
"SWE:EGAT:LEN 500US" 'Sets the gate opening time to 500 µs.  
"INIT;\*WAI" 'Starts a sweep and waits for its end.

**Characteristics:** \*RST value: OFF  
SCPI: device-specific

**Mode:** A

**[SENSe<1|2>:]SWEep:EGATe:TYPE** LEVEL | EDGE

This command sets the type of triggering (level or edge) by the external gate signal.

The gate opening time cannot be defined with the parameter EGATe:LENGth in case of level triggering. The gate is closed when the gate signal disappears.

**Example:** "SWE:EGAT:TYPE EDGE"

**Characteristics:** \*RST value: EDGE  
SCPI: device-specific

**Mode:** A

**[SENSe<1|2>:]SWEep:EGATe:POLarity** POSitive | NEGative

This command determines the polarity of the external gate signal. The setting is valid both for the edge of an edge-triggered signal and the level of a level-triggered signal.

**Example:** "SWE:EGAT:POL POS"

**Characteristics:** \*RST value: POSitive  
SCPI: device-specific

**Mode:** A

**[SENSe<1|2>:]SWEep:EGATe:HOLDoff** 125 ns to 100 s

This command defines the delay time between the external gate signal and the continuation of the sweep.

**Example:** "SWE:EGAT:HOLD 100us"

**Characteristics:** \*RST value: 0s  
SCPI: device-specific

**Mode:** A

**[SENSe<1|2>:]SWEep:EGATe:LENGth** 0 to 100 s

In case of edge triggering, this command determines the time interval during which the instrument sweeps.

**Example:** "SWE:EGAT:LENG 10ms"

**Characteristics:** \*RST value: 0s  
SCPI: device-specific

**Mode:** A

**[SENSe<1|2>:]SWEEP:EGATE:SOURCE** EXTernal | IFPower | RFPower

This command toggles between external gate signal and IF power signal as a signal source for the gate mode. If an IF power signal is used, the gate is opened as soon as a signal at > -20 dBm is detected within the IF path bandwidth (10 MHz).

**Notes:** Selection RFPower is only available with option FSP-B6 (TV- and RF-Trigger).

**Example:** "SWE:EGAT:SOUR IFP" 'Switches the gate source to IF power.

**Characteristics:** \*RST value: IFPower  
SCPI: device-specific

**Mode:** A

**[SENSe<1|2>:]SWEEP:SPACING** LINear | LOGarithmic | AUTO

This command toggles between linear and logarithmic step modes of the receiver. In analyzer mode, it toggles between linear and logarithmic sweep.

**Example:** "SWE:SPAC LOG"

**Features:** \*RST value: LIN  
SCPI: conforming

**Modes:** R, A, VA

The frequency-axis is set to linear or logarithmic scaling accordingly.

## SENSe:TV - Subsystem

This subsystem controls the TV trigger part of option FSP-B6 (TV and RF trigger). The setup of the individual trigger parameters is included in subsystem *TRIGger*.

COMMAND	PARAMETERS	UNIT	COMMENT
[SENSe<1 2>] :TV [:STATe] :CCVS	<Boolean> INTernal   EXTernal	-- --	Option TV- and RF trigger

### [SENSe<1|2>:]TV[:STATe]ON | OFF

This command switches triggering on TV signals on or off.

**Example:** "TV ON"

**Characteristics:** \*RST-Wert: OFF  
SCPI: gerätespezifisch

**Modes:** A-T

This command is only available with option FSP-B6 (TV- and RF-Trigger).

### [SENSe<1|2>:]TV:CCVS INTernal | EXTernal

This command selects between an internal and an external CCVS signal as TV demodulator input signal.

**Example:** "TV EXT"

**Characteristics:** \*RST-Wert: INT  
SCPI: gerätespezifisch

**Modes:** A-T

This command is only available with option FSP-B6 (TV- and RF-Trigger).



# SOURce Subsystem

The SOURce subsystem controls the output signals of the instrument if the options tracking generator (FSP-B9) or External Generator Control (FSP-B10) are installed. The measurement window is selected by SOURce1 (screen A) and SOURce2 (screen B).

## Internal Tracking Generator

COMMAND	PARAMETERS	UNIT	COMMENT
SOURce<1 2>			Tracking generator option
:AM			
:STATe	<Boolean>		
:DM			
:STATe	<Boolean>		
:FM			
:STATe	<Boolean>		
:DEVIation	<numeric_value>	HZ	
:FREQuency			
:OFFSet	<numeric_value>	HZ	
:POWer			
[:LEVel]			
[:IMMediate]			
[:AMPLitude]	<numeric_value>	DBM	
:OFFSet	<numeric_value>	DB	

### SOURce<1|2>:AM:STATe ON | OFF

This command switches on or off the external amplitude modulation of the tracking generator in the selected measurement window.

External I/Q modulation is switched off, if active. This command is only valid in conjunction with the tracking generator option FSP-B9.

**Example:** "SOUR:AM:STAT ON " 'Switches on the external amplitude modulation of the tracking generator for screen A.

**Characteristics:** \*RST value: OFF  
SCPI: conforming

**Modes:** all

### SOURce<1|2>:DM:STATe ON | OFF

This command switches on or off the external I/Q modulation of the tracking generator in the selected measurement window.

External AM and external FM are switched off, if active. This command is only valid in conjunction with the tracking generator option FSP-B9.

**Example:** "SOUR2:DM:STAT ON " 'Switches on the external I/Q modulation of the tracking generator for screen B.

**Characteristics:** \*RST- value: OFF  
SCPI: conforming

**Modes:** all

**SOURce<1|2>:FM:STATe** ON | OFF

This command switches on or off the external frequency modulation of the tracking generator in the selected measurement window.

External I/Q modulation is switched off, if active. This command is only valid in conjunction with the tracking generator option FSP-B9.

**Example:** "SOUR:FM:STAT ON " 'Switches on the external frequency modulation of the tracking generator for screen A.

**Characteristics:** \*RST value: OFF  
SCPI: conforming

**Modes:** all

**SOURce<1|2>:FM:DEVIation** 100Hz to 10MHz

This command defines the maximum frequency deviation at 1 V input voltage at the FM input of the tracking generator.

The possible value range is 100 Hz to 10 MHz in steps of one decade.

This command is only available in connection with the Tracking Generator Option FSP-B9.

**Example:** "SOUR:FM:DEV 1MHz " 'Sets the maximum frequency deviation of the tracking generator for screen A to 1 MHz.

**Characteristics:** \*RST value: 100 Hz  
SCPI: conforming

**Operating mode:** all

**SOURce<1|2>:FREQuency:OFFSet** -150MHz to 150MHz

This command defines a frequency offset of the tracking generator for the indicated measurement window. Frequency-converting DUTs can be measured with this setting.

The possible value range is -150 MHz to 150 MHz. It should be noted that the terms (start frequency - tracking frequency offset) and (stop frequency - tracking frequency offset) are both > 1 kHz or both < -1 kHz.

External I/Q modulation is switched off, if active. This command is only valid in conjunction with the tracking generator option FSP-B9.

**Example:** "SOUR:FREQ:OFFS 10MHz " 'Switches on the frequency offset of the tracking generator for screen A to 10 MHz.

**Characteristics:** \*RST value: 0 Hz  
SCPI: conforming

**Modes:** all

**SOURce<1|2>:POWer[:LEVel][:IMMediate][:AMPLitude] <numeric\_value>**

This command defines the output level of the tracking generator in the current measurement window.

This command is only valid in conjunction with the tracking generator option FSP-B9.

**Parameter:** <numeric value> ::= -30dBm to 0dBm. In the external tracking generator mode the limits depend on the type of the generator used.

**Example:** "SOUR:POW -20dBm" 'Sets the tracking generator level in screen A to -20 dBm.

**Characteristics:** \*RST- value: -20 dBm  
SCPI: conforming

**Modes:** all

**SOURce<1|2>:POWer[:LEVel][:IMMediate]:OFFSet -200dB to +200dB**

This command defines a level offset for the tracking generator level. Thus, for example, attenuators or amplifiers at the output of the tracking generator can be taken into account for the setting.

This command is only valid in conjunction with the tracking generator option FSP-B9.

**Example:** "SOUR:POW:OFFS -10dB" 'Sets the level offset of the tracking generator in 'screen A to - 20 dBm.

**Characteristics:** \*RST- value: 0dB  
SCPI: conforming

**Modes:** all

## SOURce:EXTernal Subsystem

The SOURce:EXTernal subsystem controls the operation of the unit with option Ext. Generator Control (B10). The commands are only valid for the selected window, with SOURce1 changing the setting in screen A and SOURce2 the setting in screen B.

The selection of the external generator 1 or 2 is via EXTernal<1|2>.

**Note:** The commands of the SOURce:EXTernal subsystem assume that the addressed generator was correctly configured with the commands of subsystem SYSTEM:COMMunicate:GPIB:RDEvice:GENerator.

If no external generator is selected, if the IECBUS address is not correct or the generator is not ready for operation, an execution error will be generated.

COMMAND	PARAMETER	UNIT	COMMENT
SOURce<1 2>			
:EXTernal<1 2> [:STATe]	<Boolean>		Ext. generator option
:FREQuency :OFFSet [:FACTor]	<numeric_value>	HZ	
:NUMerator :DENominator	<numeric_value> <numeric_value>		
:SWEep [:STATe]	<Boolean>		
:POWer [:LEVel]	<numeric_value>	DBM	
:ROSCillator [:SOURce]	INTernal   EXTernal		

### SOURce<1|2>:EXTernal<1|2>[:STATe] ON | OFF

This command activates or deactivates the external generator selected with SOUR:EXT<1|2>:FREQ:SWE ON in the selected window.

The suffix behind EXTernal is irrelevant for this command.

This command is only available in connection with option Ext. Generator Control B10.

**Example:**

```
"SYST:COMM:RDEV:GEN1:TYPE 'SMP02'"
'Selects SMP02 as generator 1.
```

```
"SYST:COMM:RDEV:GEN1:LINK TTL"
'Selects IECBUS + TTL link as interface.
```

```
"SYST:COMM:RDEV:GEN1:ADDR 28"
'Sets the generator address to 28.
```

```
"SOUR:EXT1:FREQ:SWE ON"
'Activates the frequency sweep for generator 1.
```

```
"SOUR:EXT ON"
'Activates the external generator
```

**Characteristics:** \*RST value: OFF  
SCPI: device-specific

**Mode:** all

**SOURce<1|2>:EXTernal<1|2>:FREQuency[:FACTor]:DENominator <numeric\_value>**

This command defines the denominator of the factor with which the analyzer frequency is multiplied in order to obtain the transmit frequency of the selected generator 1 or 2 in the selected window.

**Note:** *Select the multiplication factor in a way that the frequency range of the generator is not exceeded by the following formula*

$$F_{Generator} = F_{Analyzer} * \frac{Numerator}{Denominator} + F_{Offset}$$

*if applied to the start and stop frequency of the analyzer.*

*This command is only valid in combination with option Ext. Generator Control B10.*

**Example:** " SOUR : EXT : FREQ : NUM 4 "

" SOUR : EXT : FREQ : DEN 3 "

'Sets a multiplication factor of 4/3, ie the 'transmit frequency of the generator is '4/3 times the analyzer frequency.

**Characteristics:** \*RST value: 1  
SCPI: device-specific

**Mode:** all

**SOURce<1|2>:EXTernal<1|2>:FREQuency[:FACTor]:NUMerator <numeric\_value>**

This command defines the numerator of the factor with which the analyzer frequency is multiplied to obtain the transmit frequency of the selected generator 1 or 2 in the selected window.

**Note:** *Select the multiplication factor so that the frequency range of the generator is not exceeded if the following formula*

$$F_{Generator} = F_{Analyzer} * \frac{Numerator}{Denominator} + F_{Offset}$$

*is applied to the start and stop frequency of the analyzer.*

*This command is only valid in combination with option Ext. Generator Control B10.*

**Example:** " SOUR : EXT : FREQ : NUM 4 "

" SOUR : EXT : FREQ : DEN 3 "

'Sets a multiplication factor of 4/3, ie the 'transmit frequency of the generator is '4/3 times the analyzer frequency.

**Characteristics:** \*RST value: 1  
SCPI: device-specific

**Mode:** all

**SOURce<1|2>:EXTernal<1|2>:FREQuency:OFFSet** <numeric\_value>

This command defines the frequency offset of the selected generator 1 or 2 with reference to the receive frequency in the selected window.

**Note:** Select the frequency offset of the generator so that the frequency range of the generator is not exceeded with the following formula

$$F_{Generator} = F_{Analyzer} * \frac{Numerator}{Denominator} + F_{Offset}$$

applied to the start and stop frequency of the analyzer.

This command is only valid in combination with option Ext. Generator Control B10.

**Example:** "SOUR:EXT:FREQ:OFFS 1GHZ" 'Sets a frequency offset of the  
'generator transmit frequency  
'compared to the analyzer receive  
'frequency of 1 GHz.

**Characteristics:** \*RST value: 0 Hz  
SCPI: device-specific

**Mode:** all

**SOURce<1|2>:EXTernal<1|2>:FREQuency:SWEep[:STATe]** ON | OFF

This command activates or deactivates the frequency sweep for generator 1 or 2 in the selected window.

This command is only valid in combination with option Ext. Generator Control B10.

**Example:** "SOUR:EXT1:FREQ:SWE ON" 'Activates the frequency sweep for ext.  
generator 1.

**Characteristics:** \*RST value: OFF  
SCPI: device-specific

**Mode:** all

**SOURce<1|2>:EXTernal<1|2>:POWEr[:LEVEl]** <numeric\_value>

This command sets the output power of the selected generator 1 or 2 in the selected window.

This command is only valid in combination with option Ext. Generator Control B10.

**Example:** "SOUR:EXT:POW -30dBm" 'Sets the generator level to -30 dBm

**Characteristics:** \*RST value: -20 dBm  
SCPI: device-specific

**Mode:** all

**SOURce<1|2>:EXTernal<1|2>:ROSCillator[:SOURce]** INTernal | EXTernal

This command switches between external and internal reference oscillator for the frequency processing of external generator 1 and 2.

The command always works on both generators. Therefore, the numeric suffix in EXTernal<1|2> is not significant.

This command is only valid in combination with option Ext. Generator Control B10.

**Example:**            "SOUR:EXT:ROSC EXT"            'switches to external reference oscillator

**Characteristics:** \*RST value:    INT  
SCPI:                device-specific

**Mode:**             all

# STATus Subsystem

The STATus subsystem contains the commands for the status reporting system (see Chapter 5, Status Reporting System"). \*RST does not influence the status registers.

COMMAND	PARAMETERS	UNIT	COMMENT
STATus			
:OPERation			
[:EVENT]?	--	--	
:CONDition?	--	--	
:ENABle	0 to 65535	--	
:PTRansition	0 to 65535	--	
:NTRansition	0 to 65535	--	
:PRESet	--	--	
:QUEStionable			
[:EVENT]?	--	--	
:CONDition?	--	--	
:ENABle	0 to 65535	--	
:PTRansition	0 to 65535	--	
:NTRansition	0 to 65535	--	
:POWer			
[:EVENT]?	--	--	
:CONDition?	--	--	
:ENABle	0 to 65535	--	
:PTRansition	0 to 65535	--	
:NTRansition	0 to 65535	--	
:LIMit<1 2>			
[:EVENT]?	--	--	
:CONDition?	--	--	
:ENABle	0 to 65535	--	
:PTRansition	0 to 65535	--	
:NTRansition	0 to 65535	--	
:LMARgin<1 2>			
[:EVENT]?	--	--	
:CONDition?	--	--	
:ENABle	0 to 65535	--	
:PTRansition	0 to 65535	--	
:NTRansition	0 to 65535	--	
:SYNC			
[:EVENT]?	--	--	
:CONDition?	--	--	
:ENABle	0 to 65535	--	
:PTRansition	0 to 65535	--	
:NTRansition	0 to 65535	--	
:ACPLimit			
[:EVENT]?	--	--	
:CONDition?	--	--	
:ENABle	0 to 65535	--	
:PTRansition	0 to 65535	--	
:NTRansition	0 to 65535	--	



COMMAND	PARAMETERS	UNIT	COMMENT
:FREQuency		--	
[:EVENT]?	--	--	
:CONDition?	--	--	
:ENABle	0 to 65535	--	
:PTRansition	0 to 65535	--	
:NTRansition	0 to 65535	--	
:TRANsducer			
[:EVENT]?	--	--	
:CONDition?	--	--	
:ENABle	0 to 65535	--	
:PTRansition	0 to 65535	--	
:NTRansition	0 to 65535	--	
:QUEue?	--	--	
[:NEXT]?	--	--	

**STATus:OPERation[:EVENT]?**

This command queries the contents of the EVENT section of the STATus:OPERation register. The contents of the EVENT section are deleted after readout.

**Example:** "STAT:OPER?"

**Characteristics:** \*RST value: –  
SCPI: conforming

**Mode:** all

**STATus:OPERation:CONDition?**

This command queries the CONDition section of the STATus:OPERation register. Readout does not delete the contents of the CONDition section. The value returned reflects the current hardware status.

**Example:** "STAT:OPER:COND?"

**Characteristics:** \*RST value: –  
SCPI: conforming

**Mode:** all

**STATus:OPERation:ENABle 0 to 65535**

This command sets the bits of the ENABle section of the STATus:OPERation register. The ENABle register selectively enables the individual events of the associated EVENT section for the summary bit in the status byte.

**Example:** "STAT:OPER:ENAB 65535"

**Characteristics:** \*RST value: –  
SCPI: conforming

**Mode:** all

**STATus:OPERation:PTRansition** 0 to 65535

This command sets the edge detectors of all bits of the STATus:OPERation register from 0 to 1 for the transitions of the CONDition bit.

**Example:** "STAT:OPER:PTR 65535"

**Characteristics:** \*RST value: –  
SCPI: conforming

**Mode:** all

**STATus:OPERation:NTRansition** 0 to 65535

This command sets the edge detectors of all bits of the STATus:OPERation register from 1 to 0 for the transitions of the CONDition bit.

**Example:** "STAT:OPER:NTR 65535"

**Characteristics:** \*RST value: –  
SCPI: conforming

**Mode:** all

**STATus:PRESet**

This command resets the edge detectors and ENABLE parts of all registers to a defined value. All PTRansition parts are set to FFFFh, ie all transitions from 0 to 1 are detected. All NTRansition parts are set to 0, ie a transition from 1 to 0 in a CONDition bit is not detected. The ENABLE part of the STATus:OPERation and STATus:QUESTionable registers are set to 0, ie all events in these registers are not passed on.

**Example:** "STAT:PRES"

**Characteristics:** \*RST value: –  
SCPI: conforming

**Mode:** all

**STATus:QUESTionable[:EVENT]?**

This command queries the contents of the EVENT section of the STATus:QUESTionable register. The contents of the EVENT section are deleted after the readout.

**Example:** "STAT:QUES?"

**Characteristics:** \*RST value: –  
SCPI: conforming

**Mode:** all

**STATus:QUESTionable:CONDition?**

This command queries the CONDition section of the STATus:QUESTionable register. Readout does not delete the contents of the CONDition section.

**Example:** "STAT:QUES:COND?"

**Characteristics:** \*RST value: –  
SCPI: conforming

**Mode:** all

**STATus:QUEStionable:ENABle 0 to 65535**

This command sets the bits of the ENABle section of the STATus-QUEStionable register. The ENABle register selectively enables the individual events of the associated EVENT section for the summary bit in the status byte.

**Example:** "STAT:QUES:ENAB 65535"

**Characteristics:** \*RST value: –  
SCPI: conforming

**Mode:** all

**STATus:QUEStionable:PTRansition 0 to 65535**

This command sets the edge detectors of all bits of the STATus:QUEStionable register from 0 to 1 for the transitions of the CONDition bit.

**Example:** "STAT:QUES:PTR 65535"

**Characteristics:** \*RST value: –  
SCPI: conforming

**Mode:** all

**STATus:QUEStionable:NTRansition 0 to 65535**

This command sets the edge detectors of all bits of the STATus:OPERation register from 1 to 0 for the transitions of the CONDition bit.

**Example:** "STAT:QUES:NTR 65535"

**Characteristics:** \*RST value: –  
SCPI: conforming

**Mode:** all

**STATus:QUEStionable:POWer[:EVENT]?**

This command queries the contents of the EVENT section of the STATus:QUEStionable:POWer register. Readout deletes the contents of the EVENT section.

**Example:** "STAT:QUES?"

**Characteristics:** \*RST value: –  
SCPI: conforming

**Mode:** all

**STATus:QUEStionable:POWer:CONDition?**

This command queries the contents of the CONDition section of the STATus:QUEStionable:POWer register. Readout does not delete the contents of the CONDition section.

**Example:** "STAT:QUES:COND?"

**Characteristics:** \*RST value: –  
SCPI: conforming

**Mode:** all

**STATus:QUEStionable:POWer:ENABle** 0 to 65535

This command sets the bits of the ENABle section of the STATus:QUEStionable:POWer register. The ENABle register selectively enables the individual events of the associated EVENt section for the summary bit.

**Example:** "STAT:QUES:ENAB 65535"

**Characteristics:** \*RST value: –  
SCPI: conforming

**Mode:** all

**STATus:QUEStionable:POWer:PTRansition** 0 to 65535

This command sets the edge detectors of all bits of the STATus:QUEStionable:POWer register from 0 to 1 for the transitions of the CONDition bit.

**Example:** "STAT:QUES:PTR 65535"

**Characteristics:** \*RST value: –  
SCPI: conforming

**Mode:** all

**STATus:QUEStionable:POWer:NTRansition** 0 to 65535

This command sets the edge detectors of all bits of the STATus:QUEStionable:POWer register from 1 to 0 for the transitions of the CONDition bit.

**Example:** "STAT:QUES:NTR 65535"

**Characteristics:** \*RST value: –  
SCPI: conforming

**Mode:** all

**STATus:QUEStionable:LIMit<1|2> [:EVENt]?**

This command queries the contents of the EVENt section of the STATus:QUEStionable:LIMit register. Readout deletes the contents of the EVENt section.

**Example:** "STAT:QUES?"

**Characteristics:** \*RST value: –  
SCPI: device-specific

**Mode:** all

**STATus:QUEStionable:LIMit<1|2>:CONDition?**

This command queries the contents of the CONDition section of the STATus:QUEStionable:LIMit register.

Readout does not delete the contents of the CONDition section.

**Example:** "STAT:QUES:LIM:COND?"

**Characteristics:** \*RST value: –  
SCPI: device-specific

**Mode:** all

**STATus:QUEStionable:LIMit<1|2>:ENABle 0 to 65535**

This command sets the bits of the ENABle section of the STATus:QUEStionable register. The ENABle register selectively enables the individual events of the associated EVENT section for the summary bit.

**Example:** "STAT:QUES:ENAB 65535"

**Characteristics:** \*RST value: –  
SCPI: device-specific

**Mode:** all

**STATus:QUEStionable:LIMit<1|2>:PTRansition 0 to 65535**

This command sets the edge detectors of all bits of the STATus:QUEStionable:LIMit register from 0 to 1 for the transitions of the CONDition bit.

**Example:** "STAT:QUES:PTR 65535"

**Characteristics:** \*RST value: –  
SCPI: device-specific

**Mode:** all

**STATus:QUEStionable:LIMit<1|2>:NTRansition 0 to 65535**

This command sets the edge detectors of all bits of the STATus:QUEStionable:LIMit register from 1 to 0 for the transitions of the CONDition bit.

**Example:** "STAT:QUES:NTR 65535"

**Characteristics:** \*RST value: –  
SCPI: device-specific

**Mode:** all

**STATus:QUEStionable:LMARgin<1|2>[:EVENT]?**

This command queries the contents of the EVENT section of the STATus:QUEStionable:LMARgin register. Readout deletes the contents of the EVENT section.

**Example:** "STAT:QUES:LMAR?"

**Characteristics:** \*RST value: –  
SCPI: device-specific

**Mode:** all

**STATus:QUEStionable:LMARgin<1|2>:CONDition?**

This command queries the contents of the CONDition section of the STATus:QUEStionable:LMARgin register. Readout does not delete the contents of the CONDition section.

**Example:** "STAT:QUES:LMAR:COND?"

**Characteristics:** \*RST value: –  
SCPI: device-specific

**Mode:** all

**STATus:QUEStionable:LMARgin<1|2>:ENABle** 0 to 65535

This command sets the bits of the ENABle section of the STATus:QUEStionable:LMARgin register. The ENABle register selectively enables the individual events of the associated EVENt section for the summary bit.

**Example:** "STAT:QUES:LMAR:ENAB 65535"

**Characteristics:** \*RST value: –  
SCPI: device-specific

**Mode:** all

**STATus:QUEStionable:LMARgin<1|2>:PTRansition** 0 to 65535

This command sets the edge detectors of all bits of the STATus:QUEStionable:LMARgin register from 0 to 1 for the transitions of the CONDition bit.

**Example:** "STAT:QUES:LMAR:PTR 65535"

**Characteristics:** \*RST value: –  
SCPI: device-specific

**Mode:** all

**STATus:QUEStionable:LMARgin<1|2>:NTRansition** 0 to 65535

This command sets the edge detectors of all bits of the STATus:QUEStionable:LMARgin register from 1 to 0 for the transitions of the CONDition bit.

**Example:** "STAT:QUES:LMAR:NTR 65535"

**Characteristics:** \*RST value: –  
SCPI: device-specific

**Mode:** all

**STATus:QUEStionable:SYNC[:EVENt]?**

This command queries the contents of the EVENt section of the STATus:QUEStionable:SYNC register. Readout deletes the contents of the EVENt section.

**Example:** "STAT:QUES?"

**Features:** \*RST value: –  
SCPI: device-specific

**Modes:** all

**STATus:QUEStionable:SYNC:CONDition?**

This command queries the contents of the CONDition section of the STATus:QUEStionable:SYNC register. Readout does not delete the contents of the CONDition section.

**Example:** "STAT:QUES:COND?"

**Features:** \*RST value: –  
SCPI: device-specific

**Modes:** all

**STATus:QUEStionable:SYNC:ENABle 0 to 65535**

This command sets the bits of the ENABle section of the STATus:QUEStionable: SYNC register. The ENABle register selectively enables the individual events of the associated EVENt section for the sum bit in the status byte.

**Example:** "STAT:QUES:ENAB 65535"  
**Features:** \*RST value: –  
 SCPI: device-specific  
**Modes:** all

**STATus:QUEStionable:SYNC:PTRansition 0 to 65535**

This command sets the edge detectors of all bits of the STATus:QUEStionable: SYNC register from 0 to 1 for the transitions of the CONDition bit.

**Example:** "STAT:QUES:PTR 65535"  
**Features:** \*RST value: –  
 SCPI: device-specific  
**Modes:** all

**STATus:QUEStionable:SYNC:NTRansition 0 to 65535**

This command sets the edge detectors of all bits of the STATus:QUEStionable: SYNC register from 1 to 0 for the transitions of the CONDition bit.

**Example:** "STAT:QUES:NTR 65535"  
**Features:** \*RST value: –  
 SCPI: device-specific  
**Modes:** all

**STATus:QUEStionable:ACPLimit[:EVENT]?**

This command queries the contents of the EVENt section of the STATus:QUEStionable:ACPLimit register. Readout deletes the contents of the EVENt section.

**Example:** "STAT:QUES:ACPL?"  
**Characteristics:** \*RST value: –  
 SCPI: device-specific  
**Mode:** all

**STATus:QUEStionable:ACPLimit:CONDition?**

This command queries the contents of the CONDition section of the STATus:QUEStionable:ACPLimit register. Readout does not delete the contents of the CONDition section.

**Example:** "STAT:QUES:ACPL:COND?"  
**Characteristics:** \*RST value: –  
 SCPI: device-specific  
**Mode:** all

**STATus:QUESTionable:ACPLimit:ENABLE** 0 to 65535

This command sets the bits of the ENABLE section of the STATus:QUESTionable:ACPLimit register. The ENABLE register selectively enables the individual events of the associated EVENT section for the summary bit.

**Example:** "STAT:QUES:ACPL:ENAB 65535"

**Characteristics:** \*RST value: –  
SCPI: device-specific

**Mode:** all

**STATus:QUESTionable:ACPLimit:PTRansition** 0 to 65535

This command sets the edge detectors of all bits of the STATus:QUESTionable: ACPLimit register from 0 to 1 for the transitions of the CONDition bit.

**Example:** "STAT:QUES:ACPL:PTR 65535"

**Characteristics:** \*RST value: –  
SCPI: device-specific

**Mode:** all

**STATus:QUESTionable:ACPLimit:NTRansition** 0 to 65535

This command sets the edge detectors of all bits of the STATus:QUESTionable: ACPLimit register from 1 to 0 for the transitions of the CONDition bit.

**Example:** "STAT:QUES:ACPL:NTR 65535"

**Characteristics:** \*RST value: –  
SCPI: device-specific

**Mode:** all

**STATus:QUESTionable:FREQuency[:EVENT]?**

This command queries the contents of the EVENT section of the STATus:QUESTionable: FREQuency register.

**Example:** "STAT:QUES:FREQ?"

**Characteristics:** \*RST value: –  
SCPI: device-specific

**Mode:** all

Readout deletes the contents of the EVENT section.

**STATus:QUESTionable:FREQuency:CONDition?**

This command queries the contents of the CONDition section of the STATus:QUESTionable:FREQuency register. Readout does not delete the contents of the CONDition section.

**Example:** "STAT:QUES:FREQ:COND?"

**Characteristics:** \*RST value: –  
SCPI: device-specific

**Mode:** all



**STATus:QUEStionable:FREQuency:ENABle 0 to 65535**

This command sets the bits of the ENABle section of the STATus:QUEStionable:FREQuency register. The ENABle register selectively enables the individual events of the associated EVENT section for the summary bit.

**Example:** "STAT:QUES:FREQ:ENAB 65535"

**Characteristics:** \*RST value: –  
SCPI: device-specific

**Mode:** all

**STATus:QUEStionable:FREQuency:PTRansition 0 to 65535**

This command sets the edge detectors of all bits of the STATus:QUEStionable:FREQuency register from 0 to 1 for the transitions of the CONDition bit.

**Example:** "STAT:QUES:FREQ:PTR 65535"

**Characteristics:** \*RST value: –  
SCPI: device-specific

**Mode:** all

**STATus:QUEStionable:FREQuency:NTRansition 0 to 65535**

This command sets the edge detectors of all bits of the STATus:QUEStionable:FREQuency register from 1 to 0 for the transitions of the CONDition bit.

**Example:** "STAT:QUES:FREQ:NTR 65535"

**Characteristics:** \*RST value: –  
SCPI: device-specific

**Mode:** all

**STATus:QUEStionable:TRANsducer[:EVENT]?**

This command queries the contents of the EVENT section of the STATus:QUEStionable:TRANsducer register. Readout deletes the contents of the EVENT section.

**Example:** "STAT:QUES:TRAN?"

**Features:** \*RST value: –  
SCPI: device-specific

**Modes:** all

**STATus:QUEStionable:TRANsducer:CONDition?**

This command queries the contents of the CONDition section of the STATus:QUEStionable:FREQuency register. Readout does not delete the contents of the CONDition section.

**Example:** "STAT:QUES:TRAN:COND?"

**Features:** \*RST value: –  
SCPI: device-specific

**Modes:** all

**STATus:QUEStionable:TRANsducer:ENABle** 0 to 65535

This command sets the bits of the ENABle section of the STATus:QUEStionable:TRANsducer register. The ENABle register selectively enables the individual events of the associated EVENT section for the sum bit in the status byte.

**Example:** "STAT:QUES:TRAN:ENAB 65535"

**Features:** \*RST value: –  
SCPI: device-specific

**Modes:** all

**STATus:QUEStionable:TRANsducer:PTRansition** 0 to 65535

This command sets the edge detectors of all bits of the STATus:QUEStionable:TRANsducer register from 0 to 1 for the transitions of the CONDition bit.

**Example:** "STAT:QUES:TRAN:PTR 65535"

**Features:** \*RST value: –  
SCPI: device-specific

**Modes:** all

**STATus:QUEStionable:TRANsducer:NTRansition** 0 to 65535

This command sets the edge detectors of all bits of the STATus:QUEStionable:TRANsducer register from 1 to 0 for the transitions of the CONDition bit.

**Example:** "STAT:QUES:TRAN:NTR 65535"

**Features:** \*RST value: –  
SCPI: device-specific

**Modes:** all

**STATus:QUEue[:NEXT]?**

This command returns the earliest entry to the error queue and deletes it.

Positive error numbers indicate device-specific errors, negative error numbers are error messages defined by SCPI (cf. Chapter 9). If the error queue is empty, the error number 0, "no error", is returned. This command is identical with the command SYSTem:ERRor.

**Example:** "STAT:QUE?"

**Characteristics:** \*RST value: –  
SCPI: conforming

**Mode:** all

# SYSTEM Subsystem

This subsystem contains a series of commands for general functions.

COMMAND	PARAMETERS	UNIT	COMMENT
SYSTEM			
:COMMunicate			
:GPIB			
[:SELF]			
:ADDRESS	0 to 30	--	
:RTERminator	LFEoi   EOI		
:RDEvice			
:GENerator<1 2>			ext. generator option
:ADDRESS	0 to 30		ext. generator option
:RDEvice			
:GENerator<1 2>			tracking generator option
:LINK	GPIB   TTL		tracking generator option
:TYPE	<name>		tracking generator option
:SERial			
:CONTRol			
:DTR	IBFull   OFF		
:RTS	IBFull   OFF		
[:RECeive]			
:BAUD	<numeric_value>	--	
:BITS	7   8	--	
:PARity			
[:TYPE]	EVEN   ODD   NONE		
:SBITs	1   2	--	
:PACE	XON   NONE		
:PRINter			
:ENUMerate			
[:NEXT?]			query only
:FIRSt?			query only
:SELeCt<1 2>	<printer_name>		
:DATE	<num>, <num>, <num>	--	
:DISPlay			
:FPANel	<Boolean>		
:UPDate	<Boolean>		
:ERRor?	--	--	query only
:FIRMware			
:UPDate	<string>		no query
:PASSword			
[:CENable]	<string>		no query
:PRESet	--	--	no query
:SET	<block>		
:SPEaker			audio demodulator option
:VOLume	<numeric_value>	--	
:TIME	0 to 23, 0 to 59, 0 to 59	--	
:VERSion?	--	--	query only

**SYSTEM:COMMunicate:GPIB[:SELF]:ADDRESS** 0 to 30

This command changes the IEC/IEEE-bus address of the unit.

**Example:** "SYST:COMM:GPIB:ADDR 18"

**Characteristics:** \*RST value: - (no influence on this parameter, factory default 20)  
SCPI: conforming

**Mode:** all

**SYSTEM:COMMunicate:GPIB[:SELF]:RTERminator** LFEOI | EOI

This command changes the GPIB receive terminator.

According to the standard the terminator in ASCII is <LF> and/or <EOI>. For binary data transfers (eg trace data) from the control computer to the instrument, the binary code (0AH) used for <LF> might be included in the binary data block, and therefore should not be interpreted as a terminator in this particular case. This can be avoided by changing the receive terminator to EOI.

Output of binary data from the instrument to the control computer does not require such a terminator change.

**Example:** "SYST:COMM:GPIB:RTER EOI"

**Characteristics:** \*RST value: -- (no influence on this parameter, factory default LFEOI)  
SCPI: device-specific

**Mode:** all

**SYSTEM:COMMunicate:GPIB:RDEvice:GENerator<1|2>:ADDRESS** 0 to 30

This command changes the IEC/IEEE-bus address of the device selected as external generator 1 or 2.

**Note:** *If two generators are connected at the same time to IECBUS 2 their addresses must be different.*

*The command is only available with option Ext. Generator Control B10.*

**Example:** "SYST:COMM:GPIB:RDEV:GEN1:ADDR 19" 'Changes the IECBUS address  
'of generator 1 to 19

**Characteristics:** \*RST value: 28  
SCPI: device-specific

**Operating mode:** all



SYSTem:COMMunicate:RDEvice:GENerator<1 | 2>:TYPE <name>

This command selects the type of external generator 1 or 2. The following table shows the available generator types including the associated interface:

Generator	Interface Type	Generator Min Freq	Generator Max Freq	Generator Min Power dBm	Generator Max Power dBm
SME02	TTL	5 kHz	1.5 GHz	-144	+16
SME03	TTL	5 kHz	3.0 GHz	-144	+16
SME06	TTL	5 kHz	6.0 GHz	-144	+16
SMG	GPIB	100 kHz	1.0 GHz	-137	+13
SMGL	GPIB	9 kHz	1.0 GHz	-118	+30
SMGU	GPIB	100 kHz	2.16 GHz	-140	+13
SMH	GPIB	100 kHz	2.0 GHz	-140	+13
SMHU	GPIB	100 kHz	4.32 GHz	-140	+13
SMIQ02B	TTL	300 kHz	2.2 GHz	-144	+13
SMIQ02E	GPIB	300 kHz	2.2 GHz	-144	+13
SMIQ03B	TTL	300 kHz	3.3 GHz	-144	+13
SMIQ03E	GPIB	300 kHz	3.3 GHz	-144	+13
SMIQ04B	TTL	300 kHz	4.4 GHz	-144	+10
SMIQ06B	TTL	300 kHz	6.4 GHz	-144	+10
SML01	GPIB	9 kHz	1.1 GHz	-140	+13
SML02	GPIB	9 kHz	2.2 GHz	-140	+13
SML03	GPIB	9 kHz	3.3 GHz	-140	+13
SMR20	TTL	1 GHz	20 GHz	-130 <sup>2)</sup>	+11 <sup>2)</sup>
SMR20B11 <sup>1)</sup>	TTL	10 MHz	20 GHz	-130 <sup>2)</sup>	+13 <sup>2)</sup>
SMR27	TTL	1 GHz	27 GHz	-130 <sup>2)</sup>	+11 <sup>2)</sup>
SMR27B11 <sup>1)</sup>	TTL	10 MHz	27 GHz	-130 <sup>2)</sup>	+12 <sup>2)</sup>
SMR30	TTL	1 GHz	30 GHz	-130 <sup>2)</sup>	+11 <sup>2)</sup>
SMR30B11 <sup>1)</sup>	TTL	10 MHz	30 GHz	-130 <sup>2)</sup>	+12 <sup>2)</sup>
SMR40	TTL	1 GHz	40 GHz	-130 <sup>2)</sup>	+9 <sup>2)</sup>
SMR40B11 <sup>1)</sup>	TTL	10 MHz	40 GHz	-130 <sup>2)</sup>	+12 <sup>2)</sup>
SMR20	GPIB	1 GHz	20 GHz	-130 <sup>2)</sup>	+11 <sup>2)</sup>
SMR20B11 <sup>1)</sup>	GPIB	10 MHz	20 GHz	-130 <sup>2)</sup>	+13 <sup>2)</sup>
SMR27	GPIB	1 GHz	27 GHz	-130 <sup>2)</sup>	+11 <sup>2)</sup>
SMR27B11 <sup>1)</sup>	GPIB	10 MHz	27 GHz	-130 <sup>2)</sup>	+12 <sup>2)</sup>
SMR30	GPIB	1 GHz	30 GHz	-130 <sup>2)</sup>	+11 <sup>2)</sup>
SMR30B11 <sup>1)</sup>	GPIB	10 MHz	30 GHz	-130 <sup>2)</sup>	+12 <sup>2)</sup>
SMR40	GPIB	1 GHz	40 GHz	-130 <sup>2)</sup>	+9 <sup>2)</sup>
SMR40B11 <sup>1)</sup>	GPIB	10 MHz	40 GHz	-130 <sup>2)</sup>	+12 <sup>2)</sup>
SMP02	TTL	10 MHz	20 GHz	-130 <sup>3)</sup>	+17 <sup>3)</sup>
SMP03	TTL	10 MHz	27 GHz	-130 <sup>3)</sup>	+13 <sup>3)</sup>
SMP04	TTL	10 MHz	40 GHz	-130 <sup>3)</sup>	+12 <sup>3)</sup>
SMP22	TTL	10 MHz	20 GHz	-130 <sup>3)</sup>	+20 <sup>3)</sup>
SMT02	GPIB	5.0 kHz	1.5 GHz	-144	+13
SMT03	GPIB	5.0 kHz	3.0 GHz	-144	+13
SMT06	GPIB	5.0 kHz	6.0 GHz	-144	+13

<sup>1)</sup> Requires mounting of option SMR-B11.

<sup>2)</sup> Maximum/Minimum Power depends on the presence of option SMR-B15/-B17 and of the selected frequency range. For details please consult the SMR datasheet.

<sup>3)</sup> Maximum/Minimum Power depends on the presence of option SMP-B15/-B17 and of the selected frequency range. For details please consult the SMP datasheet.

Generator	Interface Type	Generator Min Freq	Generator Max Freq	Generator Min Power dBm	Generator Max Power dBm
SMX	GPIB	100 kHz	1.0 GHz	-137	+13
SMY01	GPIB	9 kHz	1.04 GHz	-140	+13
SMY02	GPIB	9 kHz	2.08 GHz	-140	+13
HP8340A	GPIB	10 MHz	26.5 GHz	-110	10
HP ESG-A Series 1000A, 2000A, 3000A, 4000A	GPIB	250 kHz	4 GHz	-136	20
HP ESG-D SERIES E4432B	GPIB	250 kHz	3 GHz	-136	+10

**Notes:** Generators with TTL interface can also be operated via IECBUS (= GPIB) alone.

With NONE selected, the corresponding generator 1 or 2 is deactivated.

The command is only available with option Ext. Generator Control B10.

**Example:** "SYST:COMM:RDEV:GEN2:TYPE 'SME02'" 'Selects SME02 as generator 2.

**Characteristics:** \*RST value: NONE  
 SCPI: device-specific

**SYSTEM:COMMunicate:SERial:CONTrol:DTR** IBFull | OFF  
**SYSTEM:COMMunicate:SERial:CONTrol:RTS** IBFull | OFF

These commands switch the hardware handshake procedure for the serial interface off (OFF) or on (IBFull).

The two commands are equivalent.

**Examples:** "SYST:COMM:SER:CONT:DTR OFF"  
 "SYST:COMM:SER:CONT:RTS IBF"

**Characteristics:** \*RST value: -- (no influence on this parameter, factory default OFF)  
 SCPI: conforming

**Mode:** all

**SYSTEM:COMMunicate:SERial[:RECEive]:BAUD** 110 | 300 | 600 | 1200 | 2400 | 9600 | 19200

This command sets the transmission speed for the serial interface (COM).

**Example:** "SYST:COMM:SER:BAUD 2400"

**Characteristics:** \*RST value: -- (no influence on this parameter, factory default 9600)  
 SCPI: conforming

**Mode:** all

**SYSTEM:COMMunicate:SERial[:RECeive]:BITS 7 | 8**

This command defines the number of data bits per data word for the serial interface (COM).

**Example:** "SYST:COMM:SER:BITS 7"

**Characteristics:** \*RST value: -- (no influence on this parameter, factory default 8)  
SCPI: conforming

**Mode:** all

**SYSTEM:COMMunicate:SERial[:RECeive]:PARity[:TYPE] EVEN | ODD | NONE**

This command defines the parity check for the serial interface (COM).

Possible values are:           EVEN even parity  
                                  ODD odd parity  
                                  NONE no parity check.

**Example:** "SYST:COMM:SER:PAR EVEN"

**Characteristics:** \*RST value: -- (no influence on this parameter, factory default NONE)  
SCPI: conforming

**Mode:** all

**SYSTEM:COMMunicate:SERial[:RECeive]:SBITS 1|2**

This command defines the number of stop bits per data word for the serial interface (COM).

**Example:** "SYST:COMM:SER:SBITS 2"

**Characteristics:** \*RST value: -- (no influence on this parameter, factory default 1)  
SCPI: conforming

**Mode:** all

**SYSTEM:COMMunicate:SERial[:RECeive]:PACE XON | NONE**

This command switches on or off the software handshake for the serial interface.

**Example:** "SYST:COMM:SER:PACE XON"

**Characteristics:** \*RST value: -- (no influence on this parameter, factory default NONE)  
SCPI: conforming

**Mode:** all



**SYSTEM:COMMunicate:PRINter:ENUMerate:FIRSt?**

This command queries the name of the first printer (in the list of printers) available under Windows NT.

The names of other installed printers can be queried with command SYSTEM:COMMunicate:PRINter:ENUMerate:NEXT?.

If no printer is configured an empty string is output.

**Example:** "SYST:COMM:PRIN:ENUM:FIRS?"

**Characteristics:** \*RST value: NONE  
SCPI: device-specific

**Mode:** all

**SYSTEM:COMMunicate:PRINter:ENUMerate:NEXT?**

This command queries the name of the next printer installed under Windows NT.

The command

SYSTEM:COMMunicate:PRINter:ENUMerate:FIRSt?

should be sent previously to return to the beginning of the printer list and query the name of the first printer.

The names of other printers can then be queried with NEXT?. After all available printer names have been output, an empty string enclosed by quotation marks (") is output for the next query. Further queries are answered by a Query Error.

**Example:** "SYST:COMM:PRIN:ENUM:NEXT?"

**Characteristics:** \*RST value: NONE  
SCPI: device-specific

**Mode:** all

**SYSTEM:COMMunicate:PRINter:SELEct <1|2> <printer\_name>**

This command selects one of the printers configured under Windows NT including the associated output destination.

The specified printer name must be a string as returned by the commands

SYSTEM:COMMunicate :PRINter:ENUMerate:FIRSt? or

SYSTEM:COMMunicate :PRINter:ENUMerate:NEXT?

**Note:** Command *HCOpy:DESTination* is used to select an output medium other than the default one.

**Example:** "SYST:COMM:PRIN:SEL 'LASER on LPT1'"

**Characteristics:** \*RST value: NONE  
SCPI: device-specific

**Mode:** all

**SYSTem:DATE** 1980 to 2099, 1 to 12, 1 to 31

This command is used to enter the date for the internal calendar.

The sequence of entry is year, month, day.

**Example:** " SYST:DATE 2000,6,1 "

**Characteristics:** \*RST value: –  
SCPI: conforming

**Mode:** all

**SYSTem:DISPlay:FPANel** ON | OFF

This command activates or deactivates the display of the front panel keys on the screen.

With the display activated, the instrument can be operated on the screen using the mouse by pressing the corresponding buttons. This may be useful if the instrument is operated in a detached station by means of a remote program such as PCANYWHERE.

**Notes:** *With the display of the front panel keys activated, the screen resolution of the unit is set to 1024x768. Thus, only a section of the whole screen is visible on the internal LCD display, which will be moved by mouse moves.*

*For a full display of the user interface, an external monitor has to be connected to the rear panel.*

*When the front panel display is deactivated, the original screen resolution is restored.*

**Example:** " SYST:DISP:FPAN ON "

**Characteristics:** \*RST value: OFF  
SCPI: device-specific

**Operating mode:** all

**SYSTem:DISPlay:UPDate** ON | OFF

This command switches on or off the update of all display elements during remote control.

**Note:** *The best performance is obtained when the display output is switched off during remote control.*

**Example:** " SYST:DISP:UPD ON "

**Characteristics:** \*RST value: OFF  
SCPI: device specific

**Mode:** all

**SYSTem:ERRor?**

This command queries the earliest entry in the error queue, and deletes it after the readout.

Positive error numbers indicate device-specific errors, negative error numbers are error messages defined by SCPI (cf. Chapter 9). If the error queue is empty, the error number 0, "no error", is returned. This command is identical with the command `STATus:QUEue:NEXT?`. This command is a query and is therefore not assigned an \*RST value.

**Example:** " SYST:ERR? "

**Characteristics:** \*RST value: –  
SCPI: conforming

**Mode:** all

**SYSTEM:ERRor:LIST?**

This command reads all system messages and returns a list of comma separated strings. Each string corresponds to an entry in the table SYSTEM MESSAGES.

If the error list is empty, an empty string "" will be returned.

This command is a query and is therefore not assigned an \*RST value.

**Example:** "SYST:ERR:LIST?"

**Characteristics:** \*RST value: –  
SCPI: device specific

**Mode:** all

**SYSTEM:ERRor:CLEar:ALL**

This command deletes all entries in the table SYSTEM MESSAGES.

This command is an event and is therefore not assigned a query or an \*RST value.

**Example:** "SYST:ERR:CLE:ALL?"

**Characteristics:** \*RST value: –  
SCPI: device specific

**Mode:** all

**SYSTEM:FIRMware:UPDate <path>**

This command starts a firmware update using the data set in the selected directory. Beforehand, the update files have to be stored in the following subdirectories using command MMEM:DATA:

Directory	Contents				
DISK1	_inst32i.ex_	_isdel.exe	_setup.dll	_sys1.cab	_user1.cab
	data.tag	data1.cab	id.txt	lang.dat	layout.bin
	os.dat	Setup.exe	Setup.ini	setup.ins	setup.lid
DISK2	data2.cab				
DISK3	data3.cab				
DISK4	data4.cab				
DISK5	data5.cab				

**Example:** "SYST:FIRM:UPD 'D:\USER\FWUPDATE' "  
'Starts the firmware update  
'from directory  
'D:\USER\FWUPDATE using the '  
'files of ubdirectories DISK1  
'to DISK5

**Characteristics:** \*RST value: –  
SCPI: device specific

**Mode:** all

This command is an 'event' and has therefore no query form and is not assigned an \*RST value.

**SYSTEM:PASSword[:CENable]** <string>

This command enables access to the service functions by means of the password.

**Example:** "SYST:PASS 'XXXXX'"

**Characteristics:** \*RST value: –  
SCPI: conforming

**Mode:** all

This command is an event and is therefore not assigned an \*RST value and has no query.

**SYSTEM:PRESet**

This command initiates an instrument reset.

The effect of this command corresponds to that of the *PRESET* key with manual control or to the \*RST command.

**Example:** "SYST:PRES"

**Characteristics:** \*RST value: –  
SCPI: conforming

**Mode:** all

**SYSTEM:SET** <block>

The query `SYSTEM:SET?` causes the data of the current instrument setting to be transmitted to the control computer in binary format (SAVE function). The data can be read back into the instrument (RECALL function) by means of command `SYSTEM:SET <block>`. Whilst the data records are stored on the instrument harddisk with `SAVE/RECALL (MMEMory:STORE bzw. MMEMory:LOAD)`, it is possible to store the data in an external computer by means of `SYSTEM:SET`.

The receive terminator has to be set to EOI to ensure reliable transfer of data (setting `SYST:COMM:GPIB:RTER EOI`).

**Example:** "SYST:SET "

**Characteristics:** \*RST value: –  
SCPI: conforming

**Mode:** all

**SYSTEM:SPEaker:VOLume** 0 to 1

This command sets the volume of the built-in loudspeaker for demodulated signals. Minimum volume is set by 0 and maximum volume by 1.

The value 0 is the lowest volume, the value 1 the highest volume.

**Example:** "SYST:SPE:VOL 0.5"

**Characteristics:** \*RST value: 0  
SCPI: device-specific

**Mode:** all

**SYSTEM:TIME** 0 to 23, 0 to 59, 0 to 59

This command sets the internal clock. The sequence of entry is hour, minute, second.

**Example:** "SYST:TIME 12,30,30"

**Characteristics:** \*RST value: –  
SCPI: conforming

**Mode:** all

**SYSTEM:VERSion?**

This command queries the number of the SCPI version, which is relevant for the instrument.

**Example:** "SYST:VERS?"

**Characteristics:** \*RST value: –  
SCPI: conforming

**Mode:** all

This command is a query and is therefore not assigned an \*RST value.

# TRACe Subsystem

The TRACe subsystem controls access to the instrument's internal trace memory.

COMMAND	PARAMETERS	UNIT	COMMENT
TRACe<1 2> [:DATA]	TRACE1  TRACE2  TRACE3  TRACE4  SINGLE  SCAN  STATus  FINAL1   FINAL2   FINAL3, @<block> <numeric_value>...	-	
:COPY	TRACE1 TRACE2 TRACE3, TRACE1 TRACE2 TRACE3		
:IQ			
:AVERage [:STATe]	<Boolean> <numeric_value>	--	
:COUNT			
:DATA?	<numeric_value>, <numeric_value>	--, --	query only
:MEMory?	NORMal, <numeric_value>, <numeric_value>, IMMEDIATE   EXTERNAL, IFPower   RFPower, POSitive, <numeric_value>, <numeric_value>	--, HZ, HZ, --, --, --, --	query only
:SET			
:SRATe [:STATe]	<numeric_value> <Boolean>	HZ	
:ONLine [:STATe]	<Boolean>		
:SFACtor :I? :Q?			query only query only

## General Trace Commands

### TRACe[:DATA]

TRACE1| TRACE2| TRACE3| SINGLE | SCAN| STATus | FINAL1 | FINAL1 | FINAL2 | FINAL3,  
<block> | <numeric\_value>

This command transfers trace data from the control computer to the instrument, the query reads trace data out of the instrument. The associated measurement window is selected with the numeric suffix of TRACe<1|2>.

**Example:** "TRAC TRACE1, "+A\$ (A\$: data list in the current format)  
"TRAC? TRACE1"

**Characteristics:** \*RST value: -  
SCPI: conforming

**Mode:** all

#### Return values:

The returned values are scaled in the current level unit.

FORMat ASCII

In ASCII format, a list of values separated by commas is returned (Comma Separated Values = CSV). The number of measurement points is 501.

FORMat REAL, 32

If the transmission takes place using the binary format (REAL,32), the data are transferred in block format (Definite Length Block Data according to IEEE 488.2). They are arranged in succeeding lists of I and Q data of 32 Bit IEEE 754 floating point numbers. General structure of return string:

```
#42004<meas value 1><meas value value2>...<meas value 501>
```

with

```
#4           digits of the subsequent number of data bytes (4 in the example)
2004        Number of the subsequent data bytes (2004 in the example)
<meas value x> 4 byte floating point measurement values
```

### Saving and recalling:

Saving and recalling trace data together with the device settings to/from the device-internal hard disk or to/from a floppy is controlled via the commands "MMEMory:STORE:STATE" and

"MMEMory:LOAD:STATE" respectively. Trace data are selected with

"MMEMory:SELEct[:ITEM]:ALL" or "MMEMory:SELEct[:ITEM]:TRACe". Trace data in ASCII format (ASCII FILE EXPORT) are exported with the command "MMEMory:STORE:TRACe".

The commands for the final measurement data are "MMEMory:SELEct[:ITEM]:FINAl" and "MMEMory:STORE:FINAl".

### Transfer format:

The trace data are transferred in the current format (corresponding to the command FORMat ASCii|REAL). The device-internal trace memory is addressed using the trace names 'TRACE1' to 'FINAL3'.

The transfer of trace data from the control computer to the instrument takes place by indicating the trace name and then the data to be transferred. In ASCII format, these data are values separated by commas. If the transfer takes place using the format real (REAL,32), the data are transferred in block format.

The parameter of the query is the trace name TRACE1 to FINAL3, it indicates which trace memory will be read out.

The transfer format for the trace data depends on the instrument setting:

### SPECTRUM mode (span > 0 and zero span):

501 results are output in the unit selected for display.

**Note:** *With AUTO PEAK detector, only positive peak values can be read out. Trace data can be written into the instrument with logarithmic display only in dBm, with linear display only in volts.*

FORMAT REAL,32 is to be used as format for binary transmission.

### Receiver

**Note:** *For reasons of compatibility with the ESIB test receiver, the data structure of the status information is designed for 4 traces. However, only 3 traces can be activated and transferred.*

SINGLE is possible only as a query for single measurements in the receiver mode. The values of all activated detectors are transferred separated by commas in the following order: POS, NEG, QPE, AVER, RMS. For inactive detectors, the value and the comma are omitted at the position(s) in question.

SCAN is only possible in form of a query during scan measurements. The number of transmitted measurement results depends on the scan settings.

FORMAT REAL,32 is to be used as format setting for binary transmission.

Structure of transmitted data:

- 4 byte: trace status: bit 0 to 9 subscan; bit 10: last block of subscan; Bit 11: last block of last subscan of scan; Bit 12: last of all blocks (for multiple scans after the last scan)
- 4 bytes: number n of the transmitted measurement results of a trace
- 4 byte: trace1 active (0/1)
- 4 byte: trace2 active (0/1)
- 4 byte: trace3 active (0/1)
- n\*4 bytes: measurement results of trace 1 if trace 1 is active
- n\*4 bytes: measurement results of trace 2 if trace 2 is active
- n\*4 bytes: measurement results of trace 3 if trace 3 is active
- n\*4 bytes: reserved
- n\*1 byte: status information per measurement result:  
bit 0: underrange trace1; bit 1: underrange trace2; bit 2: underrange trace3;  
bit 3: overrange trace1 to trace4

STATUS is only possible in form of a query during scan measurements. 1 byte status information per measurement result is transmitted:

bit 0: underrange trace1; bit 1: underrange trace2; bit 2: underrange trace3;  
bit 3: overrange trace1 to trace3

FINAL1, FINAL2 and FINAL3 are only possible in form of a query. The final measurement values are transmitted.

#### **TRACe:COPY** TRACe:COPY TRACE1| TRACE2| TRACE3 , TRACE1| TRACE2| TRACE3

This command copies data from one trace to another. The second operand describes the source, the first operand the destination of the data to be copied. The associated measurement window is selected with the numeric suffix of TRACe<1|2>.

**Example:** "TRAC: COPY TRACE1 , TRACE2"

**Characteristics:** \*RST value:  
SCPI: conforming

**Mode:** R, A

This command is an event and therefore has no query and no \*RST value assigned.



## TRACe:IQ-Subsystem

The commands of this subsystem are used for collection and output of measured IQ data. A special memory is therefore available in the instrument with 128k words for the I and Q data. The measurement is always performed in the time domain (span = 0 Hz) at the selected center frequency. The number of samples to be collected can be set. The sample rate can be set in the range from 15.625 kHz to 32 MHz. Prior to being stored in memory or output via GPIB, the measurement data are corrected in terms of frequency response.

Depending on the sample rate, the following maximum bandwidths can be obtained during the measurement.

Sample rate	Max. bandwidth	Notes
32 MHz	9.6 MHz	
16 MHz	7.72 MHz	
8 MHz	4.8 MHz	Signals outside the given bandwidth are folded back into the useful band due to the anti-aliasing filter.
4 MHz	2.8 MHz	
2 MHz	1.6 MHz	
1 MHz	800 kHz	
500 kHz	400 kHz	
250 kHz	200 kHz	
125 kHz	100 kHz	
62.5 kHz	50 kHz	
31.25 kHz	25 kHz	
15.625 kHz	12.5 kHz	

Due to the sampling concept (21.4 MHz IF, 32 MHz Sampling rate), the image frequency is suppressed only by the 10 MHz analog IF filter. When applying an input signal at the edge of the 10 MHz band (+5 MHz from center), the image frequency appears 800 kHz above the input signal. The image frequency in MHz is calculated as follows:

$$f_{\text{image}} = 2 \cdot (f_{\text{center}} + 5.4 \text{ MHz}) - f_{\text{signal}}$$

where

$f_{\text{image}}$  = image frequency in MHz

$f_{\text{center}}$  = center frequency in MHz

$f_{\text{signal}}$  = frequency of the signal to be measured in MHz

For correct operation the RF input signal shall be limited in bandwidth. Signals more than 5.4 MHz above the center frequency will be mirrored into the  $\pm 5$  MHz pass band.

For additional bandwidth limitation of the measurement data the analog filters (RBW  $\geq$  300 kHz) are available.

The following figure shows the signal processing stages from the analyzer IF to the processor. The IF filter is the resolution filter of the analyzer and can be set between 300 kHz and 10 MHz. The A/D converter samples the IF (20.4 MHz) with a rate of 32 MHz.

After down conversion to the complex base band and subsequent low pass filtering, the sampling rate is reduced. The output sampling rate is set between 15.625 kHz and 32 MHz in  $2^n$  steps. This avoids unnecessary oversampling at smaller bandwidths, reduces the computing time and thus increases the maximum data acquisition time.

The I/Q data are written in a 128 k word memory each. The hardware trigger controls the memories.

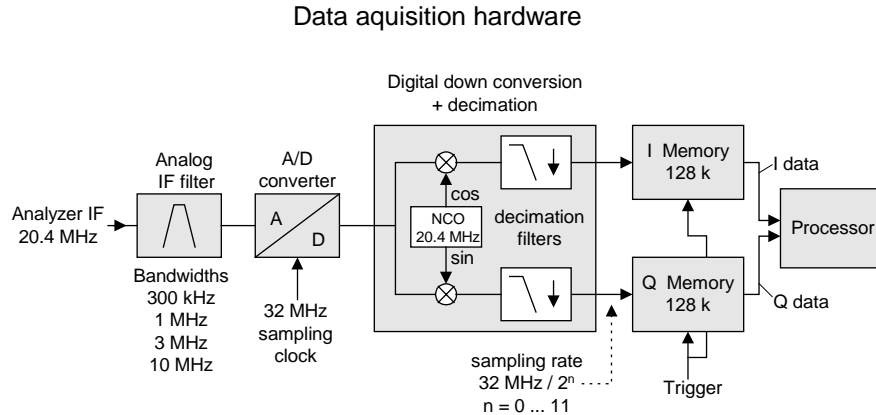

### Block diagram of signal processing

All trigger sources are available except for VIDEO. For all available trigger sources the number of samples to be measured before the trigger point can be selected. Only for FREE RUN this values always has to be set to 0.

The measurement results will be output as a list of values, with the Q-values following immediately after the list of I-values in the output buffer. The FORMAT command can be used to select between binary output (32 Bit IEEE 754 floating point values) and output in ASCII format.

The commands of this subsystem can be used in two ways:

1. Measurement and result query with one command:  
This method causes the least delay between measurement and output of the result data, but it requires the control computer to wait actively for the response data.
2. Setting up the instrument, start of the measurement via "INIT" and query of the result list at the end of the measurement:  
With this method the control computer can be used for other activities during the measurement. In this case the additional time needed for synchronisation via service request must be taken into account.

**TRACe<1|2>:IQ:AVERAge[:STATe] ON|OFF**

The command enables averaging of the recorded I/Q data provided that I/Q data acquisition was previously enabled with `TRAC:IQ ON` and the sampling rate was set to 32 MHz.

**Note:**

*Averaging is not supported at sampling rates <> 32 MHz or for a trigger offset < 0.*

**Example:**

```
TRAC:IQ ON           'Switches on acquisition of I/Q data..
TRAC:IQ:SET NORM,10MHz,32MHz,EXT,POS,0,2048
                                     'Reads 2048 I/Q values starting at
                                     'the time of trigger.
                                     'Filtertyp:      NORMAL (analog)
                                     'RBW:           10 MHz
                                     'Sample Rate:    32 MHz
                                     'Trigger:       external
                                     'Slope:         positive

TRAC:IQ:AVER ON      'Enables averaging of the I/Q measurement data.
TRAC:IQ:AVER:COUN 10 'Selects averaging over 10 data sets..
TRAC:IQ:DATA?        ''Starts the measurement and reads out the averaged
                       'data.
```

**Features:** \*RST value: OFF  
SCPI: device-specific

**Mode:** A-Z

**TRACe<1|2>:IQ:AVERAge:COUNT 0 .. 32767**

This command defines the number of I/Q data sets that are to serve as a basis for averaging.

**Example:**

```
TRAC:IQ ON           'Switches on acquisition of I/Q data.
TRAC:IQ:SET NORM,10MHz,32MHz,EXT,POS,0,2048
                                     'Reads 2048 I/Q values from the
                                     'moment of triggering.
                                     'Filtertyp:      NORMAL (analogue)
                                     'RBW:           10 MHz
                                     'Sample Rate:    32 MHz
                                     'Trigger:       external
                                     'Slope:         positive

TRAC:IQ:AVER ON      'Enables averaging of the I/Q measurement data
TRAC:IQ:AVER:COUN 10 'Selects averaging over 10 data sets
TRAC:IQ:DATA?        ''Starts the measurement and reads out the averaged
                       'data.
```

**Features:** \*RST value: 0  
SCPI: conforming

**Mode:** all

**TRACe<1|2>:IQ:DATA?**

This command starts a measurement with the settings defined via TRACe: IQ: SET and returns the list of measurement results immediately after they are corrected in terms of frequency response. The number of measurement results depends on the settings defined with TRACe: IQ: SET, the output format depends on the settings of the FORMat – subsystem.

**Note:** *The command requires that all response data are read out completely before the instrument accepts further commands.*

**Parameter:** none

**Example:** "TRAC: IQ: STAT ON" 'Enables acquisition of I/Q data  
 "TRAC: IQ: SET NORM, 10MHz, 32MHz, EXT, POS, 0, 4096"  
 'Measurement configuration:  
 'Filtertype: Normal  
 'RBW: 10 MHz  
 'Sample Rate: 32 MHz  
 'Trigger Source: External  
 'Trigger Slope: Positive  
 'Pretrigger Samples: 0  
 '# of Samples: 4096  
 "FORMat REAL, 32" 'Selects format of response data  
 "TRAC: IQ: DATA?" 'Starts measurement and reads results

**Return values:**

The result values are scaled linear in unit *Volt* and correspond to the voltage at the RF input of the instrument.

**ASCII-Format (FORMat ASCII):**

In this case the command returns a comma separated list of the measured voltage values in floating point format (Comma Separated Values = CSV). The number of values returned is 2 \* number of samples, the first half being the I-values, the second half the Q-values.

**Binary-Format (FORMat REAL,32):**

In this case the command returns binary data (Definite Length Block Data according to IEEE 488.2), with the lists of I- and Q-data being arranged one after the other in 32 Bit IEEE 754 floating point data. The scheme of the response string is as follows:

#41024<I-value1><I-value2>...<I-value128><Q-value1><Q-value2>...<Q-value128>

with

- #4 digits of the subsequent number of data bytes (4 in the example)
- 1024 number of subsequent data bytes (# of DataBytes, 1024 in the example)
- <I-value x> 4-Byte-Floating Point I-value
- <Q-value y> 4-Byte-Floating Point Q-value

The number of I- and Q-data can be calculated as follows:

$$\# \text{ of } I - \text{Data} = \# \text{ of } Q - \text{Data} = \frac{\# \text{ of } \text{DataBytes}}{8}$$

The offset of Q-data in the output buffer can be calculated as follows:

$$Q - \text{Data} - \text{Offset} = \frac{(\# \text{ of DataBytes})}{2} + \text{LengthIndicatorDigits}$$

with LengthIndicatorDigits being the number of digits of the length indicator including the '#'. In the example above (#41024...) this results in a value of 6 for LengthIndicatorDigits and the offset for the Q-data will result in  $512 + 6 = 518$ .

**Characteristics:** \*RST-Value: --

**Note:**

Using the command with the \*RST-values for command TRAC:IQ:SET the following minimum buffer sizes for the response data are recommended:

ASCII format: 10 kBytes

Binary format: 2 kBytes

SCPI: device specific

**Mode:** A-T

### TRACe<1|2>:IQ:DATA:MEMory? <offset samples>,<# of samples>

This command permits the readout of previously acquired (and frequency response corrected) I/Q data from the memory, with indication of the offset related to the start of measurement and with indication of the number of measurement values. Therefore a previously acquired data set can be read out in smaller portions. The maximum amount of available data depends on the settings of command TRACe:IQ:SET, the output format on the settings in the FORMat – subsystem.

**Note:** The command requires that all response data are read out completely before the instrument accepts further commands.

If there are not I/Q data available in memory because the corresponding measurement had not been started, the command will cause a Query Error.

**Parameter:** <offset samples> Offset of the values to be read related to the start of the acquired data.  
Value range: 0 to <# of samples> - 1, with <# of samples> being the value indicated with command TRACe:IQ:SET.

<# of samples> Number of measurement values to be read.  
Value range: 1 to <# of samples> - <offset samples> with <# of samples> being the value indicated with command TRACe:IQ:SET.

**Examples:** "TRAC:IQ:STAT ON" 'Enable acquisition of I/Q data

"TRAC:IQ:SET NORM,10MHz,32MHz,EXT,POS,100,4096"

'Configure measurement:

'FilterTyp:Normal

'RBW:10 MHz

'Sample Rate:32 MHz

'Trigger Source:External

'Trigger Slope:Positive

'Pretrigger Samples:100

'# of Samples:4096

"INIT;\*WAI" 'Start measurement and wait for sync

"FORMatREAL,32" 'Determine output format

'Read results:

"TRAC:IQ:DATA:MEM? 0,2048" 'Reads 2048 I/Q data starting at the  
'beginning of data acquisition

"TRAC:IQ:DATA:MEM? 2048,1024" ' Reads 1024 I/Q data from half of the  
'recorded data

"TRAC:IQ:DATA:MEM? 100,512" 'Reads 512 I/Q data starting at the  
'trigger point  
'(<Pretrigger Samples> was 100)

**Return values:**

The result values are scaled linear in unit *Volt* and correspond to the voltage at the RF input of the instrument.

The format of the output buffer corresponds to the command TRACe:IQ:DATA?

**Characteristics:** \*RST-value: --  
SCPI: device specific

**Mode:** A-T

**TRACe<1|2>:IQ:SET** <filter type>,<rbw>,<sample rate>,<trigger source>,<trigger slope>,  
<pretrigger samples>,<# of samples>

This command defines the settings of the analyzer hardware for the measurement of I/Q data. This allows setting the bandwidth of the analog filters in front of the A/D converter as well as setting the sample rate, trigger conditions and the record length.

**Note:** *If this command is omitted, the current analyzer settings will be used for the corresponding parameters.*

**Parameter:**

<filter type>: NORMAL 'Selects the analog analyzer resolution filters as filter type. This is currently the only available filter type.

<rbw>: Bandwidth of the analog filters in front of the A/D converter.

Value range: 300 kHz – 10 MHz in steps of 1, 3, 10 for  
<filter type> = NORMAl

<sample rate>: Sampling rate for the data acquisition.

Value range: 15.625 kHz, 31.25 kHz, 62.5 kHz,  
125 kHz, 250 kHz, 500 kHz,  
1 MHz, 2 MHz, 4 MHz, 8 MHz, 16 MHz,  
32 MHz for <filter type> = NORMAl

<trigger mode>: Selection of the trigger source used for the measurement.

Values: IMMEDIATE | EXTERNAL | IFPOWER | RFPower

**Notes:**

*IFPower and RFPower are available as of model 03 of the detector board assembly.*

*RFPower requires the TV and RF Trigger option FSP-B6.*

*After selecting IFPower and RFPower, the trigger threshold can be set with command TRIG:LEV:IFP or TRIG:LEV:RFP.*

<trigger slope>: Used trigger slope.

Values: POSITIVE (currently the only value supported)

<pretrigger samples>: Number of measurement values to be recorded before the trigger point.

Range: -16744447 (= -(224-1-512k)) to 65023 (= 64\*1024 – 512 - 1)

**Note:** Negative values correspond to a trigger delay.  
For <trigger mode> = IMMEDIATE the value must be 0.

<# of samples>: Number of measurement values to record.  
Value range: 1 to 130560 (= 128\*1024 – 512)  
Value range: 1 to 523776 (= 512\*1024 – 512)

**Examples:**

"TRAC:IQ:SET NORM,10MHz,32MHz,EXT,POS,0,2048" 'Reads 2048 I/Q-values starting at the  
'trigger point.  
'Filtertype: NORMAL (analog)  
'RBW: 10 MHz  
'Sample Rate:32 MHz  
'Trigger: External  
'Slope: Positive

"TRAC:IQ:SET NORM,1MHz,4MHz,EXT,POS,1024,512" 'Reads 512 I/Q-values from 1024  
'measurement points before the  
'trigger point.  
'Filtertype: NORMAL (analog)  
'RBW: 1 MHz  
'Sample Rate:4 MHz  
'Trigger: External  
'Slope: Positive

**Characteristics:** \*RST-values: NORM,3MHz,32MHz,IMM,POS,0,128

**Note:**

For using these default settings with command  
TRAC:IQ:DATA? the following minimum buffer sizes for  
the response data are recommended:  
ASCII format:10 kBytes  
Binary format:2 kBytes

SCPI: device specific

**Mode:** A-T

**TRACe<1|2>:IQ:SRATe** 15.625kHz to 32MHz

This command sets the sampling rate for the I/Q data acquisition. Thus the sample rate can be modified without affecting the other settings.

**Value range:** 15.625 kHz, 31.25 kHz, 62.5 kHz,  
125 kHz, 250 kHz, 500 kHz,  
1 MHz, 2 MHz, 4 MHz, 8 MHz, 16 MHz, 32 MHz

**Example:** "TRAC: IQ: SRAT 4MHZ "

**Characteristics:** \*RST-value: 32 MHz  
SCPI: device specific

**Mode:** A-T

**TRACe<1|2>:IQ[:STATe]** ON | OFF

This command switches the I/Q data acquisition on or off.

**Note:** *The I/Q data acquisition is not compatible with other measurement functions. Therefore all other measurement functions will be switched off as soon as the I/Q measurement function is switched on. Additionally a trace display is not possible in this operating mode. Therefore all traces are set to "BLANK". Finally split screen operation will automatically be stopped.*

**Example:** TRAC: IQ ON 'Switches on I/Q data acquisition

**Characteristics:** \*RST-value: OFF  
SCPI: device specific

**Mode:** A-T



# TRIGger Subsystem

The TRIGger subsystem is used to synchronize instrument actions with events. It is thus possible to control and synchronize the start of a sweep. An external trigger signal can be applied to the connector at the rear panel of the instrument. A distinction is made between TRIGger1 (screen A) and TRIGger2 (screen B).

COMMAND	PARAMETERS	UNIT	COMMENT
TRIGger<1 2> [:SEQuence] :SOURce  :LEVel :IFPower :RFPower :VIDeo :HOLDoff :SLOPe :VIDeo :FORMat :LPFRame :FIEld :SElect :LINE :NUMBer :SSIGnal :POLarity	IMMediate   EXTernal   VIDeo   IFPower   RFPower   TV     525   625  ALL   ODD   EVEN   NEGative   POSitive	  DBM DBM PCT S --	TV, RFPOWer only with Option FSP-B6   Option FSP-B6 TV- und RF-Trigger  Option FSP-B6 TV- und RF-Trigger  Option FSP-B6 TV- und RF-Trigger  Option FSP-B6 TV- und RF-Trigger

**TRIGger<1|2>[:SEQuence]:SOURce** IMMEDIATE | EXTernal | VIDeo | IFPower | RFPower | TV

This command selects the trigger source for the start of a sweep.

**Note:** The selection RFPower or TV is only available with option FSP-B6 (TV- and RF-Trigger).

- Parameter:**
- IMMediate = automatic triggering the next measurement at the end of the previous one. The value IMMEDIATE corresponds to the FREE RUN setting.
  - EXTernal = the next measurement is triggered by the signal at the external trigger input.
  - VIDeo = the next measurement is triggered by the detection of a signal at the video filter output.
  - IFPower = the next measurement is triggered by the detection of a signal at the instrument IF (10 MHz bandwidth)
  - RFPower = the next measurement is triggered by the detection of a signal at the instrument RF (80 MHz bandwidth)
  - TV = the next measurement is triggered by the detection of a TV signal according to the settings of the TRIGger:SEQuence:VIDeo-subsystem.

**Example:** "TRIG:SOUR EXT" 'Selects the external trigger input as source of the trigger signal'

**Characteristics:** \*RST value: IMMEDIATE  
SCPI: conforming

**Mode:** R, A

**TRIGger<1|2>[:SEQuence]:LEVel:VIDeo** 0 to 100PCT

This command sets the level of the video trigger source.

**Example:** "TRIG:LEV:VID 50PCT"

**Characteristics:** \*RST value: 50 PCT  
SCPI: device-specific

**Mode:** all

**TRIGger<1|2>[:SEQuence]:LEVel:IFPower** -30 to -10DBM

This command sets the level of the IF power trigger source.

**Example:** "TRIG:LEV:IFP -20DBM"

**Characteristics:** \*RST value: -20 DBM  
SCPI: device-specific

**Mode:** all

**TRIGger<1|2>[:SEQuence]:LEVel:RFPower** -50 to -10DBM

This command sets the level of the RF power trigger source.

**Example:** "TRIG:LEV:RFP -20DBM"

**Characteristics:** \*RST value: -20 DBM  
SCPI: device-specific

**Mode:** all

This command is only available with option FSP-B6 (TV- and RF-Trigger).

**TRIGger<1|2>[:SEQuence]:HOLDoff** -100 to 100s

This command defines the length of the trigger delay.

A negative delay time (pretrigger) can be set in the time domain (span < 0 Hz) only.

**Example:** "TRIG:HOLD 500us"

**Characteristics:** \*RST value: 0s  
SCPI: conforming

**Mode:** all

**TRIGger<1|2>[:SEQuence]:SLOPe** POSitive | NEGative

This command selects the slope of the trigger signal. The selected trigger slope applies to all trigger signal sources .

**Example:** "TRIG:SLOP NEG"

**Characteristics:** \*RST value: POSitive  
SCPI: conforming

**Mode:** all

**TRIGger<1|2>[:SEQUence]:VIDeo:FORMat:LPFRame 525 | 625**

This command defines the line system in use (525 or 625 lines) with active TV trigger.

**Example:** "TRIG:VID:FORM:LPFR 525"

**Characteristics:** \*RST-Wert:  
SCPI: conforming

**Mode:** A-T

This command is only available with option FSP-B6 (TV- and RF-Trigger).

**TRIGger<1|2>[:SEQUence]:VIDeo:LINE:NUMBer <numeric\_value>**

With active TV trigger this command activates triggering at the horizontal sync signal of the indicated line number.

**Example:** "TRIG:VID:LINE:NUMB 17"

**Characteristics:** \*RST-Wert:  
SCPI: conforming

**Mode:** A-T

This command is only available with option FSP-B6 (TV- and RF-Trigger).

**TRIGger<1|2>[:SEQUence]:VIDeo:FIELD:SELect ALL | ODD | EVEN**

With active TV trigger this command activates triggering at the vertical sync signal.

The measurement is triggered on both fields with selection ALL, on odd fields with selection ODD and on even fields with selection EVEN.

**Example:** "TRIG:VID:FIEL:SEL ALL"

**Characteristics:** \*RST-Wert:  
SCPI: conforming

**Mode:** A-T

This command is only available with option FSP-B6 (TV- and RF-Trigger).

**TRIGger<1|2>[:SEQUence]:VIDeo:SSIGnal:POLarity NEGative | POSitive**

With active TV trigger this command selects the polarity of the video sync signal.

**Example:** "TRIG:VID:SSIG:POL NEG "

**Characteristics:** \*RST-Wert:  
SCPI: conforming

**Mode:** A-T

This command is only available with option FSP-B6 (TV- and RF-Trigger).

## UNIT Subsystem

The UNIT subsystem is used to switch the basic unit of setting parameters. A distinction is made between UNIT1 (screen A) and UNIT2 (screen B).

COMMAND	PARAMETERS	UNIT	COMMENT
UNIT<1 2> :POWer	DBM   V   A   W   DBPW   WATT   DBUV   DBMV   VOLT   DBPT   DBUA   AMPere   DBUV_M   DBUA_M		

**UNIT<1|2>:POWer** DBM | DBPW | WATT | DBUV | DBMV | VOLT |DBUA | AMPere | DB | DBPT | DBUV\_M | DBUA\_M

This command selects the default unit for the selected measurement window.

**Example:** "UNIT:POW DBUV" 'Sets the power unit for screen A to dBm.

**Characteristics:** \*RST value: DBM  
SCPI: conforming

**Mode:** A

## Alphabetical List of Commands

In the following, all remote-control commands are listed with their parameters and page numbers. Generally, they are arranged alphabetically according to the keywords of the command. The list of common commands starts the table.

Command	Parameter	Page
*CAL?		6.4
*CLS		6.4
*ESE	0 to 255	6.4
*ESR?		6.4
*IDN?		6.4
*IST?		6.4
*OPC		6.4
*OPT?		6.4
*PCB	0 to 30	6.4
*PRE	0 to 255	6.4
*PSC	0   1	6.4
*RST		6.4
*SRE	0 to 255	6.4
*STB?		6.4
*TRG		6.4
*TST?		6.4
*WAI		6.4
ABORt		6.7
CALCulate:STATistics: SCALe:X:RANGe	-10dB to 200dB	6.78
CALCulate:STATistics: SCALe:Y:LOWer	-1E-9 to 0.1	6.78
CALCulate:STATistics:APD[:STATe]	ON   OFF	6.76
CALCulate:STATistics:CCDF[:STATe]	ON   OFF	6.76
CALCulate:STATistics:NSAMples	100 to 1E9	6.77
CALCulate:STATistics:PRESet		6.78
CALCulate:STATistics:Result<1 to 3>?	MEAN PEAK CFACtor ALL	6.79
CALCulate:STATistics:SCALe:AUTO	ONCE	6.77
CALCulate:STATistics:SCALe:X:RLEVel	-130dBm to 30dBm	6.77
CALCulate:STATistics:SCALe:Y:UPPer	-1E-8 to 1.0	6.78
CALCulate<1 2>:DELTa<1 to 4>:FUNCTion:FIXed:RPOint:MAX[:PEAK]	<numeric_value>	6.14
CALCulate<1 2>:DELTa<1 to 4>:AOff		6.9
CALCulate<1 2>:DELTa<1 to 4>:FUNCTion:FIXed:RPOint:X	<numeric_value>	6.15
CALCulate<1 2>:DELTa<1 to 4>:FUNCTion:FIXed:RPOint:Y		6.14
CALCulate<1 2>:DELTa<1 to 4>:FUNCTion:FIXed:RPOint:Y:OFFSet	<numeric_value>	6.14
CALCulate<1 2>:DELTa<1 to 4>:FUNCTion:FIXed[:STATe]	ON   OFF	6.13
CALCulate<1 2>:DELTa<1 to 4>:FUNCTion:PNOise:RESult?		6.15
CALCulate<1 2>:DELTa<1 to 4>:FUNCTion:PNOise[:STATe]	ON   OFF	6.15
CALCulate<1 2>:DELTa<1 to 4>:MAXimum:LEFT		6.12
CALCulate<1 2>:DELTa<1 to 4>:MAXimum:NEXT		6.11
CALCulate<1 2>:DELTa<1 to 4>:MAXimum:RIGHT		6.12
CALCulate<1 2>:DELTa<1 to 4>:MAXimum[:PEAK]		6.11
CALCulate<1 2>:DELTa<1 to 4>:MINimum:LEFT		6.13
CALCulate<1 2>:DELTa<1 to 4>:MINimum:NEXT		6.12
CALCulate<1 2>:DELTa<1 to 4>:MINimum:RIGHT		6.13
CALCulate<1 2>:DELTa<1 to 4>:MINimum[:PEAK]		6.12

Command	Parameter	Page
CALCulate<1 2>:DELTamarker<1 to 4>:MODE	ABSolute   RELative	6.9
CALCulate<1 2>:DELTamarker<1 to 4>[:STATe]	ON   OFF	6.8
CALCulate<1 2>:DELTamarker<1 to 4>:TRACe	1 to 3	6.9
CALCulate<1 2>:DELTamarker<1 to 4>:X	0 to MAX (frequency   sweep time)	6.10
CALCulate<1 2>:DELTamarker<1 to 4>:X:RELative?		6.10
CALCulate<1 2>:DELTamarker<1 to 4>:Y?		6.11
CALCulate<1 2>:DLINe<1 2>	<numeric_value>	6.80
CALCulate<1 2>:DLINe<1 2>:STATe	ON   OFF	6.80
CALCulate<1 2>:FLINe<1 2>	0 GHz to f <sub>max</sub>	6.81
CALCulate<1 2>:FLINe<1 2>:STATe	ON   OFF	6.81
CALCulate<1 2>:LIMit<1 to 8>:ACPoweR:ACHanneL:ABSolute	-200 to 200 DBM, -200 to 200 DBM	6.23
CALCulate<1 2>:LIMit<1 to 8>:ACPoweR:ACHanneL:ABSolute:STATe	ON   OFF	6.24
CALCulate<1 2>:LIMit<1 to 8>:ACPoweR:ACHanneL:RESult?		6.25
CALCulate<1 2>:LIMit<1 to 8>:ACPoweR:ACHanneL[:RELative]	0 to 100 dB, 0 to 100 dB	6.21
CALCulate<1 2>:LIMit<1 to 8>:ACPoweR:ACHanneL[:RELative]:STATe	ON   OFF	6.22
CALCulate<1 2>:LIMit<1 to 8>:ACPoweR:ALTernate<1 2>:ABSolute	-200 to 200 DBM, -200 to 200 DBM	6.28
CALCulate<1 2>:LIMit<1 to 8>:ACPoweR:ALTernate<1 2>:ABSolute:RESult?		6.30
CALCulate<1 2>:LIMit<1 to 8>:ACPoweR:ALTernate<1 2>:ABSolute:STATe	ON   OFF	6.29
CALCulate<1 2>:LIMit<1 to 8>:ACPoweR:ALTernate<1 2>:STATe[:RELative]	ON   OFF	6.27
CALCulate<1 2>:LIMit<1 to 8>:ACPoweR:ALTernate<1 2>[:RELative]	0 to 100 DB, 0 to 100 DB	6.26
CALCulate<1 2>:LIMit<1 to 8>:ACPoweR[:STATe]	ON   OFF	6.20
CALCulate<1 2>:LIMit<1 to 8>:CLEar[:IMMediate]		6.18
CALCulate<1 2>:LIMit<1 to 8>:COMMeNt	<string>	6.18
CALCulate<1 2>:LIMit<1 to 8>:CONTRol[:DATA]	<numeric_value>,<numeric_value>..	6.31
CALCulate<1 2>:LIMit<1 to 8>:CONTRol:DOMain	FREQuency   TIME	6.31
CALCulate<1 2>:LIMit<1 to 8>:CONTRol:MODE	RELative   ABSolute	6.32
CALCulate<1 2>:LIMit<1 to 8>:CONTRol:OFFset	<numeric_value>	6.32
CALCulate<1 2>:LIMit<1 to 8>:CONTRol:SHIFt	<numeric_value>	6.32
CALCulate<1 2>:LIMit<1 to 8>:CONTRol:SPACing	LINear < LOGarithmic	6.32
CALCulate<1 2>:LIMit<1 to 8>:COPY	1 to 8   <name>	6.18
CALCulate<1 2>:LIMit<1 to 8>:DELeTe	6.19	
CALCulate<1 2>:LIMit<1 to 8>:FAIL?		6.18
CALCulate<1 2>:LIMit<1 to 8>:LOWer[:DATA]	<numeric_value>	6.33
CALCulate<1 2>:LIMit<1 to 8>:LOWer:MARGin	<numeric_value>	6.34
CALCulate<1 2>:LIMit<1 to 8>:LOWer:MODE	RELative   ABSolute	6.34
CALCulate<1 2>:LIMit<1 to 8>:LOWer:OFFset	<numeric_value>	6.34
CALCulate<1 2>:LIMit<1 to 8>:LOWer:SHIFt	<numeric_value>	6.35
CALCulate<1 2>:LIMit<1 to 8>:LOWer:SPACing	LINear   LOGarithmic	6.35
CALCulate<1 2>:LIMit<1 to 8>:LOWer:STATe	ON   OFF	6.34
CALCulate<1 2>:LIMit<1 to 8>:LOWer:THReshold	<numeric value>	6.35
CALCulate<1 2>:LIMit<1 to 8>:NAME	1 to 8   <string>	6.19
CALCulate<1 2>:LIMit<1 to 8>:STATe	ON   OFF	6.17
CALCulate<1 2>:LIMit<1 to 8>:TRACe	1 to 3	6.17
CALCulate<1 2>:LIMit<1 to 8>:UPPer[:DATA]	<num_value>,<num_value>..	6.36
CALCulate<1 2>:LIMit<1 to 8>:UPPer:MARGin	<numeric_value>	6.37
CALCulate<1 2>:LIMit<1 to 8>:UPPer:MODE	RELative   ABSolute	6.38
CALCulate<1 2>:LIMit<1 to 8>:UPPer:OFFset	<numeric_value>	6.37
CALCulate<1 2>:LIMit<1 to 8>:UPPer:SHIFt	<numeric_value>	6.38
CALCulate<1 2>:LIMit<1 to 8>:UPPer:SPACing	LINear   LOGarithmic	6.38
CALCulate<1 2>:LIMit<1 to 8>:UPPer:STATe	ON   OFF	6.37

Command	Parameter	Page
CALCulate<1 2>:LIMit<1 to 8>:UPPer:THReshold	<numeric value>	6.38
CALCulate<1 2>:LIMit<1..8>:UNIT	DBM   DBPW   WATT   DBUV   DBMV   VOLT   DBUA   AMPere   DB   DBPT   DBUV_M   DBUA_M	6.17
CALCulate<1 2>:MARKer<1 to 4>:AOFF		6.40
CALCulate<1 2>:MARKer<1 to 4>:COUNt	ON   OFF	6.42
CALCulate<1 2>:MARKer<1 to 4>:COUNt:FREQUency?		6.42
CALCulate<1 2>:MARKer<1 to 4>:COUNt:RESolution	0.1   1   10   100   1000   10000 Hz	6.42
CALCulate<1 2>:MARKer<1 to 4>:COUPled[:STATe]	ON   OFF	6.43
CALCulate<1 2>:MARKer<1 to 4>:FUNCTion:CENTer	ON   OFF	6.52
CALCulate<1 2>:MARKer<1 to 4>:FUNCTion:CSTep	ON   OFF	6.52
CALCulate<1 2>:MARKer<1 to 4>:FUNCTion:DEModulation:CONTInuous	ON   OFF99	6.50
CALCulate<1 2>:MARKer<1 to 4>:FUNCTion:DEModulation:HOLDoff	10ms to 1000s	6.50
CALCulate<1 2>:MARKer<1 to 4>:FUNCTion:DEModulation:SElect	AM   FM	6.49
CALCulate<1 2>:MARKer<1 to 4>:FUNCTion:DEModulation[:STATe]	ON   OFF	6.49
CALCulate<1 2>:MARKer<1 to 4>:FUNCTion:MDEPth:RESult?		6.51
CALCulate<1 2>:MARKer<1 to 4>:FUNCTion:MDEPth[:STATe]		6.50
CALCulate<1 2>:MARKer<1 to 4>:FUNCTion:MSUMmary?	<time offset of first pulse>, <measurement time>, <period>, < # of pulses to measure>	6.72
CALCulate<1 2>:MARKer<1 to 4>:FUNCTion:NDBDown	<numeric_value>	6.47
CALCulate<1 2>:MARKer<1 to 4>:FUNCTion:NDBDown:FREQUency?		6.48
CALCulate<1 2>:MARKer<1 to 4>:FUNCTion:NDBDown:RESult?		6.48
CALCulate<1 2>:MARKer<1 to 4>:FUNCTion:NDBDown:STATe	ON   OFF	6.47
CALCulate<1 2>:MARKer<1 to 4>:FUNCTion:NOISe:RESult?		6.49
CALCulate<1 2>:MARKer<1 to 4>:FUNCTion:NOISe[:STATe]	ON   OFF	6.49
CALCulate<1 2>:MARKer<1 to 4>:FUNCTion:POWer:PRESet	NADC   TETRA   PDC   PHS   CDPD   FWCDma   RWCDma   F8CDma   R8CDma   F19CDma   R19CDma   FW3Gppcdma   RW3Gppcdma   D2CDma   S2CDma   M2CDma   FIS95A   RIS95A   FIS95C0   RIS95C0   FJ008   RJ008   FIS95C1   RIS95C1   NONE	6.58
CALCulate<1 2>:MARKer<1 to 4>:FUNCTion:POWer:RESult:PHZ?	ACPower   CPOwer	6.57
CALCulate<1 2>:MARKer<1 to 4>:FUNCTion:POWer:RESult?	ACPower   CPOwer   OBANdwidth   OBWidth   CN   CN0	6.55
CALCulate<1 2>:MARKer<1 to 4>:FUNCTion:POWer:SElect?	ACPower   CPOwer   OBANdwidth   OBWidth   CN   CN0	6.54
CALCulate<1 2>:MARKer<1 to 4>:FUNCTion:POWer[:STATe]	OFF	6.58
CALCulate<1 2>:MARKer<1 to 4>:FUNCTion:REFerence	6.53	
CALCulate<1 2>:MARKer<1 to 4>:FUNCTion:STRack:Bandwidth[BWIDth]	10 Hz to MAX(SPAN)	6.59
CALCulate<1 2>:MARKer<1 to 4>:FUNCTion:STRack:THReshold	-330 dBm to +30 dBm	6.60
CALCulate<1 2>:MARKer<1 to 4>:FUNCTion:STRack:TRACe	1 to 3	6.60
CALCulate<1 2>:MARKer<1 to 4>:FUNCTion:STRack[:STATe]	ON   OFF	6.59
CALCulate<1 2>:MARKer<1 to 4>:FUNCTion:SUMMery:AOFF		6.71
CALCulate<1 2>:MARKer<1 to 4>:FUNCTion:SUMMery:AVERage	ON   OFF	6.70
CALCulate<1 2>:MARKer<1 to 4>:FUNCTion:SUMM:MEAN:AVER:RESult?		6.66
CALCulate<1 2>:MARKer<1 to 4>:FUNCTion:SUMM:MEAN:PHOLd:RESult?		6.67
CALCulate<1 2>:MARKer<1 to 4>:FUNCTion:SUMMery:MEAN:RESult?		6.66
CALCulate<1 2>:MARKer<1 to 4>:FUNCTion:SUMMery:MEAN[:STATe]	ON   OFF	6.65
CALCulate<1 2>:MARKer<1 to 4>:FUNCTion:SUMMery:MODE	ABSolute   RELative	6.70
CALCulate<1 2>:MARKer<1 to 4>:FUNCTion:SUMMery:PHOLd	ON   OFF	6.69
CALCulate<1 2>:MARKer<1 to 4>:FUNCTion:SUMM:PPEak:AVER:RESult?		6.63

Command	Parameter	Page
CALCulate<1 2>:MARKer<1 to 4>:FUNction:SUMM:PPEak:PHOLd:RESult?		6.63
CALCulate<1 2>:MARKer<1 to 4>:FUNction:SUMM:ary:PPEak:RESult?		6.62
CALCulate<1 2>:MARKer<1 to 4>:FUNction:SUMM:ary:PPEak[:STATe]	ON   OFF	6.62
CALCulate<1 2>:MARKer<1 to 4>:FUNction:SUMM:ary:REFerence:AUTO	ONCE	6.71
CALCulate<1 2>:MARKer<1 to 4>:FUNction:SUMM:ary:RMS:AVER:RESult?		6.64
CALCulate<1 2>:MARKer<1 to 4>:FUNction:SUMM:ary:RMS:PHOLd:RESult?		6.65
CALCulate<1 2>:MARKer<1 to 4>:FUNction:SUMM:ary:RMS:RESult?		6.64
CALCulate<1 2>:MARKer<1 to 4>:FUNction:SUMM:ary:RMS[:STATe]	ON   OFF	6.64
CALCulate<1 2>:MARKer<1 to 4>:FUNction:SUMM:SDEV:AVER:RESult?		6.68
CALCulate<1 2>:MARKer<1 to 4>:FUNction:SUMM:SDEV:PHOLd:RESult?		6.69
CALCulate<1 2>:MARKer<1 to 4>:FUNction:SUMM:ary:SDEViation:RESult?		6.68
CALCulate<1 2>:MARKer<1 to 4>:FUNction:SUMM:ary:SDEViation[:STATe]	ON   OFF	6.67
CALCulate<1 2>:MARKer<1 to 4>:FUNction:SUMM:ary:STATe	ON   OFF	6.62
CALCulate<1 2>:MARKer<1 to 4>:FUNction:TOI:RESult?		6.52
CALCulate<1 2>:MARKer<1 to 4>:FUNction:TOI[:STATe]	ON   OFF	6.51
CALCulate<1 2>:MARKer<1 to 4>:FUNction:ZOOM	<numeric_value>	6.48
CALCulate<1 2>:MARKer<1 to 4>:LOEXclude	ON   OFF	6.43
CALCulate<1 2>:MARKer<1 to 4>:MAXimum:LEFT		6.45
CALCulate<1 2>:MARKer<1 to 4>:MAXimum:NEXT		6.44
CALCulate<1 2>:MARKer<1 to 4>:MAXimum:RIGHT		6.45
CALCulate<1 2>:MARKer<1 to 4>:MAXimum[:PEAK]		6.44
CALCulate<1 2>:MARKer<1 to 4>:MINimum:LEFT		6.46
CALCulate<1 2>:MARKer<1 to 4>:MINimum:NEXT		6.46
CALCulate<1 2>:MARKer<1 to 4>:MINimum:RIGHT		6.46
CALCulate<1 2>:MARKer<1 to 4>:MINimum[:PEAK]		6.45
CALCulate<1 2>:MARKer<1 to 4>:PEXCursion	<numeric_value>	6.46
CALCulate<1 2>:MARKer<1 to 4>:SCOupled[:STATe]	ON   OFF	6.43
CALCulate<1 2>:MARKer<1 to 4>:TRACe	1 to 3	6.40
CALCulate<1 2>:MARKer<1 to 4>:X	0 to MAX (frequency   sweep time)	6.40
CALCulate<1 2>:MARKer<1 to 4>:X:SLIMits:LEFT	0 to MAX (frequency sweep time)	6.41
CALCulate<1 2>:MARKer<1 to 4>:X:SLIMits:RIGHT	0 to MAX (frequency sweep time)	6.41
CALCulate<1 2>:MARKer<1 to 4>:X:SLIMits[:STATe]	ON   OFF	6.40
CALCulate<1 2>:MARKer<1 to 4>:Y:PERCent	0 to 100%	6.44
CALCulate<1 2>:MARKer<1 to 4>:Y?		6.43
CALCulate<1 2>:MARKer<1 to 4>[:STATe]	ON   OFF	6.39
CALCulate<1 2>:MATH[:EXPReSSion][:DEFine]	<expr>	6.73
CALCulate<1 2>:MATH:MODE	LINear   LOGarithmic	6.74
CALCulate<1 2>:MATH:POSition	-100PCT to 200PCT	6.73
CALCulate<1 2>:MATH:STATe	ON   OFF	6.74
CALCulate<1 2>:PEAKsearch PSEarch: METHod	SUBRange   PEAK	6.75
CALCulate<1 2>:PEAKsearch PSEarch:MARGin	MINimum .. MAXimum	6.75
CALCulate<1 2>:PEAKsearch PSEarch:SUBRanges	1 to 500	6.75
CALCulate<1 2>:PEAKsearch PSEarch[:IMMediate]		6.75
CALCulate<1 2>:THReshold	MINimum to MAXimum (depending on current unit)	6.80
CALCulate<1 2>:THReshold:STATe	ON   OFF	6.81
CALCulate<1 2>:TLINe<1 2>	0 to 1000s	6.81
CALCulate<1 2>:TLINe<1 2>:STATe	ON   OFF	6.81
CALCulate<1 2>:UNIT:POWER	DBM   V  A  W   DBPW   WATT   DBUV   DBMV   VOLT   DBUA   AMPere   DBPT	6.82



Command	Parameter	Page
CALibration:ABORt		6.83
CALibration[:ALL]		6.83
CALibration:RESult?		6.84
CALibration:STATe	ON   OFF	6.84
DIAGnostic<1 2>:SERVice:CSOURce[:POWER]	<numeric_value>	6.86
DIAGnostic<1 2>:SERVice:INPut:PULSed:PRATe	10 kHz   100 kHz   200 kHz   500 kHz   1 MHz   2 MHz   4 MHz   8 MHz	6.85
DIAGnostic<1 2>:SERVice:INPut:PULSed[:State]	ON   OFF	6.85
DIAGnostic<1 2>:SERVice:INPut[:SElect]	CALibration   RF	6.85
DIAGnostic<1 2>:SERVice:NSOURce	ON OFF	6.86
DIAGnostic<1 2>:SERVice:SFUNction	<string>...	6.86
DIAGnostic<1 2>:SERVice:STESt:RESult?		6.86
DISPlay:ANNotation:FREQuency	ON   OFF	6.88
DISPlay:BARGraph:LEVel:LOWer?		6.94
DISPlay:BARGraph:LEVel:UPPer		6.94
DISPlay:CMAP<1 to 32>:DEFault<1 2>		6.89
DISPlay:CMAP<1 to 32>:HSL	0 to 1 (tint), 0 to 1 (saturation), 0 to 1 (brightness)	6.89
DISPlay:CMAP<1 to 32>:PDEFined	<color>	6.90
DISPlay:FORmat	SINGle   SPLit	6.88
DISPlay:LOGO	ON   OFF	6.88
DISPlay:PSAVE:HOLDoff	0 to 60	6.88
DISPlay:PSAVE[:STATe]	ON   OFF	6.88
DISPlay[:WINDow<1 2>]:SElect		6.90
DISPlay[:WINDow<1 2>]:TEXT:STATe	ON   OFF	6.91
DISPlay[:WINDow<1 2>]:TEXT[:DATA]	<string>	6.90
DISPlay[:WINDow<1 2>]:TIME	ON   OFF	6.91
DISPlay[:WINDow<1 2>]:TRACe<1 to 3>:MODE	WRITe   VIEW   AVERAge   MAXHold   MINHold	6.93
DISPlay[:WINDow<1 2>]:TRACe<1 to 3>:SYMBol	CROSS   OFF	6.94
DISPlay[:WINDow<1 2>]:TRACe<1 to 3>:X:SPACing	LINear   LOGarithmic	6.91
DISPlay[:WINDow<1 2>]:TRACe<1 to 3>:Y:SPACing	LINear   LOGarithmic   PERCent	6.93
DISPlay[:WINDow<1 2>]:TRACe<1 to 3>:Y[:SCALE]	10dB to 200dB	6.91
DISPlay[:WINDow<1 2>]:TRACe<1 to 3>:Y[:SCALE]:BOTTom	<numeric_value>	6.93
DISPlay[:WINDow<1 2>]:TRACe<1 to 3>:Y[:SCALE]:MODE	ABSolute   RELative	6.91
DISPlay[:WINDow<1 2>]:TRACe<1 to 3>:Y[:SCALE]:RLEVel	-200dBm 130dBm to 30dBm	6.92
DISPlay[:WINDow<1 2>]:TRACe<1 to 3>:Y[:SCALE]:RLEVel:OFFSet	-200dB to 200dB	6.92
DISPlay[:WINDow<1 2>]:TRACe<1 to 3>:Y[:SCALE]:RPOSition	0 to 100 PCT	6.92
DISPlay[:WINDow<1 2>]:TRACe<1 to 3>:Y[:SCALE]:RVALue	<numeric_value>	6.92
DISPlay[:WINDow<1 2>]:TRACe<1 to 3>[:STATe]	ON   OFF	6.93
FORMat[:DATA]	ASCIi   REAL   UINT [,32]	6.95
FORMat:DEXPort:DSEParator	POINt COMMa	6.95
HCOPY:ABORt		6.96
HCOPY:CMAP<1 to 32>:DEFault		6.96
HCOPY:CMAP<1 to 32>:HSL	0..1,0..1,0..1	6.97
HCOPY:CMAP<1 to 32>:PDEFined	<color>	6.98
HCOPY:DESTination<1 2>	MMEM'   'SYST:COMM:PRIN'   'SYST:COMM:CLIP'	6.98
HCOPY:DEVice:COLor	ON   OFF	6.99
HCOPY:DEVice:ITEM:ALL		6.100
HCOPY:DEVice:LANGUage<1 2>	GDI   WMF   EWMF   BMP	6.99

Command	Parameter	Page
HCOPY[:IMMediate]		6.99
HCOPY:ITEM:WINDow<1 2>:TABle:STATe	ON   OFF	6.100
HCOPY:ITEM:WINDow<1 2>:TEXT	<string>	6.100
HCOPY:ITEM:WINDow<1 2>:TRACe:STATe	ON   OFF	6.100
HCOPY:PAGE:ORientation<1 2>	LANDscape   PORTRait	6.100
HOLD		6.7
INITiate<1 2>:CONMeas		6.101
INITiate<1 2>:CONTinuous	ON   OFF	6.101
INITiate<1 2>:DISPlay	ON   OFF	6.102
INITiate<1 2>[:IMMediate]		6.102
INPut<1 2>:ATTenuation	0 to 70dB	6.103
INPut<1 2>:ATTenuation:AUTO	ON   OFF	6.104
INPut<1 2>:ATTenuation:PROTection	ON   OFF	6.104
INPut<1 2>:GAIN:AUTO	ON   OFF	6.106
INPut<1 2>:GAIN:STATe	ON   OFF	6.105
INPut<1 2>:IMPedance	50   75	6.105
INPut<1 2>:LISN:PEARth	GROunded   FLOating	6.104
INPut<1 2>:LISN:PHASe	L1   L2   L3   N	6.104
INPut<1 2>:LISN[:TYPE]	TWOPhase   FOURphase   OFF	6.104
INPut<1 2>:UPORt:STATe	ON   OFF	6.105
INPut<1 2>:UPORt[:VALue]		6.105
INSTRument:COUPlE	NONE   RLEVel   CF_B   CF_A	6.107
INSTRument:NSElect	1   6	6.107
INSTRument[:SElect]	RECeiver   SANalyzer	6.107
MMEMory:CATalog?	path	6.110
MMEMory:CDIRectory	directory name	6.110
MMEMory:CLear:ALL		6.117
MMEMory:CLear:STATe	1,Path	6.117
MMEMory:COMMeNt	<string>	6.120
MMEMory:COpy	path, file name	6.110
MMEMory:DATA	<file name>,<block data>	6.111
MMEMory:DELeTe	path, file name	6.112
MMEMory:INITialize	'A:'	6.112
MMEMory:LOAD:AUTO	1,Path	6.114
MMEMory:LOAD:STATe	path, file name	6.113
MMEMory:MDIRectory	path	6.114
MMEMory:MOVE	path, file name	6.115
MMEMory:MSIS	'A:'   'D:'	6.115
MMEMory:NAME	path, file name	6.115
MMEMory:RDIRectory	directory name	6.116
MMEMory:SElect[:ITEM]:ALL		6.120
MMEMory:SElect[:ITEM]:DEFault		6.120
MMEMory:SElect[:ITEM]:FINAl	ON   OFF	6.119
MMEMory:SElect[:ITEM]:HWSettings	ON   OFF	6.118
MMEMory:SElect[:ITEM]:LINes:ALL	ON   OFF	6.118
MMEMory:SElect[:ITEM]:NONE		6.120
MMEMory:SElect[:ITEM]:SCData	ON   OFF	6.119
MMEMory:SElect[:ITEM]:TRACe[:ACTive]	ON   OFF	6.118
MMEMory:SElect[:ITEM]:TRANSDucer[:ACTive]	ON   OFF	6.119
MMEMory:SElect[:ITEM]:TRANSDucer:ALL	ON   OFF	6.119

Command	Parameter	Page
MMEMory:STORe:FINal	Path	6.117
MMEMory:STORe<1 2>:STATe	path, file name	6.116
MMEMory:STORe<1 2>:TRACe	1 to 3,Path	6.116
OUTPut[:]STATe]	ON   OFF	6.121
OUTPut:UPORt:STATe	ON   OFF	6.121
OUTPut:UPORt[:]VALue]	#B00000000 to #B11111111	6.121
[SENSe<1 2>:]AVERAge:COUnT	0 to 256	6.122
[SENSe<1 2>:]AVERAge:TYPE	VIDeo   LINear	6.123
[SENSe<1 2>:]AVERAge[:]STATe<1 to 3>]	ON   OFF	6.123
[SENSe<1 2>:]BANDwidth BWIDth:VIDeo	1Hz to 10MHz	6.126
[SENSe<1 2>:]BANDwidth BWIDth:VIDeo:AUTO	ON   OFF	6.126
[SENSe<1 2>:]BANDwidth BWIDth:VIDeo:RATio	0.01 to 1000	6.126
[SENSe<1 2>:]BANDwidth BWIDth:VIDeo:TYPE	LINear   LOGarithmic	6.126
[SENSe<1 2>:]BANDwidth BWIDth[:]RESolution]	10Hz to 10MHz (Analog Filter) 1Hz to 30 kHz (FFT-Filter)	6.124
[SENSe<1 2>:]BANDwidth BWIDth[:]RESolution]:AUTO	ON   OFF	6.125
[SENSe<1 2>:]BANDwidth BWIDth[:]RESolution]:RATio	0.0001 to 1	6.125
[SENSe<1 2>:]BANDwidth BWIDth[:]RESolution]:TYPE	NORMal   FFT   CFILter   RRC   NOISe   PULSe	6.125
[SENSe<1 2>:]CORRection:COLLect[:]ACQuire]	THROugh   OPEN	6.128
[SENSe<1 2>:]CORRection:METHod	TRANSmisSion   REFLEXion	6.128
[SENSe<1 2>:]CORRection:RECall		6.128
[SENSe<1 2>:]CORRection:TRANSDucer:DATA	<freq>,<level>..	6.129
[SENSe<1 2>:]CORRection:TRANSDucer:DELeTe		6.130
[SENSe<1 2>:]CORRection:TRANSDucer:SCALing	LINear LOGarithmic	6.129
[SENSe<1 2>:]CORRection:TRANSDucer:SELect	<name>	6.129
[SENSe<1 2>:]CORRection:TRANSDucer:UNIT	<string>	6.129
[SENSe<1 2>:]CORRection:TRANSDucer[:]STATe]	ON   OFF	6.130
[SENSe<1 2>:]CORRection:TSET:BReak	ON   OFF	6.131
[SENSe<1 2>:]CORRection:TSET:DELeTe		6.131
[SENSe<1 2>:]CORRection:TSET:RANGe<1 to 10>	<freq>,<freq>,<name>..	6.131
[SENSe<1 2>:]CORRection:TSET:SELect	<name>	6.130
[SENSe<1 2>:]CORRection:TSET:UNIT	<string>	6.130
[SENSe<1 2>:]CORRection:TSET[:]STATe]	ON   OFF	6.131
[SENSe<1 2>:]CORRection[:]STATe]	ON   OFF	6.127
[SENSe<1 2>:]DEMod	OFF   AM   FM	6.132
[SENSe<1 2>:]DETEctor:RECEiver[:]FUNCTION]	POSitive   NEGative   RMS   AVERAge   QPEak	6.134
[SENSe<1 2>:]DETEctor<1 to 3>:FMEasurement	NEGative   POSitive   RMS   AVERAge   QPEak   ACVidEo	6.134
[SENSe<1 2>:]DETEctor<1 to 3>[:]FUNCTION]	APEak   NEGative   POSitive   SAMPlE   RMS   AVERAge   QPEak	6.133
[SENSe<1 2>:]DETEctor<1 to 3>[:]FUNCTION]:AUTO	ON   OFF	6.133
[SENSe<1 2>:]FREQUency:CENTer	0 GHz to $f_{max}$	6.135
[SENSe<1 2>:]FREQUency:CENTer:STEP	0 to $f_{max}$	6.135
[SENSe<1 2>:]FREQUency:CENTer:STEP:LINK	SPAN   RBW   OFF	6.135
[SENSe<1 2>:]FREQUency:CENTer:STEP:LINK:FACTor	1 to 100 PCT	6.136
[SENSe<1 2>:]FREQUency:MODE	CW FIXed   SWEEp	6.137
[SENSe<1 2>:]FREQUency:OFFSet	<numeric_value>	6.137
[SENSe<1 2>:]FREQUency:SPAN	0 GHz to $f_{max}$	6.136
[SENSe<1 2>:]FREQUency:SPAN:FULL		6.136
[SENSe<1 2>:]FREQUency:START	0 GHz to $f_{max}$	6.136

Command	Parameter	Page
[SENSe<1 2>:]FREQUency:STOP	0 GHz to $f_{max}$	6.136
[SENSe<1 2>:]FREQUency[:CW FIXed]	<numeric_value>	6.137
[SENSe<1 2>:]FREQUency[:CW FIXed]:STEP	<numeric_value>	6.137
[SENSe<1 2>:]LIST:POWer:RESult	6.143	
[SENSe<1 2>:]LIST:POWer:SET	<PEAK meas>,<RMS meas>,<AVG meas>,<trigger mode>,<trigger slope>,<trigger offset>,<gate length>	6.142
[SENSe<1 2>:]LIST:POWer:STATe OFF	6.143	
[SENSe<1 2>:]LIST:POWer[SEQUence]	<analyzer freq>,<ref level>,<rf att>,<OFF>,<filter type>,<rbw>,<vbw>,<meas time>,<trigger level>,...	6.139
[SENSe<1 2>:]MPOWer:RESult[:LIST]	6.147	
[SENSe<1 2>:]MPOWer[:SEQUence]	<analyzer freq>,<rbw>,<meas time>,<trigger source>,<trigger level>,<trigger offset>,<type of meas>,<# of meas>	6.145
[SENSe<1 2>:]POWer:ACHannel:ACPairs	0 to 3	6.149
[SENSe<1 2>:]POWer:ACHannel:BANDwidth BWIDth:ACHannel	100 to 1000MHz	6.150
[SENSe<1 2>:]POWer:ACHannel:BANDwidth BWIDth:ALTErnatE<1 2>	100 to 2000MHz	6.150
[SENSe<1 2>:]POWer:ACHannel:BANDwidth BWIDth[:CHANnel]	100 to 1000 MHz	6.149
[SENSe<1 2>:]POWer:ACHannel:MODE	ABSolute   RELative	6.150
[SENSe<1 2>:]POWer:ACHannel:PRESet	ACPowEr   CPOWer   OBANdwidth   OBWidth	6.151
[SENSe<1 2>:]POWer:ACHannel:PRESet:RLEVel		6.151
[SENSe<1 2>:]POWer:ACHannel:REFerence:AUTO	ONCE	6.150
[SENSe<1 2>:]POWer:ACHannel:SPACing:ACHannel	100 to 2000MHz	6.148
[SENSe<1 2>:]POWer:ACHannel:SPACing:ALTErnatE<1 2>	100 to 2000MHz	6.149
[SENSe<1 2>:]POWer:BANDwidth BWIDth	10 to 99.9PCT	6.151
[SENSe<1 2>:]POWer:HSPeEd	ON   OFF	6.152
[SENSe<1 2>:]POWer:TRACe	1 to 3	6.152
[SENSe<1 2>:]ROSCillator:SOURce	INTernal   EXTernal	6.153
[SENSe<1 2>:]ROSCillator[:INTernal]:TUNe	0 to 4095	6.153
[SENSe<1 2>:]ROSCillator[:INTernal]:TUNe:SAVe		6.153
[SENSe<1 2>:]SCAN<1 to 10>:BANDwidth:RESolution	<numeric_vaue>	6.155
[SENSe<1 2>:]SCAN<1 to 10>:INPut:ATTenuation	dB <sub>min</sub> to dB <sub>max</sub>	6.155
[SENSe<1 2>:]SCAN<1 to 10>:INPut:ATTenuation:AUTO	ON   OFF	6.156
[SENSe<1 2>:]SCAN<1 to 10>:INPut:GAIN:AUTO	ON   OFF	6.156
[SENSe<1 2>:]SCAN<1 to 10>:INPut:GAIN:STATe	ON   OFF	6.156
[SENSe<1 2>:]SCAN<:RANGes[COUNT]	1 to 10	6.156
[SENSe<1 2>:]SCAN<1 to 10>:STARt	$f_{min}$ to $f_{max}$	6.154
[SENSe<1 2>:]SCAN<1 to 10>:STEP	1 Hz to $f_{max}$   0.1% to 100%	6.155
[SENSe<1 2>:]SCAN<1 to 10>:STOP	$f_{min}$ to $f_{max}$	6.154
[SENSe<1 2>:]SCAN<1 to 10>:TIME	100 $\mu$ s to 100 s	6.155
[SENSe<1 2>:]SWEep:COUNT	0 to 32767	6.158
[SENSe<1 2>:]SWEep:EGATe	ON   OFF	6.158
[SENSe<1 2>:]SWEep:EGATe:HOLDoff	125ns to 100s	6.159
[SENSe<1 2>:]SWEep:EGATe:LENGth	0 to 100s	6.159
[SENSe<1 2>:]SWEep:EGATe:POLarity	POSitive   NEGative	6.159
[SENSe<1 2>:]SWEep:EGATe:SOURce	EXTernal   IFPower   RFPower	6.160
[SENSe<1 2>:]SWEep:EGATe:TYPE	LEVel   EDGE	6.159
[SENSe<1 2>:]SWEep:SPACing	LINear   LOGarithmic   AUTO	6.160
[SENSe<1 2>:]SWEep:TIME	100 $\mu$ s to 100s   15 sec   2,5ms to 16000s   1 $\mu$ s to 16000s	6.157

Command	Parameter	Page
[SENSe<1 2>:]SWEep:TIME:AUTO	ON   OFF	6.157
[SENSe<1 2>:]SWEep:TIME:FMEasurement	<numeric_value>	6.158
[SENSe<1 2>:]TV:CCVS	INTernal   EXTernal	6.161
[SENSe<1 2>:]TV[:STATe]	ON   OFF	6.161
SOURce<1 2>:AM:STATe	ON   OFF	6.162
SOURce<1 2>:DM:STATe	ON   OFF	6.162
SOURce<1 2>:EXTernal<1 2>:FREQuency:OFFSet	<numeric_value>	6.167
SOURce<1 2>:EXTernal<1 2>:FREQuency:SWEep[:STATe]	ON   OFF	6.167
SOURce<1 2>:EXTernal<1 2>:FREQuency[:FACTor]:DENominator	<numeric_value>	6.166
SOURce<1 2>:EXTernal<1 2>:FREQuency[:FACTor]:NUMerator	<numeric_value>	6.166
SOURce<1 2>:EXTernal<1 2>:POWer[:LEVel]	<numeric_value>	6.167
SOURce<1 2>:EXTernal<1 2>:ROSCillator[:SOURce]	INTernal   EXTernal	6.168
SOURce<1 2>:EXTernal<1 2>[:STATe]	ON   OFF	6.165
SOURce<1 2>:FM:DEVIation	100Hz to 10MHz	6.163
SOURce<1 2>:FREQuency:OFFSet	-150 MHz to 150 MHz	6.163
SOURce<1 2>:POWer[:LEVel][:IMMediate]:OFFSet	-200 dB to +200 dB	6.164
SOURce<1 2>:POWer[:LEVel][:IMMediate][:AMPLitude]	<numeric_value>	6.164
STATus:OPERation:CONDition?		6.170
STATus:OPERation:ENABLE	0 to 65535	6.170
STATus:OPERation[:EVENT]?		6.170
STATus:OPERation:NTRansition	0 to 65535	6.171
STATus:OPERation:PTRansition	0 to 65535	6.171
STATus:PRESet		6.171
STATus:QUEStionable:ACPLimit:CONDition?		6.176
STATus:QUEStionable:ACPLimit:ENABLE	0 to 65535	6.177
STATus:QUEStionable:ACPLimit:NTRansition	0 to 65535	6.177
STATus:QUEStionable:ACPLimit:PTRansition	0 to 65535	6.177
STATus:QUEStionable:ACPLimit[:EVENT]?		6.176
STATus:QUEStionable:CONDition?		6.171
STATus:QUEStionable:ENABLE	0 to 65535	6.172
STATus:QUEStionable[:EVENT]?		6.171
STATus:QUEStionable:NTRansition	0 to 65535	6.172
STATus:QUEStionable:PTRansition	0 to 65535	6.172
STATus:QUEStionable:FREQuency:CONDition?		6.177
STATus:QUEStionable:FREQuency:ENABLE	0 to 65535	6.178
STATus:QUEStionable:FREQuency[:EVENT]?		6.177
STATus:QUEStionable:FREQuency:NTRansition	0 to 65535	6.178
STATus:QUEStionable:FREQuency:PTRansition	0 to 65535	6.178
STATus:QUEStionable:LIMit:CONDition?		6.173
STATus:QUEStionable:LIMit:ENABLE	0 to 65535	6.174
STATus:QUEStionable:LIMit[:EVENT]?		6.173
STATus:QUEStionable:LIMit:NTRansition	0 to 65535	6.174
STATus:QUEStionable:LIMit:PTRansition	0 to 65535	6.174
STATus:QUEStionable:LMARgin:CONDition?		6.174
STATus:QUEStionable:LMARgin:ENABLE	0 to 65535	6.175
STATus:QUEStionable:LMARgin[:EVENT]?		6.174
STATus:QUEStionable:LMARgin:NTRansition	0 to 65535	6.175
STATus:QUEStionable:LMARgin:PTRansition	0 to 65535	6.175
STATus:QUEStionable:POWer:CONDition?		6.172
STATus:QUEStionable:POWer:ENABLE	0 to 65535	6.173

Command	Parameter	Page
STATus:QUEStionable:POWER[:EVENT]?		6.172
STATus:QUEStionable:POWER:NTRansition	0 to 65535	6.173
STATus:QUEStionable:POWER:PTRansition	0 to 65535	6.173
STATus:QUEStionable:SYNC:CONDition?		6.175
STATus:QUEStionable:SYNC:ENABLE	0 to 65535	6.176
STATus:QUEStionable:SYNC[:EVENT]?		6.175
STATus:QUEStionable:SYNC:NTRansition	0 to 65535	6.176
STATus:QUEStionable:SYNC:PTRansition	0 to 65535	6.176
STATus:QUEStionable:TRANsducer:CONDition?		6.178
STATus:QUEStionable:TRANsducer:ENABLE	0 to 65535	6.179
STATus:QUEStionable:TRANsducer[:EVENT]?		6.178
STATus:QUEStionable:TRANsducer:NTRansition	0 to 65535	6.179
STATus:QUEStionable:TRANsducer:PTRansition	0 to 65535	6.179
STATus:QUEue[:NEXT]?		6.179
SYSTem:COMMunicate:GPIB:RDEvice:GENerator<1 2>:ADDReSS	0 to 30	6.181
SYSTem:COMMunicate:GPIB:RDEvice:GENerator<1 2>:LINK	GPIB   TTL	6.182
SYSTem:COMMunicate:GPIB:RDEvice:GENerator<1 2>:TYPE	<name>	6.183
SYSTem:COMMunicate:GPIB[:SELF]:ADDReSS	0 to 30	6.181
SYSTem:COMMunicate:GPIB[:SELF]:RTERminator	LFEOI   EOI	6.181
SYSTem:COMMunicate:PRINter:ENUMerate:FIRSt?		6.186
SYSTem:COMMunicate:PRINter:ENUMerate:NEXT?		6.186
SYSTem:COMMunicate:PRINter:SELect	<printer_name>	6.186
SYSTem:COMMunicate:SERial:CONTRol:DTR	IBFull   OFF	6.184
SYSTem:COMMunicate:SERial:CONTRol:RTS	IBFull   OFF	6.184
SYSTem:COMMunicate:SERial[:RECeive]:BAUD	110   300   600   1200   2400   9600   19200	6.184
SYSTem:COMMunicate:SERial[:RECeive]:BITS	7   8	6.185
SYSTem:COMMunicate:SERial[:RECeive]:PACE	XON   NONE	6.185
SYSTem:COMMunicate:SERial[:RECeive]:PARity[:TYPE]	EVEN   ODD   NONE	6.185
SYSTem:COMMunicate:SERial[:RECeive]:SBITs	1   2	6.185
SYSTem:DATE	1980 to 2099, 1 to 12, 1 to 31	6.187
SYSTem:DISPlay:FPANel	ON   OFF	6.187
SYSTem:ERRor:CLEar:ALL		6.188
SYSTem:ERRor:LIST?		6.188
SYSTem:ERRor?		6.187
SYSTem:FIRMWare:UPDate	<path>	6.188
SYSTem:PASSword[:CENable]	'password'	6.189
SYSTem:PRESet		6.189
SYSTem:SET	<block>	6.189
SYSTem:SPEaker:VOLume	0 to 1	6.189
SYSTem:TIME	0 to 23, 0 to 59, 0 to 59	6.190
SYSTem:UPDate	ON   OFF	6.187
SYSTem:VERSion?		6.190
TRACe:COPIY	TRACE1   TRACE2   TRACE3   TRACE4 , TRACE1   TRACE2   TRACE3   TRACE4	6.193
TRACe[:DATA]	TRACE1   TRACE2   TRACE3   TRACE4  SINGLE  SCAN  STATus  FINAL1  FINAL2  FINAL3  ABITstream   PWCDp, <block>   <numeric_value>	6.191
TRACe<1 2>:IQ:AVERage:COUNT	0 to 32767	6.196
TRACe<1 2>:IQ:AVERage[:STATe]	ON   OFF	6.196

Command	Parameter	Page
TRACe<1 2>:IQ:SRATe	16kHz to 32MHz	6.201
TRACe<1 2>:IQ:STATe]	ON   OFF	6.201
TRIGger<1 2>[:SEQuence]:HOLDoff	-100 to 100 s	6.203
TRIGger<1 2>[:SEQuence]:LEVel:IFPower	-30 to -10 DBM	6.203
TRIGger<1 2>[:SEQuence]:LEVel:RFPower	-50 to -10 DBM	6.203
TRIGger<1 2>[:SEQuence]:LEVel:VIDeo	0 to 100 PCT	6.203
TRIGger<1 2>[:SEQuence]:SLOPe	POSitive   NEGative	6.203
TRIGger<1 2>[:SEQuence]:SOURce	IMMediate   EXTernal   VIDeo   IFPower   RFPower   TV	6.202
TRIGger<1 2>[:SEQuence]:VIDeo:FIELD:SElect	ALL   ODD   EVEN	6.204
TRIGger<1 2>[:SEQuence]:VIDeo:FORMat:LPFRame	525   625	6.204
TRIGger<1 2>[:SEQuence]:VIDeo:LINE:NUMBer	<numeric_value>	6.204
TRIGger<1 2>[:SEQuence]:VIDeo:SSIGnal:POLarity	NEGative   POSitive	6.204
UNIT:POWer	DBM   DBPW   WATT   DBUV   DBMV   VOLT   DBUA   AMPere   DB   DBT   DBUV_M   DBUA_M   DBUV_M   DBUA_M	6.205

Table of Softkeys and Hotkeys with IEC/IEEE Bus Command Assignment

Receiver Mode

<b>RECEIVER</b>	
RECEIVER FREQUENCY	: [SENSe<1 2>:]FREQuency:CEnter <num_value>
DETECTOR	--
MAX PEAK	: [SENSe<1 2>:]DETEctor:RECEiver[:FUNction] POSitive
MIN PEAK	: [SENSe<1 2>:]DETEctor:RECEiver[:FUNction] NEGative
QUASIEPEAK	: [SENSe<1 2>:]DETEctor:RECEiver[:FUNction] QPEak
AVERAGE	: [SENSe<1 2>:]DETEctor:RECEiver[:FUNction] AVERAge
RMS	: [SENSe<1 2>:]DETEctor:RECEiver[:FUNction] RMS
QP RBW UNCOUPLED	: [SENSe<1 2>:]BANDwidth[:RESolution]:AUTO ON   OFF
MEAS TIME	: [SENSe<1 2>:]SWEep:TIME <num_value>
DEMODO	--
DEMODO ON OFF	: [SENSe<1 2>:]DEMod OFF (automatically executed during IEC/IEEE-bus operation switched on with AM   FM)
AM	: [SENSe<1 2>:]DEMod AM
FM	: [SENSe<1 2>:]DEMod FM
FINAL MEAS	--
PEAK SEARCH	: CALCulate<1 2>:PEAKsearch PSEarch[:IMMediate]
EDIT PEAK LIST	-
EDIT FREQUENCY	--
INSERT	--
DELETE	--
SORT BY FREQUENCY	--



SORT BY DELTA LIM	--
ASCII EXPORT	:FORMat ASCii :MMEMory:STORE:FINal 1,<path with file name>
DECIM SEP .	:FORMat:DEXPort:DSEPARATOR POINT COMMA
NO OF PEAKS	:CALCulate<1 2>:PEAKsearch PSEarch:SUBRanges 1 ... 500
PEAKS SUBRANGES	:CALCulate<1 2>:PEAKsearch PSEarch:METHOD SUBRange   PEAK
MARGIN	:CALCulate<1 2>:PEAKsearch PSEarch:MARGIN -200 dB ... 200 dB
FINAL MEAS TIME	:[SENSe<1 2>:]SWEep:TIME:FMEasurement <num_value>
AUTOMATIC FINAL	--
INTER ACTIVE	--
RUN FINAL MEAS	--
ESH2-Z5 ENV 4200	:INPut:LISN[:TYPE] FOURphase
ESHR-Z5	:INPut:LISN[:TYPE] TWOPHase
OFF	:INPut:LISN[:TYPE] OFF
PRESCAN PHASES	See FINAL PHASES
FINAL PHASES	--
PHASE N	:INPut:LISN:PHASe N
PHASE L1	:INPut:LISN:PHASe L1
PHASE L2	:INPut:LISN:PHASe L2
PHASE L3	:INPut:LISN:PHASe L3
PE GROUNDED	:INPut:LISN:PEARth GROUnded
PE FLOATING	:INPut:LISN:PEARth FLOating
RUN SCAN	:INITiate2[:IMMediate]
HOLD SCAN	:HOLD
CONT AT REC FREQ	:INIT:CONMeasure
STOP SCAN	:ABORT

**FREQUENCY Key**

<b>FREQ</b>	
RECEIVER FREQUENCY	: [SENSe:] FREQuency: CeNTER <num_value>
STEP SIZE	
AUTO COARSE	no corresponding IEC/IEEE-bus command
AUTO FINE	no corresponding IEC/IEEE-bus command
STEP SIZE MANUAL	: [SENSe:] FREQuency: CeNTER: STEP <num_value>
STEP SIZE = FREQ	no corresponding IEC/IEEE-bus command
START	: [SENSe:] FREQuency: STArT <num_value>
STOP	: [SENSe:] FREQuency: STOP <num_value>

**SPAN Key**

<b>SPAN</b>	Without function in receiver mode
-------------	-----------------------------------

## AMPT Key

<b>AMPT</b>	
RF ATTEN MANUAL	:INPut<1 2>:ATTenuation <num_value>
PREAMP ON OFF	:INPut<1 2>:GAIN:STATE ON   OFF (with option Preselector- ESPI-B2 only)
10 DB MIN ON OFF	:INPut<1 2>:ATTenuation:PROTection ON   OFF
AUTO RANGE ON OFF	:INPut<1 2>:ATTenuation:AUTO ON   OFF
AUTOPREAMP ON OFF	:INPut<1 2>:GAIN:AUTO ON   OFF (with option Preselector- ESPI-B2 only)
UNIT	
dB $\mu$ V	:CALCulate<1 2>:UNIT:POWer DBUV
dBm	:CALCulate<1 2>:UNIT:POWer DBM
dB $\mu$ A	:CALCulate<1 2>:UNIT:POWer DBUA
dBpW	:CALCulate<1 2>:UNIT:POWer DBPW
dBpT	:CALCulate<1 2>:UNIT:POWer DBPT
GRID RANGE LOG 100 dB	:DISPlay[:WINDow<1 2>]:TRACe<1...3>:Y:SPACing LOGarithmic; :DISPlay[:WINDow<1 2>]:TRACe<1...3>:Y[:SCALe] 100 dB
GRID RANGE LOG MANUAL	:DISPlay[:WINDow<1 2>]:TRACe<1...3>:Y:SPACing LOGarithmic; :DISPlay[:WINDow<1 2>]:TRACe<1...3>:Y[:SCALe] <num_value>
GRID RANGE MIN LEVEL	:DISPlay[:WINDow]:TRACe:Y[:SCALe]:BOTTom <num_value>

**MKR Key**

**MKR**

MARKER  
1..4

```
:CALCulate<1|2>:MARKer<1...4>[:STATe] ON | OFF;
:CALCulate<1|2>:MARKer<1...4>:X <numeric value>;
:CALCulate<1|2>:MARKer<1...4>:Y?
:CALCulate<1|2>:DELTamarker1[:STATe] ON | OFF;
:CALCulate<1|2>:DELTamarker<1...4>:X <numeric value>;
:CALCulate<1|2>:DELTamarker<1...4>:Y?
```

MARKER  
NORM DELTA

```
:CALCulate<1|2>:DELTamarker<1...4>[:STATe] ON | OFF;
```

MKR->  
TRACE

```
:CALCulate<1|2>:MARKer<1...4>:TRACe <num_value>
:CALCulate<1|2>:DELTamarker<1...4>:TRACe <num_value>
```

ALL MARKER  
OFF

```
:CALCulate<1|2>:MARKer<1...4>:AOFF
:CALCulate<1|2>:DELTamarker<1...4>:AOFF
```

## MKR-&gt; Key

MKR->	
SELECT MARKER	No corresponding IEC/IEEE-bus command
PEAK	:CALCulate<1   2>:MARKer<1...4>:MAXimum[:PEAK] :CALCulate<1   2>:DELTamarker<1...4>:MAXimum[:PEAK]
NEXT PEAK	:CALCulate<1   2>:MARKer<1...4>:MAXimum:NEXT :CALCulate<1   2>:DELTamarker<1...4>:MAXimum:NEXT
ADD TO PEAK LIST	--
TUNE TO MARKER	:CALCulate<1   2>:MARKer<1...4>:FUNCTION:CENTer
MARKER TRACK	:CALCulate<1   2>:MARKer<1...4>:COUPled[:STATe] ON   OFF
SEARCH LIMITS	
LEFT LIMIT	:CALCulate<1   2>:MARKer<1...4>:X:SLIMits[:STATe] ON   OFF :CALCulate<1   2>:MARKer<1...4>:X:SLIMits:LEFT <num_value>
RIGHT LIMIT	:CALCulate<1   2>:MARKer<1...4>:X:SLIMits[:STATe] ON   OFF :CALCulate<1   2>:MARKer<1...4>:X:SLIMits:RIGHT <num_value>
THRESHOLD	:CALCulate<1   2>:THReshold[:STATe] ON   OFF :CALCulate<1   2>:THReshold <num_value>
SEARCH LIM OFF	:CALCulate<1   2>:MARKer<1...4>:X:SLIMits[:STATe] OFF :CALCulate<1   2>:THReshold[:STATe] ON   OFF
PEAK EXCURSION	:CALCulate<1   2>:MARKer<1...4>:PEXCursion <num_value>
MKR-> TRACE	:CALCulate<1   2>:MARKer<1...4>:TRACe <numeric value> :CALCulate<1   2>:DELTamarker<1...4>:TRACe <numeric value>
MKR-> CF STEPSIZE	:CALCulate<1   2>:MARKer<1...4>:FUNCTION:CSTep
MIN	:CALCulate<1   2>:MARKer<1...4>:MINimum[:PEAK] :CALCulate<1   2>:DELTamarker<1...4>:MINimum[:PEAK]
MIN NEXT	:CALCulate<1   2>:MARKer<1...4>:MINimum:NEXT :CALCulate<1   2>:DELTamarker<1...4>:MINimum:NEXT
NEXT MODE	-
ABSOLUTE PEAK / MIN	:CALCulate<1   2>:MARKer<1...4>:MAXimum:NEXT :CALCulate<1   2>:DELTamarker<1...4>:MAXimum:NEXT :CALCulate<1   2>:MARKer<1...4>:MINimum:NEXT :CALCulate<1   2>:DELTamarker<1...4>:MINimum:NEXT
SEARCH NEXT LEFT	:CALCulate<1   2>:MARKer<1...4>:MAXimum:LEFT :CALCulate<1   2>:DELTamarker<1...4>:MAXimum:LEFT :CALCulate<1   2>:MARKer<1...4>:MINimum:LEFT :CALCulate<1   2>:DELTamarker<1...4>:MINimum:LEFT
SEARCH NEXT RIGHT	:CALCulate<1   2>:MARKer<1...4>:MAXimum:RIGHT :CALCulate<1   2>:DELTamarker<1...4>:MAXimum:RIGHT :CALCulate<1   2>:MARKer<1...4>:MINimum:RIGHT :CALCulate<1   2>:DELTamarker<1...4>:MINimum:RIGHT
SETTINGS COUPLED	:CALCulate<1   2>:MARKer<1...4>:SCOUPled[:STATe] ON   OFF

## MKR FCTN Key

MKR FUNC	no corresponding IEC/IEEE-bus command
SELECT MARKER	no corresponding IEC/IEEE-bus command
PEAK	:CALCulate<1 2>:MARKer<1...4>:MAXimum[:PEAK] :CALCulate<1 2>:DELTamarker<1...4>:MAXimum[:PEAK]
MARKER ZOOM	:CALCulate<1 2>:MARKer<1...4>:FUNction:ZOOM <num_value>
PREV ZOOM RANGE	--
ZOOM OFF	:CALCulate<1 2>:MARKer<1...4>:FUNction:ZOOM OFF
MKR-> TRACE	:CALCulate<1 2>:MARKer<1...4>:TRACe <numeric value> :CALCulate<1 2>:DELTamarker<1...4>:TRACe <numeric value>

**BW Key**

<b>BW</b>	
RES BW	: [SENSe:]BANDwidth BWIDth:AUTO OFF : [SENSe:]BANDwidth BWIDth[:RESolution] <num_value>
200 Hz	: [SENSe:]BANDwidth BWIDth:AUTO OFF : [SENSe:]BANDwidth BWIDth[:RESolution] 200 HZ
9 kHz	: [SENSe:]BANDwidth BWIDth:AUTO OFF : [SENSe:]BANDwidth BWIDth[:RESolution] 9 KHZ
120 kHz	: [SENSe:]BANDwidth BWIDth:AUTO OFF : [SENSe:]BANDwidth BWIDth[:RESolution] 120 KHZ
1 MHz	: [SENSe:]BANDwidth BWIDth:AUTO OFF : [SENSe:]BANDwidth BWIDth[:RESolution] 1 MHZ
QP RBW UNCOUPLED	: [SENSe:]BANDwidth[:RESolution]:AUTO ON   OFF
FILTER TYPE	: [SENSe:]BANDwidth BWIDth[:RESolution]:TYPE NORMAl   FFT   CFILter   RRC   NOISe   PULSe

**SWEEP Key**

**SWEEP**

USE SCAN  
TABLE

```
:[SENSe:]FREQuency:START <num_value>
:[SENSe:]FREQuency:STOP <num_value>
:[SENSe:]SWEep:SPACing LINear | LOGarithmic | AUTO
:[SENSe<1|2>:]SCAN<1...10>:START <num_value>
:[SENSe<1|2>:]SCAN<1...10>:STOP <num_value>
:[SENSe<1|2>:]SCAN<1...10>:STEP <num_value>
:[SENSe<1|2>:]SCAN<1...10>:BANDwidth:RESolution <num_value>
:[SENSe<1|2>:]SCAN<1...10>:TIME <num_value>
:[SENSe<1|2>:]SCAN<1...10>:INPut:ATTenuation:AUTO ON | OFF
:[SENSe<1|2>:]SCAN<1...10>:INPut:ATTenuation <num_value>
:[SENSe<1|2>:]SCAN<1...10>:INPut:GAIN:AUTO ON | OFF
:DISPlay[:WINDow<1|2>]:TRACe:Y[:SCALE]:BOTTom <num_value>
```

ADJUST  
AXIS

--

INS BEFORE  
RANGE

--

INS AFTER  
RANGE

--

DELETE  
RANGE

--

RANGE  
1-5 6-10

--

USE CURR  
SETTINGS

--

SINGLE  
SCAN

```
:INITiate2:CONTinuous OFF; :INITiate2[:IMMediate]
```

CONTINUOUS  
SCAN

```
:INITiate2:CONTinuous ON; :INITiate2[:IMMediate]
```

FREQ AXIS  
LIN LOG

```
:DISPlay[:WINDow<1|2>]:TRACe:X:SPACing LINear | LOGarithmic
```

RUN SCAN

```
:INITiate2[:IMMediate]
```



## MEAS Key

<b>MEAS</b>	
DETECTOR	--
MAX PEAK	: [SENSe<1 2>:] DETector: RECeiver[: FUNction] POSitive
MIN PEAK	: [SENSe<1 2>:] DETector: RECeiver[: FUNction] NEGative
QUASIPeAK	: [SENSe<1 2>:] DETector: RECeiver[: FUNction] QPeak
AVERAGE	: [SENSe<1 2>:] DETector: RECeiver[: FUNction] AVERage
RMS	: [SENSe<1 2>:] DETector: RECeiver[: FUNction] RMS
QP RBW UNCOUPLED	: [SENSe<1 2>:] BANDwidth[: RESolution]: AUTO ON   OFF
MEAS TIME	: [SENSe<1 2>:] SWEEp: TIME <num_value>
DEMOD	--
DEMOD ON OFF	: [SENSe<1 2>:] DEMod OFF (automatically executed during IEC/IEEE-bus operation switched on with AM FM)
AM	: [SENSe<1 2>:] DEMod AM
FM	: [SENSe<1 2>:] DEMod FM
FINAL MEAS	--
PEAK SEARCH	: CALCulate<1 2>: PEAKsearch PSearch[: IMMEDIATE]
EDIT PEAK LIST	-
EDIT FREQUENCY	--
INSERT	--
DELETE	--
SORT BY FREQUENCY	--
SORT BY DELTA LIM	--
ASCII EXPORT	: FORMat ASCii : MMEMory: STORe: FINal 1, <path with file name>
DECIM SEP . ,	: FORMat: DEXPort: DSEPARATOR POINT COMMA

NO OF PEAKS	:CALCulate<1 2>:PEAKsearch PSEarch:SUBRanges 1 ... 500
PEAKS SUBRANGES	:CALCulate<1 2>:PEAKsearch PSEarch:METHOD SUBRange   PEAK
MARGIN	:CALCulate<1 2>:PEAKsearch PSEarch:MARGIN -200 dB ... 200 dB
FINAL MEAS TIME	:[SENSe<1 2>:]SWEep:TIME:FMEasurement <num_value>
AUTOMATIC FINAL	--
INTER ACTIVE	--
RUN FINAL MEAS	--
ESH2-Z5 ENV 4200	:INPut:LISN[:TYPE] FOURphase
ESHR-Z5	:INPut:LISN[:TYPE] TWOPHase
OFF	:INPut:LISN[:TYPE] OFF
PRESCAN PHASES	See FINAL PHASES
FINAL PHASES	--
PHASE N	:INPut:LISN:PHASe N
PHASE L1	:INPut:LISN:PHASe L1
PHASE L2	:INPut:LISN:PHASe L2
PHASE L3	:INPut:LISN:PHASe L3
PE GROUNDED	:INPut:LISN:PEARth GROunded
PE FLOATING	:INPut:LISN:PEARth FLOating

TRIG Key

TRIG

FREE RUN

:TRIGger[:SEquence]:SOURce IMMEDIATE

EXTERN

:TRIGger[:SEquence]:SOURce EXTERNAL

POLARITY  
POS/NEG

:TRIGger[:SEquence]:SLOPe POSitive | NEGative oder  
:[SENSe:]SWEep:EGATE:POLarity POSitive | NEGative

## TRACE Key

<b>TRACE</b>	
SELECT TRACE	--
CLEAR/ WRITE	:DISPlay[:WINDow<1 2>]:TRACe<1...3>:MODE WRITE
MAX HOLD	:DISPlay[:WINDow<1 2>]:TRACe<1...3>:MODE MAXHold
VIEW	:DISPlay[:WINDow<1 2>]:TRACe<1...3>:MODE VIEW
BLANK	:DISPlay[:WINDow<1 2>]:TRACe<1...3>[:STATE] OFF
SCAN COUNT	: [SENSe:]SWEep:COUNT <num_value> or: : [SENSe:]AVERage:COUNT <num_value>
DETECTOR	--
MAX PEAK	: [SENSe<1 2>:]DETEctor<1...3>[:FUNction] POSitive
MIN PEAK	: [SENSe<1 2>:]DETEctor<1...3>[:FUNction] NEGative
QUASISPEAK	: [SENSe<1 2>:]DETEctor<1...3>[:FUNction] QPEak
AVERAGE	: [SENSe<1 2>:]DETEctor<1...3>[:FUNction] AVERage
RMS	: [SENSe<1 2>:]DETEctor<1...3>[:FUNction] RMS
FINAL MAX PEAK	: [SENSe<1 2>:]DETEctor:FMEasurement POSitive
FINAL MIN PEAK	: [SENSe<1 2>:]DETEctor:FMEasurement NEGative
FINAL QUASISPEAK	: [SENSe<1 2>:]DETEctor:FMEasurement QPEak
FINAL AVERAGE	: [SENSe<1 2>:]DETEctor:FMEasurement AVERage
FINAL RMS	: [SENSe<1 2>:]DETEctor:FMEasurement RMS
PEAK LIST ON OFF	:DISPlay[:WINDow<1 2>]:TRACe<1...3>:SYMBOL CROSSs   OFF
MIN HOLD	:DISPlay[:WINDow<1 2>]:TRACe<1...3>:MODE MINHold
ASCII FILE EXPORT	:FORMat[:DATA] ASCii :MMEMory:STORe<1 2>:TRACe 1,'TRACE.DAT'
DECIM SEP . ,	:FORMat:DEXPort:DSEPARATOR POINT   COMMa
COPY TRACE	:TRACe:COPIY TRACE1 TRACE2 TRACE3,TRACE1 TRACE2 TRACE3

## Signal Analyzer Mode

### FREQUENCY Key

<b>FREQ</b>	
CENTER	: [SENSe:] FREQuency: CENTER <num_value>
CF- SREPSIZE	
0.1 * SPAN	: [SENSe:] FREQuency: CENTER: STEP: LINK SPAN; : [SENSe:] FREQuency: CENTER: STEP: LINK: FACTor 10PCT
0.5 * SPAN	: [SENSe:] FREQuency: CENTER: STEP: LINK SPAN; : [SENSe:] FREQuency: CENTER: STEP: LINK: FACTor 50PCT
X * SPAN	: [SENSe:] FREQuency: CENTER: STEP: LINK SPAN; : [SENSe:] FREQuency: CENTER: STEP: LINK: FACTor <num_value>
0.1 * RBW	: [SENSe:] FREQuency: CENTER: STEP: LINK RBW; : [SENSe:] FREQuency: CENTER: STEP: LINK: FACTor 10PCT
0.5 * RBW	: [SENSe:] FREQuency: CENTER: STEP: LINK RBW; : [SENSe:] FREQuency: CENTER: STEP: LINK: FACTor 50PCT
X * RBW	: [SENSe:] FREQuency: CENTER: STEP: LINK RBW; : [SENSe:] FREQuency: CENTER: STEP: LINK: FACTor <num_value>
= CENTER	no corresponding IEC/IEEE-bus command
= MARKER	no corresponding IEC/IEEE-bus command
MANUAL	: [SENSe:] FREQuency: CENTER: STEP <num_value>
START	: [SENSe:] FREQuency: START <num_value>
STOP	: [SENSe:] FREQuency: STOP <num_value>
FREQUENCY OFFSET	: [SENSe:] FREQuency: OFFSet <num_value>
SIGNAL TRACK	
TRACK ON OFF	: CALCulate<1 2>: MARKer<1...4>: FUNction: STRack[:STATE] ON   OFF
TRACK BW	: CALCulate<1 2>: MARKer<1...4>: FUNction: STRack: BANDwidth <num_value>
TRACK THRESHOLD	: CALCulate<1 2>: MARKer<1...4>: FUNction: STRack: THreshold <num_value>
SELECT TRACE	: CALCulate<1 2>: MARKer<1...4>: FUNction: STRack: TRAcE 1   2   3

**SPAN Key**

<b>SPAN</b>	
SPAN MANUAL	: [SENSe:] FREQuency: SPAN <num_value>
SWEPTIME MANUAL	: [SENSe:] SWEeptime <num_value>
FULL SPAN	: [SENSe:] FREQuency: SPAN: FULL
ZERO SPAN	: [SENSe:] FREQuency: SPAN 0HZ or : [SENSe:] FREQuency: MODE CW   FIXed
LAST SPAN	no corresponding IEC/IEEE-bus command

AMPT Key

<b>AMPT</b>	
REF LEVEL	:DISPlay[:WINDow<1 2>]:TRACe<1...3>:Y[:SCALe]:RLEVEL <num_value>
RANGE LOG 100 dB	:DISPlay[:WINDow<1 2>]:TRACe<1...3>:Y:SPACing LOGarithmic; :DISPlay[:WINDow<1 2>]:TRACe<1...3>:Y[:SCALe] 100 dB
RANGE LOG MANUAL	:DISPlay[:WINDow<1 2>]:TRACe<1...3>:Y:SPACing LOGarithmic; :DISPlay[:WINDow<1 2>]:TRACe<1...3>:Y[:SCALe] <num_value>
RANGE LINEAR	:DISPlay[:WINDow<1 2>]:TRACe<1...3>:Y:SPACing LINear
UNIT	
dBm	:CALCulate<1 2>:UNIT:POWER DBM
dBmV	:CALCulate<1 2>:UNIT:POWER DBMV
dBμV	:CALCulate<1 2>:UNIT:POWER DBUV
dBμA	:CALCulate<1 2>:UNIT:POWER DBUA
dBpW	:CALCulate<1 2>:UNIT:POWER DBPW
VOLT	:CALCulate<1 2>:UNIT:POWER VOLT
AMPERE	:CALCulate<1 2>:UNIT:POWER AMPere
WATT	:CALCulate<1 2>:UNIT:POWER WATT
RF ATTEN MANUAL	:INPut:ATTenuation <num_value>
RF ATTEN AUTO	:INPut:ATTenuation:AUTO ON
REF LEVEL POSITION	:DISPlay[:WINDow<1 2>]:TRACe<1...3>:Y[:SCALe]:RPOSITION <num_value>
REF LEVEL OFFSET	:DISPlay[:WINDow<1 2>]:TRACe<1...3>:Y[:SCALe]:RLEVEL:OFFSet <num_value>
GRID ABS/REL	:DISPlay[:WINDow<1 2>]:TRACe<1...3>:Y[:SCALe]:MODE ABSolute RELative
RF INPUT 50Ω 75Ω	:INPut:IMPedance 50   75

### MKR Key

<b>MKR</b>	
MARKER 1..4	:CALCulate<1 2>:MARKer<1..4>[:STATe] ON   OFF; :CALCulate<1 2>:MARKer<1..4>:X <numeric value>; :CALCulate<1 2>:MARKer<1..4>:Y? :CALCulate<1 2>:DELTamarker1[:STATe] ON   OFF; :CALCulate<1 2>:DELTamarker<1..4>:MODE ABSolute   RELative; :CALCulate<1 2>:DELTamarker<1..4>:X <numeric value>; :CALCulate<1 2>:DELTamarker<1..4>:Y?
MARKER NORM DELTA	:CALCulate<1 2>:DELTamarker<1..4>[:STATe] ON   OFF;
SIGNAL COUNT	:CALCulate<1 2>:MARKer<1..4>:COUNT ON   OFF; :CALCulate<1 2>:MARKer<1..4>:COUNT:FREQuency?
REFERENCE FIXED	
REF FXD ON OFF	:CALCulate<1 2>:DELTamarker<1..4>:FUNctioN:FIXed[:STATe] ON   OFF
REF POINT LEVEL	:CALCulate<1 2>:DELTamarker<1..4>:FUNctioN:FIXed:RPOint:Y <num_value>
REF POINT LVL OFFSET	:CALCulate<1 2>:DELTamarker<1..4>:FUNctioN:FIXed:RPOint:Y:OFFSet <num_value>
REF POINT FREQUENCY	:CALCulate<1 2>:DELTamarker<1..4>:FUNctioN:FIXed:RPOint:X <num_value>
<b>Or:</b>	
REF POINT TIME	:CALCulate<1 2>:DELTamarker<1..4>:FUNctioN:FIXed:RPOint:X <num_value>
PEAK SEARCH	:CALCulate<1 2>:DELTamarker<1..4>:FUNctioN:FIXed:RPOint:MAXimum
MARKER ZOOM	:CALCulate<1 2>:MARKer<1..4>:FUNctioN:ZOOM <num_value>
ALL MARKER OFF	:CALCulate<1 2>:MARKer<1..4>:AOFF :CALCulate<1 2>:DELTamarker<1..4>:AOFF
MKR-> TRACE	:CALCulate<1 2>:MARKer<1..4>:TRACe <num_value> :CALCulate<1 2>:DELTamarker<1..4>:TRACe <num_value>
CNT RESOL ...	:CALCulate<1 2>:MARKer<1..4>:COUNT:RESolution <num_value>



**MKR-> Key**

<b>MKR-&gt;</b>	
SELECT MARKER	No corresponding IEC/IEEE-bus command
PEAK	:CALCulate<1 2>:MARKer<1...4>:MAXimum[:PEAK] :CALCulate<1 2>:DELTamarker<1...4>:MAXimum[:PEAK]
CENTER = MKR FREQ	:CALCulate<1 2>:MARKer<1...4>:FUNction:CENTer
REF LEVEL = MKR LVL	:CALCulate<1 2>:MARKer<1...4>:FUNction:REFerence
NEXT PEAK	:CALCulate<1 2>:MARKer<1...4>:MAXimum:NEXT :CALCulate<1 2>:DELTamarker<1...4>:MAXimum:NEXT
NEXT MODE	
ABSOLUTE PEAK / MIN	:CALCulate<1 2>:MARKer<1...4>:MAXimum:NEXT :CALCulate<1 2>:DELTamarker<1...4>:MAXimum:NEXT :CALCulate<1 2>:MARKer<1...4>:MINimum:NEXT :CALCulate<1 2>:DELTamarker<1...4>:MINimum:NEXT
SEARCH NEXT LEFT	:CALCulate<1 2>:MARKer<1...4>:MAXimum:LEFT :CALCulate<1 2>:DELTamarker<1...4>:MAXimum:LEFT :CALCulate<1 2>:MARKer<1...4>:MINimum:LEFT :CALCulate<1 2>:DELTamarker<1...4>:MINimum:LEFT
SEARCH NEXT RIGHT	:CALCulate<1 2>:MARKer<1...4>:MAXimum:RIGHT :CALCulate<1 2>:DELTamarker<1...4>:MAXimum:RIGHT :CALCulate<1 2>:MARKer<1...4>:MINimum:RIGHT :CALCulate<1 2>:DELTamarker<1...4>:MINimum:RIGHT
SEARCH LIMITS	
LEFT LIMIT	:CALCulate<1 2>:MARKer<1...4>:X:SLIMits[:STATe] ON   OFF :CALCulate<1 2>:MARKer<1...4>:X:SLIMits:LEFT <num_value>
RIGHT LIMIT	:CALCulate<1 2>:MARKer<1...4>:X:SLIMits[:STATe] ON   OFF :CALCulate<1 2>:MARKer<1...4>:X:SLIMits:RIGHT <num_value>
THRESHOLD	:CALCulate<1 2>:THReshold[:STATe] ON   OFF :CALCulate<1 2>:THReshold <num_value>
SEARCH LIM OFF	:CALCulate<1 2>:MARKer<1...4>:X:SLIMits[:STATe] OFF :CALCulate<1 2>:THReshold[:STATe] ON   OFF
PEAK EXCURSION	:CALCulate<1 2>:MARKer<1...4>:PEXCursion <num_value>
MKR-> TRACE	:CALCulate<1 2>:MARKer<1...4>:TRACe <numeric value> :CALCulate<1 2>:DELTamarker<1...4>:TRACe <numeric value>
MKR-> CF STEPSIZE	:CALCulate<1 2>:MARKer<1...4>:FUNction:CSTep
MIN	:CALCulate<1 2>:MARKer<1...4>:MINimum[:PEAK] :CALCulate<1 2>:DELTamarker<1...4>:MINimum[:PEAK]
MIN NEXT	:CALCulate<1 2>:MARKer<1...4>:MINimum:NEXT :CALCulate<1 2>:DELTamarker<1...4>:MINimum:NEXT
NEXT MODE	See above
EXCLUDE LO	:CALCulate<1 2>:MARKer<1...4>:LOEXclude ON   OFF

## MKR FCTN Key

<b>MKR FUNC</b>	
SELECT MARKER	no corresponding IEC/IEEE-bus command
PEAK	:CALCulate<1 2>:MARKer<1...4>:MAXimum[:PEAK] :CALCulate<1 2>:DELTamarker<1...4>:MAXimum[:PEAK]
NOISE MEAS	:CALCulate<1 2>:MARKer<1...4>:FUNCTION:NOISE[:STATE] ON   OFF; :CALCulate<1 2>:MARKer<1...4>:FUNCTION:NOISE:RESult?
PHASE NOISE	
PH NOISE ON OFF	:CALCulate<1 2>:DELTamarker<1...4>:FUNCTION:PNOise[:STATE] ON   OFF :CALCulate<1 2>:DELTamarker<1...4>:FUNCTION:PNOise:RESult?
REF POINT LEVEL	:CALCulate<1 2>:DELTamarker<1...4>:FUNCTION:FIXed:RPOINT:Y <num_value>
REF POINT LVL OFFSET	:CALCulate<1 2>:DELTamarker<1...4>:FUNCTION:FIXed:RPOINT:Y:OFFSet <num_value>
REF POINT FREQUENCY	:CALCulate<1 2>:DELTamarker<1...4>:FUNCTION:FIXed:RPOINT:X <num_value>
PEAK SEARCH	:CALCulate<1 2>:DELTamarker<1...4>:FUNCTION:FIXed:RPOINT:MAXimum
N dB DOWN	:CALCulate<1 2>:MARKer<1...4>:FUNCTION:NDBDown[:STATE] ON   OFF :CALCulate<1 2>:MARKer<1...4>:FUNCTION:NDBDown <num_value> :CALCulate<1 2>:MARKer<1...4>:FUNCTION:NDBDown:RESult? :CALCulate<1 2>:MARKer<1...4>:FUNCTION:NDBDown:FREquency
MARKER DEMODO	
MKR DEMOD ON/OFF	:CALCulate<1 2>:MARKer<1...4>:FUNCTION:DEModulation[:STATE] ON   OFF
AM	:CALCulate<1 2>:MARKer<1...4>:FUNCTION:DEModulation:SELEct AM
FM	:CALCulate<1 2>:MARKer<1...4>:FUNCTION:DEModulation:SELEct FM
MKR STOP TIME	:CALCulate<1 2>:MARKer<1...4>:FUNCTION:DEModulation:HOLDoff <num_value>
CONT DEMOD	:CALCulate<1 2>:MARKer<1...4>:FUNCTION:DEModulation:CONTinuous ON   OFF
MKR-> TRACE	:CALCulate<1 2>:MARKer<1...4>:TRACe <numeric value> :CALCulate<1 2>:DELTamarker<1...4>:TRACe <numeric value>

**BW Key**

<b>BW</b>	
RES BW MANUAL	: [SENSe:]BANDwidth BWIDth:AUTO OFF :[SENSe:]BANDwidth BWIDth[:RESolution] <num_value>
VIDEO BW MANUAL	: [SENSe:]BANDwidth BWIDth:VIDeo:AUTO OFF :[SENSe:]BANDwidth BWIDth:VIDeo <num_value>
SWEEP TIME MANUAL	: [SENSe:]SWEep:TIME:AUTO OFF :[SENSe:]SWEep:TIME <num_value>
RES BW AUTO	: [SENSe:]BANDwidth BWIDth[:RESolution]:AUTO ON
VIDEO BW AUTO	: [SENSe:]BANDwidth BWIDth:VIDeo:AUTO ON
SWEEP TIME AUTO	: [SENSe:]SWEep:TIME:AUTO ON
COUPLING RATIO	--
RBW / VBW SINE [1/3]	: [SENSe:]BANDwidth BWIDth:VIDeo:RATIo 3
RBW / VBW PULSE [.1]	: [SENSe:]BANDwidth BWIDth:VIDeo:RATIo 10
RBW / VBW NOISE [10]	: [SENSe:]BANDwidth BWIDth:VIDeo:RATIo 0.1
RBW / VBW MANUAL	: [SENSe:]BANDwidth BWIDth:VIDeo:RATIo <num_value>
SPAN / RBW AUTO [50]	: [SENSe:]BANDwidth BWIDth[:RESolution]:RATIo 0.02
SPAN / RBW MANUAL	: [SENSe:]BANDwidth BWIDth[:RESolution]:RATIo <num_value>
COUPLING DEFAULT	: [SENSe:]BANDwidth BWIDth[:RESolution]:AUTO ON; :[SENSe:]BANDwidth BWIDth:VIDeo:AUTO ON; :[SENSe:]SWEep:TIME:AUTO ON
FILTER TYPE	: [SENSe:]BANDwidth BWIDth[:RESolution]:TYPE NORMAL   FFT   CFILter   RRC
VBW MODE LIN LOG	: [SENSe:]BANDwidth BWIDth:VIDeo:TYPE LINear   LOGarithmic

**SWEEP Key**

<b>SWEEP</b>	
CONTINUOUS SWEEP	:INITiate:CONTinuous ON
SINGLE SWEEP	:INITiate:CONTinuous OFF; :INITiate:IMMediate
CONTINUE SGL SWEEP	:INITiate:CONMeasure
SWEEP TIME MANUAL	:[SENSe:]SWEep:TIME <num_value>
SWEEP TIME AUTO	:[SENSe:]SWEep:TIME:AUTO ON   OFF
SWEEP COUNT	:[SENSe:]SWEep:COUNT <num_value>
SGL SWEEP DISP OFF	:INITiate:DISPlay OFF :INITiate:IMMediate

MEAS Key

<b>MEAS</b>	
TIME DOM POWER	:CALCulate<1 2>:MARKer<1...4>:FUNCTION:SUMMARY:RMS[:STATE] ON :CALCulate<1 2>:MARKer<1...4>:FUNCTION:SUMMARY:PPEak[:STATE] ON :CALCulate<1 2>:MARKer<1...4>:FUNCTION:SUMMARY:MEAN[:STATE] ON :CALCulate<1 2>:MARKer<1...4>:FUNCTION:SUMMARY:SDEVIation[:STATE] ON
POWER ON OFF	:CALCulate<1 2>:MARKer<1...4>:FUNCTION:SUMMARY:RMS[:STATE] ON OFF :CALCulate<1 2>:MARKer<1...4>:FUNCTION:SUMMARY:PPEak[:STATE] ON OFF :CALCulate<1 2>:MARKer<1...4>:FUNCTION:SUMMARY:MEAN[:STATE] ON OFF :CALCulate<1 2>:MARKer<1...4>:FUNCTION:SUMMARY:SDEVIation[:STATE] ON OFF
RMS	:CALCulate<1 2>:MARKer<1...4>:FUNCTION:SUMMARY:RMS[:STATE] ON   OFF :CALCulate<1 2>:MARKer<1...4>:FUNCTION:SUMMARY:RMS:RESult?
PEAK	:CALCulate<1 2>:MARKer<1...4>:FUNCTION:SUMMARY:PPEak[:STATE] ON   OFF :CALCulate<1 2>:MARKer<1...4>:FUNCTION:SUMMARY:PPEak:RESult?
MEAN	:CALCulate<1 2>:MARKer<1...4>:FUNCTION:SUMMARY:MEAN[:STATE] ON   OFF :CALCulate<1 2>:MARKer<1...4>:FUNCTION:SUMMARY:MEAN:RESult?
STANDARD DEVIATION	:CALCulate<1 2>:MARKer<1...4>:FUNCTION:SUMMARY:SDEVIation[:STATE] ON OFF :CALCulate<1 2>:MARKer<1...4>:FUNCTION:SUMMARY:SDEVIation:RESult?
LIMITS ON OFF	:CALCulate<1 2>:MARKer<1...4>:SLIMITs ON   OFF
START LIMIT	:CALCulate<1 2>:MARKer<1...4>:SLIMITs:LEFT <num_value>
STOP LIMIT	:CALCulate<1 2>:MARKer<1...4>:SLIMITs:RIGHT <num_value>
SET REFERENCE	:CALCulate<1 2>:MARKer<1...4>:FUNCTION:SUMMARY:REFerence:AUTO ONCE
POWER ABS REL	:CALCulate<1 2>:MARKer<1...4>:FUNCTION:SUMMARY:MODE ABS   REL
MAX HOLD ON OFF	:CALCulate<1 2>:MARKer<1...4>:FUNCTION:SUMMARY:PHOLd ON   OFF :CALCulate<1 2>:MARKer<1...4>:FUNCTION:SUMMARY:PPEak:PHOLd:RESult? :CALCulate<1 2>:MARKer<1...4>:FUNCTION:SUMMARY:RMS:PHOLd:RESult? :CALCulate<1 2>:MARKer<1...4>:FUNCTION:SUMMARY:MEAN:PHOLd:RESult? :CALCulate<1 2>:MARKer<1...4>:FUNCTION:SUMMARY:SDEVIation:PHOLd:RESult?
AVERAGE ON OFF	:CALCulate<1 2>:MARKer<1...4>:FUNCTION:SUMMARY:AVERAge ON   OFF :CALCulate<1 2>:MARKer<1...4>:FUNCTION:SUMMARY:PPEak:AVERAge:RESult? :CALCulate<1 2>:MARKer<1...4>:FUNCTION:SUMMARY:RMS:AVERAge:RESult? :CALCulate<1 2>:MARKer<1...4>:FUNCTION:SUMMARY:MEAN:AVERAge:RESult? :CALCulate<1 2>:MARKer<1...4>:FUNCTION:SUMMARY:SDEVIation:AVERAge:RES?
NUMBER OF SWEEPS	:[SENSe:]SWEep:COUNT <num_value>
CHAN PWR ACP	--
CP / ACP ON OFF	:CALCulate<1 2>:MARKer<1...4>:FUNCTION:POWER:SElect CPower   ACPower; :CALCulate<1 2>:MARKer<1...4>:FUNCTION:POWER:RESult? CPower   ACPower; :CALCulate<1 2>:MARKer<1...4>:FUNCTION:POWER[:STATE] OFF
CP / ACP STANDARD	:CALCulate<1 2>:MARKer<1...4>:FUNCTION:POWER:PRESet <standard>
CP / ACP CONFIG	--
NO. OF ADJ CHAN	: [SENSe:]POWER:ACHannel:ACPairs <num_value>
CHANNEL BANDWIDTH	: [SENSe:]POWER:ACHannel:BANDwidth BWIDth[:CHANnel] <num_value>



SIGNAL STATISTIC	
APD ON OFF	:CALCulate:STATistics:APD[:STATE] ON   OFF :CALCulate:STATistics:RESult<1...3>? MEAN   PEAK   CFACtor   ALL
CCDF ON OFF	:CALCulate:STATistics:CCDF[:STATE] ON   OFF :CALCulate:STATistics:RESult<1...3>? MEAN   PEAK   CFACtor   ALL
PERCENT MARKER	:CALCulate:MARKer<1..4>:Y:PERCentage 0...100%
RES BW	:[SENSe:]BANDwidth[:RESolution]:AUTO OFF :[SENSe:]BANDwidth[:RESolution] <num_value>
NO OF SAMPLES	:CALCulate:STATistics:NSAMples <num_value>
SCALING	--
X-AXIS REF LEVEL	:CALCulate:STATistics:X:RLEVel <num_value>
X-AXIS RANGE	:CALCulate:STATistics:X:RANGE <num_value>
Y-AXIS MAX VALUE	:CALCulate:STATistics:Y:UPPER <num_value>
Y-AXIS MIN VALUE	:CALCulate:STATistics:Y:LOWer <num_value>
ADJUST SETTINGS	:CALCulate:STATistics:SCALE:AUTO ONCE
DEFAULT SETTINGS	:CALCulate:STATistics:PRESet
ADJUST SETTINGS	:CALCulate:STATistics:SCALE:AUTO ONCE
SINGLE MEAS	:INITiate:CONTinuous OFF; :INITiate:IMMediate
COUNT MEAS	:INITiate:CONTinuous ON; :INITiate:IMMediate
C/N C/No	
C/N	:CALCulate<1 2>:MARKer:FUNCTion:POWer:SElect CN :CALCulate<1 2>:MARKer:FUNCTion:POWer:RESult? CN :CALCulate<1 2>:MARKer:FUNCTion:POWer OFF
C/No	:CALCulate<1 2>:MARKer:FUNCTion:POWer:SElect CNO :CALCulate<1 2>:MARKer:FUNCTion:POWer:RESult? CNO :CALCulate<1 2>:MARKer:FUNCTion:POWer OFF
CHANNEL BANDWIDTH	:[SENSe<1 2>:]POWer:ACHannel:BWIDth[:CHANnel] 14kHz
ADJUST SETTINGS	:[SENSe<1 2>:]POWer:ACHannel:PRESet CN   CNO
MODULATION DEPTH	:CALCulate<1 2>:MARKer<1...4>:FUNCTion:MDEPth[:STATE] ON   OFF :CALCulate<1 2>:MARKer<1...4>:FUNCTion:MDEPth:RESult?
TOI	:CALCulate<1 2>:MARKer<1...4>:FUNCTion:TOI[:STATE] ON   OFF :CALCulate<1 2>:MARKer<1...4>:FUNCTion:TOI:RESult?
SELECT MARKER	no corresponding IEC/IEEE-bus command

TRIG Key

<b>TRIG</b>	
FREE RUN	:TRIGger[:SEquence]:SOURce IMMEDIATE
VIDEO	:TRIGger[:SEquence]:SOURce VIDEO :TRIGger[:SEquence]:LEVel:VIDeo <numeric value>
EXTERN	:TRIGger[:SEquence]:SOURce EXTERNAL :[SENSe:]SWEep:EGATE:SOURce EXTERNAL
IF POWER	:TRIGger[:SEquence]:SOURce IFPower :[SENSe:]SWEep:EGATE:SOURce IFPower
RF POWER	:TRIGger[:SEquence]:SOURce RFPower :[SENSe:]SWEep:EGATE:SOURce RFPower (only with option FSP-B6)
TRIGGER OFFSET	:TRIGger[:SEquence]:HOLDoff <num_value>
POLARITY POS/NEG	:TRIGger[:SEquence]:SLOPe POSitive   NEGative :[SENSe:]SWEep:EGATE:POLarity POSitive   NEGative
GATED TRIGGER	: [SENSe:]SWEep:EGATE ON   OFF :[SENSe:]SWEep:EGATE:SOURce IFPower   EXTERNAL
GATE SETTINGS	--
GATE MODE LEVEL/EDGE	: [SENSe:]SWEep:EGATE:TYPE LEVel   EDGE
POLARITY POS/NEG	: [SENSe:]SWEep:EGATE:POLarity POSitive   NEGative
GATE DELAY	: [SENSe:]SWEep:EGATE:HOLDoff <num_value>
GATE LENGTH	: [SENSe:]SWEep:EGATE:LENGth <num_value>
SWEEP TIME	--
PRINT SCREEN	--
TV TRIG SETTINGS	:TRIGger[:SEquence]:SOURce TV (only with option FSP-B6)
TV TRIGGER ON OFF	: [SENSe:]TV[:STATe] ON   OFF
VERT SYNC	:TRIGger[:SEquence]:VIDeo:FIELD:SElect ALL
VERT SYNC ODD FIELD	:TRIGger[:SEquence]:VIDeo:FIELD:SElect ODD
VERT SYNC EVEN FIELD	:TRIGger[:SEquence]:VIDeo:FIELD:SElect EVEN
HOR SYNC	:TRIGger[:SEquence]:VIDeo:LINE:NUMBer <num_value>
VIDEO POL POS NEG	:TRIGger[:SEquence]:VIDeo:SSIGNAL:POLarity NEGative   POSitive
LINE 625 525	:TRIGger[:SEquence]:VIDeo:FORMat:LPFrame 525   625
CCVS INT EXT	: [SENSe:]TV:CCVS INT   EXT



## TRACE Key

<b>TRACE</b>	
SELECT TRACE	--
CLEAR/ WRITE	:DISPlay[:WINDow<1 2>]:TRACe<1...3>:MODE WRITe
MAX HOLD	:DISPlay[:WINDow<1 2>]:TRACe<1...3>:MODE MAXHold
AVERAGE	:DISPlay[:WINDow<1 2>]:TRACe<1...3>:MODE AVERAge or: :[SENSe:]AVERAge[:STATe<1...3>] ON
VIEW	:DISPlay[:WINDow<1 2>]:TRACe<1...3>:MODE VIEW
BLANK	:DISPlay[:WINDow<1 2>]:TRACe<1...3>[:STATe] OFF
SWEEP COUNT	:[SENSe:]SWEep:COUNT <num_value> or: :[SENSe:]AVERAge:COUNT <num_value>
DETECTOR	--
AUTO SELECT	:[SENSe:]DETEctor[:FUNCTion]:AUTO ON   OFF
DETECTOR AUTOPEAK	:[SENSe:]DETEctor[:FUNCTion] APEak
DETECTOR MAX PEAK	:[SENSe:]DETEctor[:FUNCTion] POSitive
DETECTOR MIN PEAK	:[SENSe:]DETEctor[:FUNCTion] NEGative
DETECTOR SAMPLE	:[SENSe:]DETEctor[:FUNCTion] SAMPlE
DETECTOR RMS	:[SENSe:]DETEctor[:FUNCTion] RMS
DETECTOR AVERAGE	:[SENSe:]DETEctor[:FUNCTion] AVERAge
DETECTOR QPK	:[SENSe:]DETEctor[:FUNCTion] QPEak
TRACE MATH	--
T1-T2->T1	:CALCulate<1 2>:MATH:STATe ON :CALCulate<1 2>:MATH[:EXPRession][:DEFine] (TRACE1 - TRACE2)
T1-T3->T1	:CALCulate<1 2>:MATH:STATe ON :CALCulate<1 2>:MATH[:EXPRession][:DEFine] (TRACE1 - TRACE3)
TRACE POSITION	:CALCulate<1 2>:MATH:POSition <num_value>
TRACE MATH OFF	:CALCulate<1 2>:MATH:STATe OFF

MIN HOLD	:DISPlay[:WINDow<1 2>]:TRACe<1...3>:MODE MINHold
AVG MODE LOG LIN	:CALCulate<1 2>:MATH:MODE LINear   LOGarithmic or: :[SENSe:]AVERAge:TYPE VIDEo   LINear
ASCII FILE EXPORT	:FORMat[:DATA] ASCii :MMEMory:STORe<1 2>:TRACe 1,'TRACE.DAT'
DECIM SEP . ,	:FORMat:DEXPort:DSEParator POINT   COMMa
COPY TRACE	:TRACe:COPIY TRACE1 TRACE2 TRACE3,TRACE1 TRACE2 TRACE3

# General Settings

## LINES Key

LINES	<p>Selection:</p> <pre>:CALCulate&lt;1 2&gt;:LIMit&lt;1...8&gt;:NAME &lt;string&gt;; :CALCulate&lt;1 2&gt;:LIMit&lt;1...8&gt;:UPPer:STATE ON   OFF :CALCulate&lt;1 2&gt;:LIMit&lt;1...8&gt;:LOWer:STATE ON   OFF</pre> <p>Limit check: (only analyzer mode)</p> <pre>:CALCulate&lt;1 2&gt;:LIMit&lt;1...8&gt;:STATE ON   OFF :INITiate[:IMMediate]; WAI* :CALCulate&lt;1 2&gt;:LIMit&lt;1...8&gt;:FAIL?</pre> <p>Trace assignment:</p> <pre>:CALCulate&lt;1 2&gt;:LIMit&lt;1...8&gt;:TRACe 1 2 3</pre>
SELECT LIMIT LINE	
NEW LIMIT LINE	
NAME	<p>Name: :CALCulate&lt;1 2&gt;:LIMit&lt;1...8&gt;:NAME &lt;string&gt;;</p> <p>Domain: (receiver mode: FREQUency only)</p> <pre>:CALCulate&lt;1 2&gt;:LIMit&lt;1...8&gt;:CONTRol:DOMain FREQUency TIME</pre> <p>Interpolation:</p> <pre>:CALCulate&lt;1 2&gt;:LIMit&lt;1...8&gt;:CONTRol:SPACing LIN   LOG :CALCulate&lt;1 2&gt;:LIMit&lt;1...8&gt;:UPPer:SPACing LIN   LOG :CALCulate&lt;1 2&gt;:LIMit&lt;1...8&gt;:LOWer:SPACing LIN   LOG</pre> <p>Scaling: (receiver mode: ABSolute only)</p> <pre>:CALCulate&lt;1 2&gt;:LIMit&lt;1...8&gt;:CONTRol:MODE RELative   ABSolute :CALCulate&lt;1 2&gt;:LIMit&lt;1...8&gt;:UPPer:MODE RELative   ABSolute :CALCulate&lt;1 2&gt;:LIMit&lt;1...8&gt;:LOWer:MODE RELative   ABSolute</pre> <p>Unit:</p> <pre>:CALCulate&lt;1 2&gt;:LIMit&lt;1...8&gt;:UNIT DBM   DBPW   WATT   DBUV   DBMV   VOLT   DBUA   AMPere   DB   DBT   DBUV_M   DBUA_M   DBUV_MHZ   DBMV_MHZ   DBUA_MHZ   DBUV_MMHZ   DBUA_MMHZ</pre> <p>Margin: :CALCulate&lt;1 2&gt;:LIMit&lt;1...8&gt;:UPPer:MARGIN &lt;num_value&gt;</p> <pre>:CALCulate&lt;1 2&gt;:LIMit&lt;1...8&gt;:LOWer:MARGIN &lt;num_value&gt;</pre> <p>Threshold value for relative y scaling (only analyzer mode)</p> <pre>:CALCulate&lt;1 2&gt;:LIMit&lt;1...8&gt;:UPPer:THReshold &lt;num_value&gt; :CALCulate&lt;1 2&gt;:LIMit&lt;1...8&gt;:LOWer:THReshold &lt;num_value&gt;</pre> <p>Comment:</p> <pre>:CALCulate&lt;1 2&gt;:LIMit&lt;1...8&gt;:COMMENT &lt;string&gt;</pre>
VALUES	<pre>:CALCulate&lt;1 2&gt;:LIMit&lt;1...8&gt;:CONTRol[:DATA] &lt;num_value&gt;, &lt;num_value&gt;.. :CALCulate&lt;1 2&gt;:LIMit&lt;1...8&gt;:UPPer[:DATA] &lt;num_value&gt;, &lt;num_value&gt;.. :CALCulate&lt;1 2&gt;:LIMit&lt;1...8&gt;:LOWer[:DATA] &lt;num_value&gt;, &lt;num_value&gt;..</pre>
INSERT VALUE	no corresponding IEC/IEEE-bus command
DELETE VALUE	no corresponding IEC/IEEE-bus command
SHIFT X LIMIT LINE	:CALCulate<1 2>:LIMit<1...8>:CONTRol:SHIFt <num_value>
SHIFT Y LIMIT LINE	<pre>:CALCulate&lt;1 2&gt;:LIMit&lt;1...8&gt;:UPPer:SHIFt &lt;num_value&gt; :CALCulate&lt;1 2&gt;:LIMit&lt;1...8&gt;:LOWer:SHIFt &lt;num_value&gt;</pre>
SAVE LIMIT LINE	automatically executed during IEC/IEEE-bus operation
EDIT LIMIT LINE	s. EDIT LIMIT LINE
COPY LIMIT LINE	:CALCulate<1 2>:LIMit<1...8>:COPY 1...8   <name>

DELETE LIMIT LINE	:CALCulate<1 2>:LIMit<1...8>:DELeTe
X OFFSET	:CALCulate<1 2>:LIMit<1...8>:CONTRol:OFFset <num_value>
Y OFFSET	:CALCulate<1 2>:LIMit<1...8>:UPPer:OFFset <num_value> :CALCulate<1 2>:LIMit<1...8>:LOWer:OFFset <num_value>
DISPLAY LINES	
DISPLAY LINE 1/2	:CALCulate<1 2>:DLINe<1 2>:STATe ON   OFF; :CALCulate<1 2>:DLINe<1 2> <numeric_value>
FREQUENCY LINE 1/2	:CALCulate<1 2>:FLINe<1 2>:STATe ON   OFF; :CALCulate<1 2>:FLINe<1 2> <numeric_value>
TIME LINE 1/2	:CALCulate<1 2>:TLINe<1 2>:STATe ON   OFF; :CALCulate<1 2>:TLINe<1 2> <numeric_value>

**DISP Key**

<b>DISP</b>	
FULL SCREEN	:DISPlay:FORMat SINGLE :DISPlay[:WINDow<1 2>]:SElect
SPLIT SCREEN	DISPlay:FORMat SPLit
REF LEVEL COUPLED	:INSTRument:COUPle RLEVel   NONE (analyzer mode only)
CENTER B = MARKER A	:INSTRument:COUPle CF_B   NONE (analyzer mode only)
CENTER A = MARKER B	:INSTRument:COUPle CF_A   NONE (analyzer mode only)
CONFIG DISPLAY	--
SCREEN TITLE	:DISPlay[:WINDow<1 2>]:TEXT[:DATA] <string> :DISPlay[:WINDow<1 2>]:TEXT:STATE ON   OFF
TIME/DATE ON OFF	:DISPlay[:WINDow<1 2>]:TIME ON   OFF
LOGO ON/OFF	:DISPlay:LOGO ON OFF
ANNOTATION ON/OFF	:DISPlay:ANNotation:FREQuency ON OFF
DATAENTRY OPAQUE	no corresponding IEC/IEEE-bus command
DEFAULT COLORS 1	:DISPlay:CMAP<1...32>:DEFault1
DEFAULT COLORS 2	:DISPlay:CMAP<1...32>:DEFault2
DISPLAY PWR SAVE	:DISPlay:PSAVe[:STATE] ON   OFF :DISPlay:PSAVe:HOLDoff <num_value>
SELECT OBJECT	--
BRIGHTNESS	:DISPlay:CMAP:HSL <hue>,<sat>,<lum>
TINT	:DISPlay:CMAP<1...32>:HSL <hue>,<sat>,<lum>
SATURATION	:DISPlay:CMAP<1...32>:HSL <hue>,<sat>,<lum>
PREDEFINED COLORS	:DISPlay:CMAP<1...32>:PDEfined BLACK  BLUE  BROWn  GREen  CYAN  RED  MAGenta  YELLow  WHITE  DGRAY  LGRAY  LBLUE  LGREen  LcYan  LRED  MAGenta

**FILE Key**

<b>FILE</b>	
SAVE	:MMEemory:STORe:STATe 1,<file_name>
RECALL	:MMEemory:LOAD:STATe 1,<file_name>
EDIT COMMENT	:MMEemory:COMMeNt <string>
ITEMS TO SAVE/RCL	
SELECT ITEMS	:MMEemory:SElect[:ITEM]:HWSettings ON OFF :MMEemory:SElect[:ITEM]:TRACe[:ACTive] ON OFF :MMEemory:SElect[:ITEM]:LINEs:ALL ON OFF :MMEemory:SElect[:ITEM]:FINAl ON OFF :MMEemory:SElect[:ITEM]:SCData ON OFF :MMEemory:SElect[:ITEM]:TRANSDucer ON OFF :MMEemory:SElect[:ITEM]:TRANSDucer:ALL ON OFF :MMEemory:SElect[:ITEM]:NONE
DEFAULT CONFIG	:MMEemory:SElect[:ITEM]:DEFault
DISABLE ALL ITEMS	:MMEemory:SElect[:ITEM]:NONE
ENABLE ALL ITEMS	:MMEemory:SElect[:ITEM]:ALL
DATA SET LIST	--
DATA SET CLEAR	:MMEemory:CLEAr:STATe 1,<file_name>
DATA SET CLEAR ALL	:MMEemory:CLEAr:ALL
STARTUP RECALL	:MMEemory:LOAD:AUTO 1,<file_name>
FILE MANAGER	
EDIT PATH	:MMEemory:MSIS <device> :MMEemory:CDIRectory <directory_name>
MAKE DIRECTORY	:MMEemory:MDIRectory <directory_name>
FORMAT DISK	:MMEemory:INITialize <msus>
RENAME	:MMEemory:MOVE <file_source>,<file_destination>
SORT MODE	no corresponding IEC/IEEE-bus command
COPY	:MMEemory:COpy <file_source>,<file_destination>
DELETE	:MMEemory:DELeTe <file_name> :MMEemory:RDIRectory <directory_name>

### CAL Key

<b>CAL</b>	
CAL TOTAL	:CALibration[:ALL]?
CAL ABORT	:CALibration:ABORt
CAL CORR ON OFF	:CALibration:STAtE ON   OFF
CAL RESULTS	:CALibration:RESuLts?

**SETUP Key**

REFERENCE INT/EXT	:[SENSe:]ROSCillator:SOURce INTernal EXTernal
NOISE SCR ON OFF	::DIAGnostic:SERvice:NSource ON   OFF <num_value>
PREAMP ON OFF	:INPut<1 2>:GAIN:STATE ON   OFF (with option Preselector- ESPI-B2 only)
PRESELECT ON OFF	:INPut<1 2>:PRESelection[:STATE] ON   OFF (with option Preselector- ESPI-B2 only) The softkey is only available in analyzer mode
TRANSDUCER	--

TRANSDUCER FACTOR	:[SENSe<1 2>:]CORRection:TRANsducer:SElect <name> :[SENSe<1 2>:]CORRection:TRANsducer[:STATE] ON   OFF
----------------------	---

TRANSDUCER SET	:[SENSe<1 2>:]CORRection:TSET:SElect <name> :[SENSe<1 2>:]CORRection:TSET[:STATE] ON   OFF
-------------------	---

NEW	
-----	--

**Transducer Factor**

: [SENSe<1|2>:]CORRection:TRANsducer:SCALing LINear|LOGarithmic  
: [SENSe<1|2>:]CORRection:TRANsducer:COMMENT <string>

TRD FACTOR NAME	:[SENSe<1 2>:]CORRection:TRANsducer:SElect <name>
--------------------	---

TRD FACTOR UNIT	:[SENSe<1 2>:]CORRection:TRANsducer:UNIT <string>
--------------------	---

TRD FACTOR VALUES	:[SENSe<1 2>:]CORRection:TRANsducer:DATA <freq>,<level>..
----------------------	---

INSERT LINE	no corresponding IEC/IEEE-bus command
----------------	---------------------------------------

DELETE LINE	no corresponding IEC/IEEE-bus command
----------------	---------------------------------------

SAVE TRD FACTOR	automatically executed during IEC/IEEE-bus operation
--------------------	--

**Transducer Set**

: [SENSe<1|2>:]CORRection:TSET:BREak ON | OFF  
: [SENSe<1|2>:]CORRection:TSET:COMMENT <string>  
: [SENSe<1|2>:]CORRection:TSET:SElect <name>  
: [SENSe<1|2>:]CORRection:TSET:UNIT <string>  
: [SENSe<1|2>:]CORRection:TSET:RANGE<1...10> <freq>,<freq1>,<name>..

INS BEFORE RANGE	no corresponding IEC/IEEE-bus command
---------------------	---------------------------------------

INS AFTER RANGE	no corresponding IEC/IEEE-bus command
--------------------	---------------------------------------

DELETE RANGE	no corresponding IEC/IEEE-bus command
-----------------	---------------------------------------

RANGES 1-5 6-10	no corresponding IEC/IEEE-bus command
--------------------	---------------------------------------

SAVE TRD SET	automatically executed during IEC/IEEE-bus operation
-----------------	--



EDIT	see NEW
DELETE	:[SENSe<1 2>:]CORRection:TRANsducer:DELeTe :[SENSe<1 2>:]CORRection:TSET:DELeTe
VIEW TRANSDUCER	no corresponding IEC/IEEE-bus command
GENERAL SETUP	--
GPIB ADDRESS	:SYSTem:COMMunicate:GPIB[:SELF]:ADDRess 0...30
USER PORT	
USER PORT IN OUT	:INPut:UPOrt:STATe ON   OFF :INPut:UPOrt[:VALue]
PORT X 0 1	:OUTPut:UPOrt:STATe ON   OFF :OUTPut:UPOrt[:VALue] <Binary>
COM INTERFACE	:SYSTem:COMMunicate:SERial[:RECeive:]BAUD <num_value> :SYSTem:COMMunicate:SERial[:RECeive:]BITS 7   8 :SYSTem:COMMunicate:SERial:RECeive:PARity[:TYPE] EVEN   ODD   NONE :SYSTem:COMMunicate:SERial[:RECeive:]SBITS 1 2 :SYSTem:COMMunicate:SERial:CONTRol:DTR IBFull   OFF :SYSTem:COMMunicate:SERial:CONTRol:RTS IBFull   OFF :SYSTem:COMMunicate:SERial[:RECeive]:PACE XON   NONE
TIME+DATE	:SYSTem:TIME 0...23, 0...59, 0...59 :SYSTem:DATE <num>, <num>, <num>
CONFIGURE NETWORK	Only with option LANinterface FSP-B16 --
NETWORK LOGIN	Only with option LAN interface FSP-B16 --
SOFT FRONT PANEL	--
SYSTEM INFO	--
HARDWARE INFO	--
STATISTICS	--
SYSTEM MESSAGES	:SYSTem:ERRor?
CLEAR ALL MESSAGES	:SYSTem:ERRor?
SERVICE	--
INPUT RF	:DIAGnostic:SERvice:INPut[:SELeCt] RF
INPUT CAL	:DIAGnostic:SERvice:INPut[:SELeCt] :CALibration :DIAGnostic:SERvice:CSORce[:POWer] <num_value>
SELFTTEST	*TST?

SELFTEST RESULTS	:DIAGnostic:SERvice:STEst:REsult?
REFERENCE FREQUENCY	[SENSE<1 2>:]ROSCillator[:INTernal]:TUNe 0...4095
CAL SIGNAL POWER	--
SAVE CHANGES	[SENSE<1 2>:]ROSCillator[:INTernal]:TUNe:SAVe
ENTER PASSWORD	:SYSTem:PASSword[:CENable] <string>
CAL GEN 128 MHz	:DIAGnostic:SERvice:INPut[:SElect] :CALibration :DIAGnostic:SERvice:INPut:PULSed[:STATe] OFF
PULSE XXX	:DIAGnostic:SERvice:INPut[:SElect] :CALibration :DIAGnostic:SERvice:INPut:PULSed[:STATe] ON :DIAGnostic:SERvice:INPut:PULSed:PRATe 10 kHz   100 kHz   200 kHz   500 kHz   1 MHz   2 MHz   4 MHz   6 MHz
FIRMWARE UPDATE	--
RESTORE FIRMWARE	--

## HCOPY Key

<b>HCOPY</b>	
PRINT SCREEN	:HCOPY:ITEM:ALL :HCOPY:IMMEDIATE  for printout into file add :MMEMORY:NAME <file_name>
PRINT TRACE	:HCOPY:ITEM:WINDOW<1 2>:TRACE:STATE ON   OFF :HCOPY:IMMEDIATE  for printout into file add :MMEMORY:NAME <file_name>
PRINT TABLE	:HCOPY:ITEM:WINDOW<1 2>:TABLE:STATE ON   OFF :HCOPY:IMMEDIATE  for printout into file add :MMEMORY:NAME <file_name>
HARDCOPY ABORT	:HCOPY:ABORT
DEVICE1	:SYSTEM:COMMUNICATE:PRINTER:ENUMERATE:FIRST? :SYSTEM:COMMUNICATE:PRINTER:ENUMERATE:NEXT? :SYSTEM:COMMUNICATE:PRINTER:SELECT <string> :HCOPY:DESTINATION <string> :HCOPY:DEVICE:LANGUAGE GDI   WMF   EWMF   BMP :HCOPY:PAGE:ORIENTATION<1 2> LANDSCAPE   PORTRAIT
DEVICE2	:SYSTEM:COMMUNICATE:PRINTER:ENUMERATE:FIRST? :SYSTEM:COMMUNICATE:PRINTER:ENUMERATE:NEXT? :SYSTEM:COMMUNICATE:PRINTER:SELECT "string" :HCOPY:DESTINATION2 <string> :HCOPY:DEVICE:LANGUAGE GDI   WMF   EWMF   BMP :HCOPY:PAGE:ORIENTATION<1 2> LANDSCAPE   PORTRAIT
COLORS	--
COLOR ON/OFF	:HCOPY:DEVICE:COLOR ON   OFF
SCREEN COLORS	:HCOPY:CMAP:DEF1
OPTIMIZED COLORS	:HCOPY:CMAP:DEF2
USER DEFINED	:HCOPY:CMAP:DEF3
SELECT OBJECT	- print element is selected via suffix in CMAP
BRIGHTNESS	:HCOPY:CMAP<1...32>:HSL <hue>, <sat>, <lum>
TINT	:HCOPY:CMAP<1...32>:HSL <hue>, <sat>, <lum>
SATURATION	:HCOPY:CMAP<1...32>:HSL <hue>, <sat>, <lum>
PREDEFINED COLORS	:HCOPY:CMAP<1...32>:PDEF BLACK   BLUE   BROWN   GREEN   CYAN   RED   MAGENTA   YELLOW   WHITE   DGRAY   LGRAY   LBLUE   LGREEN   LCYAN   LRED   LMAGENTA
SET TO DEFAULT	--
COMMENT SCREEN A/B	:HCOPY:ITEM:WINDOW<1 2>:TEXT <string>
INSTALL PRINTER	

## Hotkeys

SPECTRUM	<pre>:INSTRument[:SElect] SANalyzer :INSTRument:NSElect 1</pre>
RECEIVER	<pre>:INSTRument[:SElect] RECeiver :INSTRument:NSElect 6</pre>
NETWORK	with option tracking generator FSP-B9 or option external generator control FSP-B10 only --
SCREEN A/B	<p>FULL SCREEN: Selection of the active window: <code>DISPlay[:WINDow&lt;1 2&gt;]:SElect</code> The window valid for the setting is selected by the numeric suffix in the command, eg <code>SENSE&lt;1 2&gt;</code></p> <p>SPLIT SCREEN: The two measurement windows are active. The window valid for the setting is selected by the numeric suffix in the command, eg <code>SENSE&lt;1 2&gt;</code></p>

## Hotkey NETWORK

NETWORK	with option tracking generator FSP-B9 or option external generator control FSP-B10 only --
SOURCE ON / OFF	With option tracking generator FSP-B9 only :OUTPut:STATe ON   OFF
SOURCE POWER	:SOURce:POWer <num_value>
POWER OFFSET	:SOURce:POWer:OFFSet <num_value>
SOURCE CAL	with option tracking generator FSP-B9 or option external generator control FSP-B10 only:
CAL TRANS	:[SENSe:]CORRection:METhod TRANsmission :[SENSe:]CORRection:COLLect[:ACQuire] THRUgh
CAL REFL SHORT	:[SENSe:]CORRection:METhod REFLexion :[SENSe:]CORRection:COLLect[:ACQuire] THRUgh
CAL REFL OPEN	:[SENSe:]CORRection:METhod REFLexion :[SENSe:]CORRection:COLLect[:ACQuire] OPEN
NORMALIZE	:[SENSe:]CORRection[:STATe] ON   OFF
REF VALUE POSITION	:DISPlay[:WINDow<1 2>]:TRACe<1...3>:Y[:SCALe]:RPOSition <num_value>
REF VALUE	:DISPlay[:WINDow<1 2>]:TRACe<1...3>:Y[:SCALe]:RVALue <num_value>
RECALL	:[SENSe:]CORRection:RECall
FREQUENCY OFFSET	With option tracking generator FSP-B9 only :SOURce:FREQuency:OFFSet <num_value>
MODULATION	With option tracking generator FSP-B9 only
EXT AM	:SOURce:AM:STATe ON OFF
EXT FM	:SOURce:FM:STATe ON OFF :SOURce:FM:DEVIation <num_value>
EXT I/Q	:SOURce:DM:STATe ON OFF
MODULATION OFF	--
EXT SOURCE	With option external generator FSP-B10 only
EXT SRC ON / OFF	:SOURce:EXTernal[:STATe] ON   OFF
SELECT GENERATOR	:SYSTem:COMMunicate:RDEvice:GENerator:TYPE 'SME02' :SYSTem:COMMunicate:RDEvice:GENerator:LINK TTL :SYSTem:COMMunicate:GPIB:RDEvice:GENerator:ADDRESS 28
FREQUENCY SWEEP	:SOURce:EXTernal:FREQuency:SWEEP ON   OFF  :SOURce:EXTernal:POWer -30dBm :SOURce:EXTernal:FREQuency:NUMerator 4 :SOURce:EXTernal:FREQuency:DENominator 3 :SOURce:EXTernal:FREQuency:OFFSet 100MHZ

# Contents - Chapter 7 "Remote Control - Programming Examples"

<b>7 Remote Control - Programming Examples .....</b>	<b>7.1</b>
<b>Basic Steps of IEC/IEEE-Bus Programming.....</b>	<b>7.1</b>
Including IEC-Bus Library for VisualBasic .....	7.1
Initialization and Default Status .....	7.2
Creating global variables .....	7.2
Initiate Controller .....	7.2
Initiate Instrument.....	7.3
Configuring Power Save Function of Display .....	7.3
Transmission of Simple Instrument Setting Commands .....	7.4
Return to manual control .....	7.4
Reading out Instrument Settings .....	7.4
Positioning a Marker and Displaying Values .....	7.5
Command synchronization .....	7.6
Service Request .....	7.7
Initiate Service Request.....	7.7
Service request routine .....	7.8
Read Out of Output Buffer.....	7.8
Read Out of Error Messages.....	7.9
Evaluation of SCPI Status Registers .....	7.9
Evaluation of Event Status Register .....	7.10
<b>More Complex Programming Examples.....</b>	<b>7.11</b>
Basic settings of the Receiver .....	7.11
Setting the IEC/IEEE Bus Status Register .....	7.11
Default Setting for Measurements.....	7.12
Using Marker and Delta Marker.....	7.13
Marker Search Functions, Limitation of Search Range.....	7.13
Frequency Counting .....	7.15
Operation mit Fixed Reference Point (Reference Fixed) .....	7.16
Phase and Phase Noise Measurement.....	7.17
Shape Factor Measurement (using n-dB down).....	7.18
Measuring the Third Order Intercept Point.....	7.19
Measuring the AM Modulation Depth .....	7.20
Limit Lines and Limit Test.....	7.21
Measuring the Channel and Adjacent Channel Power .....	7.23
Occupied Bandwidth Measurement.....	7.25
Time Domain Power Measurement.....	7.26
Reading Trace Data .....	7.27
Storing and Loading Device Settings.....	7.29
Storing Instrument Settings .....	7.29
Loading Device Settings.....	7.30
Setting the Data Set for Startup Recall .....	7.30
Reading and Writing Files .....	7.31
Reading a File from the Instrument.....	7.31
Creating a File in the Instrument .....	7.32
Configuring and Starting a Printout.....	7.33



## 7 Remote Control - Programming Examples

The following programming examples have a hierarchical structure, ie subsequent examples are based on previous ones. It is thus possible to compile very easily an operational program from the modules of the given examples.

### Basic Steps of IEC/IEEE-Bus Programming

The examples explain the programming of the instrument and can serve as a basis to solve more complex programming tasks.

VISUAL BASIC has been used as programming language. However, the programs can be translated into other languages.

### Including IEC-Bus Library for VisualBasic

#### Programming hints:

- **Output of texts using the "Print" function**

The following programming examples are based on the assumption that all subroutines are part of a form (file extension: .FRM). In this case the syntax

```
Print "Text"
```

is allowed.

If however the subroutines are stored as a so-called module (file extension: .BAS), the print instruction should be preceded by the name of a form which has the required print method. If, for example, there is a form with the name "Main", the associated print instruction is as follows:

```
Main.Print "Text".
```

- **Access to functions of GPIB.DLL**

To create Visual Basic control applications the file GPIB.BAS (as from VB 6.0 VBIB-32.BAS) is added to a project so that the functions of the RSIB.DLL can be called. In addition, the file NIGLOBAL.BAS is added to the project. This file contains constants and definitions for the processing of errors, timeout values, etc.

- **Declaration of DLL functions as procedures**

Since the functions all return an integer value, the functions in the file GPIB.BAS are all declared as follows:

```
Declare Function xxx Lib "gpib.dll" ( ... ) As Integer
```

The function value with the status variables `ibsta` should be allocated a variable when it is called up. Since this value is also returned via a reference parameter of the functions, the functions can be declared as procedures as follows:

```
Declare Sub xxx Lib "rsib.dll" ( ... )
```



- **Generating a response buffer**

Since the DLL returns zero-terminated strings in case of responses, a string of sufficient length should be generated prior to calling the functions `ibrd()` and `ilrd()`, since Visual Basic prefixes a length value to the strings which is not updated by the DLL.

The following two possibilities are available to generate a length value for a string:

```
- Dim Rd as String * 100
- Dim Rd as String
  Rd = Space$(100)
```

## Initialization and Default Status

Variables used by all subroutines should be stored at the beginning of every program. Then the IEC/IEEE bus as well as the settings of the instrument are brought into a defined default status at the beginning of every program. Subroutines "InitController" and "InitDevice" are used to this effect.

### Creating global variables

Global variables are placed in so-called "modules" (file extension: .BAS) in Visual Basic. Therefore, at least one module (z.B. "GLOBALS.BAS) should be created which contains the variables used by all subroutines, such as the device addresses used by the IEC/IEEE-bus driver.

The file should contain the following instructions for the programming examples below:

```
Global receiver As Integer
Global boardId As Integer
```

### Initiate Controller

```
REM ----- Initiate controller -----
Public SUB InitController()

ieaddress% = 20                                'IEC/IEEE-bus address of the
                                              'instrument

CALL IBFIND("GPIB0", boardId%)                'Open port to the controller
CALL IBFIND("DEV1", receiver%)               'Open port to the instrument
CALL IBPAD(receiver%, ieaddress%)            'Inform controller on instrument
                                              'address

CALL IBTMO(receiver%, 11)                     'Response time to 1 sec

END SUB
REM *****
```

## Initiate Instrument

The IEC-bus status registers and instrument settings of the instrument are brought into the default status.

```

REM ----- Initiate instrument -----
Public SUB InitDevice()

CALL IBWRT(receiver%, "*CLS")           'Reset status registers
CALL IBWRT(receiver%, "*RST")           'Reset instrument
END SUB
REM*****

```

## Configuring Power Save Function of Display

The results on the screen are often not required during IEC/IEEE-bus operation. Although the command "SYSTEM:DISPlay:UPDate OFF" switches off the display of results which brings considerable advantages in terms of speed in the remote control mode, the display itself and in particular the backlighting remain switched on.

If required, the display should be switched off by means of the power-save function, the response time having to be set in minutes prior to activation.

**Note:**        *The display is switched on as soon as a key is pressed on the instrument front panel.*

```

REM ----- Configure power save function -----
Public SUB PowerSave()

CALL IBWRT(receiver%, "SYSTEM:PSAVE:HOLDoff 1") 'Set holdoff to 1 minute
CALL IBWRT(receiver%, "SYSTEM:PSAVE ON")         'Power save function on
END SUB
REM*****

```

## Transmission of Simple Instrument Setting Commands

Center frequency, span, and reference level of the instrument are set in this example.

```

REM ----- Instrument setting commands -----
PUBLIC SUB SimpleSettings()

CALL IBWRT(receiver%, "FREQUENCY:CENTER 128MHZ") 'Center frequency 128 MHz
CALL IBWRT(receiver%, "FREQUENCY:SPAN 10MHZ")    'Span 10 MHz
CALL IBWRT(receiver%, "DISPLAY:TRACE:Y:RLEVEL -10dBm")
                                                    'Reference level -10dBm

END SUB
REM *****

```

## Return to manual control

```

REM ----- Switch instrument over to manual control -----
CALL IBLOC(receiver%) 'Set instrument to Local state
REM *****

```

## Reading out Instrument Settings

The settings made in the above example are read out here. The abbreviated commands are used.

```

REM ----- Reading out instrument settings -----
PUBLIC SUB ReadSettings()

CFfrequency$ = SPACE$(20) 'Provide text variables (20 characters)
CALL IBWRT(receiver%, "FREQ:CENT?") 'Request center frequency
CALL IBRD(receiver%, CFfrequency$) 'Read value

CFspan$ = SPACE$(20) 'Provide text variables (20 characters)
CALL IBWRT(receiver%, "FREQ:SPAN?") 'Query span
CALL IBRD(receiver%, CFspan$) 'Read value

RLevel$ = SPACE$(20) 'Provide text variables (20 characters)
CALL IBWRT(receiver%, "DISP:TRAC:Y:RLEV?")
                                                    'Query reference level
CALL IBRD(receiver%, RLevel$) 'Read value

```

```

REM ----- Display values on the screen -----
PRINT "Center frequency: "; CFfrequency$,
PRINT "Span:           "; CFspan$,
PRINT "Reference level: "; RLevel$,
REM*****

```

## Positioning a Marker and Displaying Values

```

REM ----- Examples of marker functions -----
PUBLIC SUB ReadMarker()

CALL IBWRT(receiver%, "CALC:MARKER ON;MARKER:MAX")
      'Activate marker1 and start peak search
MKmark$ = SPACE$(30)           'Provide text variables (30 characters)
CALL IBWRT(receiver%, "CALC:MARK:X?;Y?")      'Query frequency and level
CALL IBRD(receiver%, MKmark$)                'Read value

REM ----- Display values on the screen -----
PRINT "Center frequency / level "; MKmark$,
REM *****

```

## Command synchronization

The possibilities for synchronization implemented in the following example are described in Chapter 5, Section "Command Order and Command Synchronization".

```

REM ----- Examples of command synchronization -----
PUBLIC SUB SweepSync()

REM The command INITiate[:IMMediate] starts a single sweep if the command
REM INIT:CONT OFF was previously sent. It should be ensured that the next
REM command is only then executed when the entire sweep is complete.

CALL IBWRT(receiver%, "INIT:CONT OFF")

REM ----- First possibility: Use of *WAI -----
CALL IBWRT(receiver%, "ABOR;INIT:IMM; *WAI")

REM ----- Second possibility: Use of *OPC? -----
OpcOk$ = SPACE$(2)                'Space for *OPC? - Provide response
CALL IBWRT(receiver%, "ABOR;INIT:IMM; *OPC?")
REM ----- here the controller can service other instrument-----
CALL IBRD(receiver%, OpcOk$)      'Wait for "1" from *OPC?

REM ----- Third possibility: Use of *OPC -----
REM In order to be able touse the service request function in conjugation
REM with a National Instruments GPIB driver, the setting "Disable
REM Auto Serial Poll" must be changed to "yes" by means of IBCONF!
CALL IBWRT(receiver%, "*SRE 32")  'Permit service request for ESR
CALL IBWRT(receiver%, "*ESE 1")   'Set event-enable bit for
                                     'operation-complete bit
CALL IBWRT(receiver%, "ABOR;INIT:IMM; *OPC") 'Start sweep and
                                               'synchronize with OPC
CALL WaitSRQ(boardID%,result%)    'Wait for service request
REM Continue main program here.

END SUB
REM *****

```

## Service Request

The service request routine requires an extended initialization of the instrument in which the respective bits of the transition and enable registers are set.

In order to use the service request function in conjugation with National Instruments GPIB driver, the setting "Disable Auto Serial Poll" must be changed to "yes" by means of IBCONF.

### Initiate Service Request

```

REM ---- Example of initialization of the SRQ in the case of errors -----
PUBLIC SUB SetupSRQ()

CALL IBWRT(receiver%, "*CLS")           'Reset status reporting system
CALL IBWRT(receiver%, "*SRE 168")      'Permit service request for
                                        'STAT:OPER, STAT:QUES and ESR
                                        'register

CALL IBWRT(receiver%, "*ESE 60")       'Set event-enable bit for
                                        'command, execution, device-
                                        'dependent and query error

CALL IBWRT(receiver%, "STAT:OPER:ENAB 32767") 'Set OPERation enable bit for
                                        'all events

CALL IBWRT(receiver%, "STAT:OPER:PTR 32767") 'Set appropriate OPERation
                                        'Ptransition bits

CALL IBWRT(receiver%, "STAT:QUES:ENAB 32767") 'Set questionable enable bits
                                        'for all events

CALL IBWRT(receiver%, "STAT:QUES:PTR 32767") 'Set appropriate questionable
                                        'Ptransition bits

CALL WaitSRQ(boardID%, result%)        'Wait for Service Request
IF (result% = 1) THEN CALL Srq         'If SRQ is recognized =>
                                        'subroutine for evaluation

END SUB
REM *****

```

## Service request routine

A service request is then processed in the service request routine.

Note: the variables userN% and userM% must be pre-assigned usefully!

```

REM ----- Service request routine -----
Public SUB Srq()

ON ERROR GOTO noDevice           'No user existing
CALL IBRSP(receiver%, STB%)     'Serial poll, read status byte
IF STB% > 0 THEN                 'This instrument has bits set
                                'in the STB

    SRQFOUND% = 1
    IF (STB% AND 16) > 0 THEN CALL Outputqueue
    IF (STB% AND 4) > 0 THEN CALL ErrorQueueHandler
    IF (STB% AND 8) > 0 THEN CALL Questionablestatus
    IF (STB% AND 128) > 0 THEN CALL Operationstatus
    IF (STB% AND 32) > 0 THEN CALL Esrread
END IF

noDevice:
END SUB                         'End of SRQ routine

```

```

REM *****

```

Reading out the status event registers, the output buffer and the error/event queue is effected in subroutines.

## Read Out of Output Buffer

```

REM ----- Subroutine for the individual STB bits -----
Public SUB Outputqueue()        'Reading the output buffer

result$ = SPACE$(100)          'Make space for response
CALL IBRD(receiver%, result$)
PRINT "Contents of Output Queue : "; result$
END SUB

REM *****

```

## Read Out of Error Messages

```

REM ----- Subroutine for reading the error queue -----
Public SUB ErrorQueueHandler()
ERROR$ = SPACE$(100)           'Make space for error variable
CALL IBWRT(receiver%, "SYSTEM:ERROR?")
CALL IBRD(receiver%, ERROR$)
PRINT "Error Description : "; ERROR$
END SUB
REM *****

```

## Evaluation of SCPI Status Registers

```

REM ----- Subroutine for evaluating Questionable Status-Register -----
Public SUB Questionablestatus()
Ques$ = SPACE$(20)           'Preallocate blanks to text variable
CALL IBWRT(receiver%, "STATUS:QUESTIONABLE:EVENT?")
CALL IBRD(receiver%, Ques$)
PRINT "Questionable Status: "; Ques$
END SUB
REM *****

```

```

REM ----- subroutine for evaluating Operation Status-Register -----
Public SUB Operationstatus()
Oper$ = SPACE$(20)           'Preallocate blanks to text variable
CALL IBWRT(receiver%, "STATUS:OPERATION:EVENT?")
CALL IBRD(receiver%, Oper$)
PRINT "Operation Status: "; Oper$
END SUB
REM *****

```



**Evaluation of Event Status Register**

```
REM ----- Subroutine for evaluating the Event Status Register -----
Public SUB Esrread()
Esr$ = SPACE$(20)           'Preallocate blanks to text variable
CALL IBWRT(receiver%, "*ESR?")           'Read ESR
CALL IBRD(receiver%, Esr$)
IF (VAL(Esr$) AND 1) > 0 THEN PRINT "Operation complete"
IF (VAL(Esr$) AND 2) > 0 THEN PRINT "Request Control"
IF (VAL(Esr$) AND 4) > 0 THEN PRINT "Query Error"
IF (VAL(Esr$) AND 8) > 0 THEN PRINT "Device dependent error"
IF (VAL(Esr$) AND 16) > 0 THEN
    PRINT "Execution Error; Program aborted" ' Output error message
    STOP                                     'Stop software
    END IF
IF (VAL(Esr$) AND 32) > 0 THEN
    PRINT "Command Error; Program aborted" ' Output error message
    STOP                                     'Stop software
    END IF
IF (VAL(Esr$) AND 64) > 0 THEN PRINT "User request"
IF (VAL(Esr$) AND 128) > 0 THEN PRINT "Power on"
END SUB
REM *****
```

## More Complex Programming Examples

### Basic settings of the Receiver

The following settings are an example of how to modify the default setting of ESPI.

It should be noted that only some settings are necessary depending on the example of application. In particular, the settings for resolution bandwidth, video bandwidth and sweep time are often not needed since these parameters are automatically calculated in the default setting on modifying the frequency range (span). The insertion loss is also automatically calculated depending on the reference level. The level detectors are coupled to the selected trace mode in the default setting.

The settings which are automatically calculated in the default setting are marked by (\*) in the following programming example.

### Setting the IEC/IEEE Bus Status Register

```

REM *****
Public Sub SetupStatusReg()

'----- IEEE 488.2 status register -----
CALL IBWRT(receiver%,"*CLS")           'Reset Status Registers
CALL IBWRT(receiver%,"*SRE 168")      'Enable service request
                                        'for STAT:OPER-,STAT:QUES- and
                                        'ESR registers
CALL IBWRT(receiver%,"*ESE 61")      'Set Event-Enable bit for:
                                        'Operation Complete
                                        'Command-, Execution-,Device
                                        'Dependent- and Query Error

'----- SCPI status register -----
CALL IBWRT(receiver%,"STAT:OPER:ENAB 0") 'Disable OPERation Status Reg
CALL IBWRT(receiver%,"STAT:QUES:ENAB 0") 'Disable Questionable Status
                                        'Register

End Sub
REM *****

```

## Default Setting for Measurements

```

REM *****
Public Sub SetupInstrument()

'----- Basic settings -----
CALL SetupStatusReg           'Set status registers
CALL IBWRT(receiver%,"*RST")  'Reset instrument
CALL IBWRT(receiver%,"SYST:DISP:UPD ON") 'ON: display indication on
                                'OFF: off(improved
                                '      performance)

CALL IBWRT(receiver%,"DISP:FORM SINGLE") 'Full screen
CALL IBWRT(receiver%,"DISP:WIND1:SEL")   'Active screen A
CALL IBWRT(receiver%,"INIT:CONT OFF")    'Single sweep

'----- Set frequency -----
CALL IBWRT(receiver%,"FREQUENCY:CENTER 100MHz") 'Center frequency
CALL IBWRT(receiver%,"FREQ:SPAN 1 MHz")         'Span

'----- Set level -----
CALL IBWRT(receiver%,"DISP:WIND:TRAC:Y:RLEV -20dBm") 'Reference level
CALL IBWRT(receiver%,"INP:ATT 10dB")                'Input attenuation (*)

'----- Scale y-axis -----
CALL IBWRT(receiver%,"DISP:WIND:TRAC:Y:SPAC LOG")    'Log level axis
CALL IBWRT(receiver%,"DISP:WIND:TRAC:Y:SCAL 100dB")  'Level range
CALL IBWRT(receiver%,"DISP:WIND:TRAC:Y:SCAL:MODE ABS") 'Absolute scaling
CALL IBWRT(receiver%,"CALC:UNIT:POW DBM")           'Unit of y-axis

'----- Trace and detector settings -----
CALL IBWRT(receiver%,"DISP:WIND:TRAC1:MODE AVER")    'Trace1 average
CALL IBWRT(receiver%,"AVER:TYPE VID")                'Average mode video;
                                                '"LIN" for linear

CALL IBWRT(receiver%,"SWE:COUN 10")                 'Sweep count
CALL IBWRT(receiver%,"DISP:WIND:TRAC2:STAT OFF")    'Trace2 blank
CALL IBWRT(receiver%,"DISP:WIND:TRAC3:STAT OFF")    'Trace3 blank
CALL IBWRT(receiver%,"CALC:MATH:STAT OFF")          'Trace mathematics off

CALL IBWRT(receiver%,"DETECTOR1 RMS")               'Detector Trace1  (*)
CALL IBWRT(receiver%,"DET2:AUTO ON")                 'Detector Trace2  (*)
CALL IBWRT(receiver%,"DET3:AUTO ON")                 'Detector Trace3  (*)

'----- Band width and sweep time -----
CALL IBWRT(receiver%,"BAND:RES 100KHz")              'Resolution BW (*)
CALL IBWRT(receiver%,"BAND:VID 1MHz")                'Video bandwidth  (*)
CALL IBWRT(receiver%,"SWE:TIM 100ms")               'Sweep time      (*)

END SUB
REM *****

```

## Using Marker and Delta Marker

### Marker Search Functions, Limitation of Search Range

The example below is based on an AM-modulated signal at 100 MHz with the following characteristics:

- Carrier signal level: -30 dBm
- AF frequency: 100 kHz
- Modulation depth: 50 %

Marker 1 and delta marker 2 are set one after the other to the highest maxima of the measurement curve and then the frequency and level are read out. The default setting of the receiver can be used for the following measurements (SetupInstrument).

REM \*\*\*\*\*

Public Sub MarkerSearch()

result\$ = Space\$(100)

CALL SetupInstrument 'Basic setting

'----- Peak search without search limit -----

CALL IBWRT(receiver%,"INIT:CONT OFF") 'Switch to single sweep

CALL IBWRT(receiver%,"CALC:MARK:PEXC 6DB") 'Peak Excursion

CALL IBWRT(receiver%,"CALC:MARK:STAT ON") 'Switch on Marker 1

CALL IBWRT(receiver%,"CALC:MARK:TRAC 1") 'Assign marker1 to Trace 1

CALL IBWRT(receiver%,"INIT;\*WAI") 'Sweep with sync

CALL IBWRT(receiver%,"CALC:MARK:MAX;X?;Y?") 'Marker to peak; read out

CALL IBRD(receiver%, result\$) 'frequency and level

Print "Marker 1: ";result\$

CALL IBWRT(receiver%,"CALC:DELT2:STAT ON;MAX;MAX:LEFT")

'Switch on delta marker 2

'Peak and then Next Peak Left

CALL IBWRT(receiver%,"CALC:DELT:MODE ABS") 'Delta marker 2 frequency output  
'absolute

CALL IBWRT(receiver%,"CALC:DELT2:X?;Y?") 'Delta marker 2 - Read out  
'frequency and level

CALL IBRD(receiver%, result\$)

Print "Delta 2: ";result\$

```

'----- Peak search with search limit in x-direction -----
CALL IBWRT(receiver%,"CALC:DELT:MODE REL") 'Delta marker frequency output
                                         'relative

CALL IBWRT(receiver%,"CALC:MARK:X:SLIM:STAT ON;LEFT 0Hz;RIGHT 100.05MHz")
                                         'Search limit on and set below
                                         'LF on the right side

CALL IBWRT(receiver%,"CALC:DELT3:STAT ON;MAX;MAX:RIGHT")
                                         'Delta marker 3      on
                                         'Peak and then Next Peak Right

CALL IBWRT(receiver%,"CALC:DELT3:X?;Y?")
                                         'Delta marker 3; Read out
                                         'frequency und level, both must

CALL IBRD(receiver%, result$)
                                         'have the value 0

Print "Delta 3: ";result$

'----- Peak search with search limit in y-direction -----
CALL IBWRT(receiver%,"CALC:DELT:MODE REL") 'Deltamarker frequency output
                                         'relative

CALL IBWRT(receiver%,"CALC:THR -35DBM;THR:STAT ON")
                                         'Threshold on and set above LF

CALL IBWRT(receiver%,"CALC:DELT3:STAT ON;MAX;MAX:NEXT")
                                         'Delta marker 3 on
                                         'Peak and then Next Peak
                                         ' => is not found

CALL IBWRT(receiver%,"CALC:DELT3:X:REL?;:CALC:DELT:Y?")
CALL IBRD(receiver%, result$)
                                         'Delta marker 3; Read out
                                         'Frequency und level, both must

CALL IBRD(receiver%, result$)
                                         'have the value 0

Print "Delta 3: ";result$

'---- Set center frequency and reference level by means of markers -----
CALL IBWRT(receiver%,"CALC:MARK2:FUNC:CENT") 'Delta marker 2 -> Marker and
                                         'center frequency = Marker 2

CALL IBWRT(receiver%,"CALC:MARK2:FUNC:REF") 'Ref level = Marker 2

Call ibwrt(receiver%,"INIT;*WAI")
                                         'Sweep with sync

END SUB

REM *****

```

## Frequency Counting

The following example is based on a signal with a level of -30 dBm at 100 MHz. The default setting of the receiver can also be used for this measurement (SetupInstrument). The objective of frequency counting is to determine the exact frequency of the signal at 100 MHz.

```

REM *****
Public Sub MarkerCount()

result$ = Space$(100)
CALL SetupInstrument           'Basic settings
'----- Measure signal frequency with frequency counter -----
CALL IBWRT(receiver%,"INIT:CONT OFF")           'Single sweep on
CALL IBWRT(receiver%,"CALC:MARK:PEXC 6DB")      'Peak Excursion
CALL IBWRT(receiver%,"CALC:MARK:STAT ON")       'Marker 1 on
CALL IBWRT(receiver%,"CALC:MARK:TRAC 1")       'Assign marker1 to trace 1
CALL IBWRT(receiver%,"CALC:MARK:X 100MHZ")     'Set Marker1 to 100MHz
CALL IBWRT(receiver%,"CALC:MARK:COUNT:RES 1HZ") 'Frequency counter 1Hz
CALL IBWRT(receiver%,"CALC:MARK:COUNT ON")    'frequency counter on
CALL IBWRT(receiver%,"INIT;*WAI")              'Sweep with sync
CALL IBWRT(receiver%,"CALC:MARK:COUNT:FREQ?") 'Read out frequency
Print "Marker Count Freq: ";result$
END SUB
REM *****

```

## Operation mit Fixed Reference Point (Reference Fixed)

The following example is based on a signal with a level of  $-20$  dBm at 100 MHz. The harmonics of the signal lie at 200 MHz, 300 MHz, etc. In the presence of high-quality signal sources these harmonics may lie out of the dynamic range of ESPI. In order to measure harmonic suppression, however, the level should be set to higher sensitivity for measuring the harmonics; the carrier has to be suppressed by a notch filter to avoid overloading the receiver RF input.

In the following example two measurements are therefore performed with different level settings, first with a high reference level at the carrier frequency and then with a low reference level at the frequency of the 3<sup>rd</sup> harmonic.

The default setting of the receiver for measurements (SetupInstrument) is used as starting point and adaptations are then made for the measurement.

```

REM *****
Public Sub RefFixed()

result$ = Space$(100)
CALL SetupInstrument           'Basic settings
'----- Measure the reference point -----
CALL IBWRT(receiver%,"INIT:CONT OFF")           'Single sweep
CALL IBWRT(receiver%,"CALC:MARK:PEXC 6DB")      'Peak Excursion
CALL IBWRT(receiver%,"CALC:MARK:STAT ON")       'Marker1 on
CALL IBWRT(receiver%,"CALC:MARK:TRAC 1")       'Assign marker1 to Trace 1
CALL IBWRT(receiver%,"INIT;*WAI")              'Sweep with sync
CALL IBWRT(receiver%,"CALC:MARK:MAX")          'Set Marker1 to 100MHz
CALL IBWRT(receiver%,"CALC:DELT:FUNC:FIX ON")   'Reference fixed
'-----Setting freq., level and bandw. for meas. of harmonic distortion -----
CALL IBWRT(receiver%,"FREQ:CENT 400MHz;Span 1MHz") 'Set freq. of 3rd harmonic
CALL IBWRT(receiver%,"BAND:RES 1kHz")          'and appropriate RBW
CALL IBWRT(receiver%,"SWEEP:TIME:AUTO ON")      'Couple sweep time
CALL IBWRT(receiver%,"INP:ATT:AUTO ON")        'Optimize level
CALL IBWRT(receiver%,"DISP:WIND:TRAC:Y:RLEV -50dBm")
CALL IBWRT(receiver%,"INIT;*WAI")              'Sweep with sync
CALL IBWRT(receiver%,"CALC:DELT:MODE REL")      'Delta marker frequency
                                                'relative
CALL IBWRT(receiver%,"CALC:DELT:MAX;X?;Y?")    'Read out delta marker
Call ibrd(receiver%, result$)                  'Read out frequency and level
Print "Deltamarker 1: "; result$
END SUB
REM *****

```

## Phase and Phase Noise Measurement

During phase noise measurement the noise power referred to 1 Hz is brought into proportion to the power of an adjacent carrier signal. The spacing often used between the measured frequency and the carrier frequency is 10 kHz.

For the noise measurement the measured absolute level is referred to a bandwidth of 1 Hz.

The following example is again based on a signal with a level of  $-30$  dBm at 100 MHz. Two markers are used to determine the noise and the phase noise at an offset of 10 kHz from the carrier signal.

```

REM *****
Public Sub Noise()

result$ = Space$(100)

'----- Basic settings -----
CALL SetupStatusReg           'Configure status register
CALL IBWRT(receiver%,"*RST")  'Reset instrument
CALL IBWRT(receiver%,"INIT:CONT OFF") 'Single sweep

'----- Set frequency -----
CALL IBWRT(receiver%,"FREQUENCY:CENTER 100MHz") 'Center frequency
CALL IBWRT(receiver%,"FREQ:SPAN 100 kHz")       'Span

'----- Set level -----
CALL IBWRT(receiver%,"DISP:WIND:TRAC:Y:RLEV -20dBm") 'Reference level
CALL IBWRT(receiver%,"INIT;*WAI")                   'Sweep with sync

'----- Set reference point -----
CALL IBWRT(receiver%,"CALC:MARK:PEXC 6DB")          'Peak Excursion
CALL IBWRT(receiver%,"CALC:MARK:STAT ON")           'Marker1 on
CALL IBWRT(receiver%,"CALC:MARK:TRAC 1")           'Assign marker1 to trancel
CALL IBWRT(receiver%,"CALC:MARK:MAX")              'Set marker1 to 100MHz
CALL IBWRT(receiver%,"CALC:DELT:FUNC:PNO ON")       'Phase Noise on

'----- Measure phase noise -----
CALL IBWRT(receiver%,"CALC:DELT:X 10kHz")           'Set delta marker
CALL IBWRT(receiver%,"CALC:DELT:FUNC:PNO:RES?")    'Read out result of
Call ibrd(receiver%, result$)                       'Phase Noise meas.
Print "Phase Noise [dBc/Hz]: "; result$

'----- Measure noise -----
CALL IBWRT(receiver%,"CALC:MARK:X 99.96MHz")       'Set Marker 1
CALL IBWRT(receiver%,"CALC:MARK:FUNC:NOIS:RES?")   'Read out result
Call ibrd(receiver%, result$)
Print "Noise [dBm/Hz]: "; result$

END SUB

REM *****

```



## Shape Factor Measurement (using n-dB down)

The n-dB-down function of the receiver is used twice to determine the shape factor of a filter (ratio of bandwidths at 60 dB and 3 dB below the filter maximum).

The following example is again based on a signal with a level of -30 dBm at 100 MHz. The shape factor is determined for the 30 kHz resolution bandwidth. The default setting of the receiver is used for measurements (SetupInstrument).

```

REM *****
Public Sub ShapeFactor()

result$ = Space$(100)

'----- Basic settings receiver -----
CALL SetupInstrument           'Basic settings
CALL IBWRT(receiver%,"INIT:CONT OFF") 'Single sweep

'----- Set frequency -----
CALL IBWRT(receiver%,"FREQ:SPAN 1MHz") 'Span
CALL IBWRT(receiver%,"BAND:RES 30kHz") 'Resolution bandwidth
CALL IBWRT(receiver%,"INIT;*WAI") 'Sweep with sync

'----- Measure 60 dB value -----
CALL IBWRT(receiver%,"CALC:MARK:PEXC 6DB") 'Peak Excursion
CALL IBWRT(receiver%,"CALC:MARK:STAT ON") 'Marker1 on
CALL IBWRT(receiver%,"CALC:MARK:TRAC 1") 'Assign marker1 to Trace 1
CALL IBWRT(receiver%,"CALC:MARK:MAX") 'Set marker1 to 100MHz

CALL IBWRT(receiver%,"CALC:MARK:FUNC:NDBD 60dB") 'Bandbreite bei 60dB messen
CALL IBWRT(receiver%,"CALC:MARK:FUNC:NDBD:RES?") 'und auslesen
CALL IBRD(receiver%,result$)

result60 = Val(result$)

'----- Measure 3 dB Down value -----
CALL IBWRT(receiver%,"CALC:MARK:FUNC:NDBD 3dB") 'Read out bandwidth at 60dB
CALL IBWRT(receiver%,"CALC:MARK:FUNC:NDBD:RES?")
CALL IBRD(receiver%,result$)

result3 = Val(result$)

'----- Read out shape factor-----
Print "Shapefaktor 60dB/3dB: ";result60/result3

END SUB

REM *****

```

## Measuring the Third Order Intercept Point

The intercept point of 3<sup>rd</sup> order is the (virtual) level of two adjacent useful signals at which the intermodulation products of 3<sup>rd</sup> order have the same level as the useful signals.

The intermodulation product at  $f_{S2}$  is obtained by mixing the first harmonic of useful signal  $P_{N2}$  with signal  $P_{N1}$ , the intermodulation product at  $f_{S1}$  by mixing the first harmonic of useful signal  $P_{N1}$  with signal  $P_{N2}$ .

$$f_{S1} = 2 \times f_{n1} - f_{n2}(1)$$

$$f_{S2} = 2 \times f_{n2} - f_{n1}(2)$$

The following example is based on two adjacent signals with a level of -30 dBm at 100 MHz and 110 MHz. The intermodulation products lie at 90 MHz and 120 MHz according to the above formula. The frequency set is in a way that the examined mixture products are displayed on the diagram. Otherwise the default setting of the receiver is used for measurements (SetupInstrument).

```

REM *****
Public Sub TOI()

result$ = Space$(100)

'----- Basic settings -----
CALL SetupStatusReg           'Set status registers
CALL IBWRT(receiver%,"*RST")  'Reset instrument
CALL IBWRT(receiver%,"INIT:CONT OFF") 'Single sweep
CALL IBWRT(receiver%,"SYST:DISP:UPD ON") 'ON: display indication on
                                         'OFF: off

'----- Set frequency -----
CALL IBWRT(receiver%,"FREQ:START 85MHz;STOP 125 MHz") 'Span

'----- Set level -----
CALL IBWRT(receiver%,"DISP:WIND:TRAC:Y:RLEV -20dBm") 'Reference level
CALL IBWRT(receiver%,"INIT;*WAI") 'Sweep with sync

'----- TOI measurement -----
CALL IBWRT(receiver%,"CALC:MARK:PEXC 6DB") 'Peak Excursion
CALL IBWRT(receiver%,"CALC:MARK:FUNC:TOI ON") 'TOI on
CALL IBWRT(receiver%,"CALC:MARK:FUNC:TOI:RES?") 'and read out results
CALL IBRD(receiver%,result$)

'----- Read out result -----
Print "TOI [dBm]: ";result$

END SUB

REM *****

```

## Measuring the AM Modulation Depth

The example below is based on an AM-modulated signal at 100 MHz with the following characteristics:

- Carrier signal level: -30 dBm
- AF frequency: 100 kHz
- Modulation depth: 50 %

The default setting of the receiver for measurements can be used for the measurements described below (SetupInstrument).

```

REM *****
Public Sub AMMod()

result$ = Space$(100)
CALL SetupInstrument           'Basic settings
'----- Peak search -----
CALL IBWRT(receiver%,"INIT:CONT OFF")      'Single sweep
CALL IBWRT(receiver%,"INIT;*WAI")         'Sweep with sync
CALL IBWRT(receiver%,"CALC:MARK:PEXC 6DB")  'Peak Excursion
CALL IBWRT(receiver%,"CALC:MARK:STAT ON")   'Marker 1 on
CALL IBWRT(receiver%,"CALC:MARK:TRAC 1")   'Assign marker1 to trace 1
'----- Measure modulation depth-----
CALL IBWRT(receiver%,"CALC:MARK:MAX;FUNC:MDEP ON") 'Marker to Peak;
CALL IBWRT(receiver%,"CALC:MARK:FUNC:MDEP:RES?")  'Mod. Depth on
CALL IBRD(receiver%, result$)                  'Read out result
'----- Read out result -----
Print "AM Mod Depth [%]: ";result$
END SUB
REM *****

```

## Limit Lines and Limit Test

The example below shows the definition and use of a new limit line 5 for trace 1 on screen A and trace 2 on screen B with the following characteristics:

- Upper limit line
- Absolute x axis in the frequency range
- 5 reference values: 120 MHz / -70 dB, 126 MHz/-40 dB, 127 MHz/-40 dB, 128 MHz/-10 dB, 129 MHz/-40 dB, 130 MHz/-40 dB, 136 MHz / - 70 dB
- Relative y axis with unit dB
- Absolute threshold at -75 dBm
- No margin

The signal of the integrated calibration source (128 MHz, -30 dBm) is used to check the limit test.

```

REM *****
Public Sub LimitLine()

result$ = Space$(100)

'----- Basic settings -----
CALL SetupInstrument                'Basic settings
CALL IBWRT(receiver%,"FREQUENCY:CENTER 128MHZ;Span 10MHZ")'Span
Call ibwrt(receiver%,"Diag:Serv:Inp Cal;CSO -30dBm")  'Cal signal on

'----- Definition of limit lines -----
CALL IBWRT(receiver%,"CALC:LIM5:NAME 'TEST1'")        'Define name
CALL IBWRT(receiver%,"CALC:LIM5:COMM 'Upper limit'")  'Define comment
CALL IBWRT(receiver%,"CALC1:LIM5:TRAC 1")            'Assign trace in screen A
CALL IBWRT(receiver%,"CALC2:LIM5:TRAC 2")            'Assign trace in screen B
CALL IBWRT(receiver%,"CALC:LIM5:CONT:DOM FREQ")      'Define x-axis range
CALL IBWRT(receiver%,"CALC:LIM5:CONT:MODE ABS")      'Define x-axis scaling
CALL IBWRT(receiver%,"CALC:LIM5:UNIT DB")            'Define y-axis unit
CALL IBWRT(receiver%,"CALC:LIM5:UPP:MODE REL")      'Define y-axis scaling

'----- Definition of data points and threshold -----
xlimit$ = "CALC:LIM5:CONT 120MHZ,126MHZ,127MHZ,128MHZ,129MHZ,130MHZ,136MHZ"
CALL IBWRT(receiver%, xlimit$)                       'Set values for x-axis
CALL IBWRT(receiver%,"CALC:LIM5:UPP -70,-40,-40,-20,-40,-40,-70")
                                                    'Set values for y-axis

CALL IBWRT(receiver%,"CALC:LIM5:UPP:THR -75DBM")     'Set y-threshold (only
                                                    'possible for relative
                                                    'y-axis)

'-----
'A margin or an x-/y offset can be defined here.

'----- Activate and evaluate the limit line in screen A -----
CALL IBWRT(receiver%,"CALC1:LIM5:UPP:STAT ON")      'Activate line 5 in screen A
CALL IBWRT(receiver%,"CALC1:LIM5:STAT ON")          'Activate limit check in
                                                    'screen A
CALL IBWRT(receiver%,"INIT;*WAI")                  'Sweep with sync

```

```
CALL IBWRT(receiver%,"CALC1:LIM5:FAIL?")      'Query result of limit
                                              'check
CALL IBRD(receiver%, result$)                 'Result: 1 (= FAIL)
'----- Read out result -----
Print "Limit Result Line 5: ";result$

'----- Evaluate limit line in screen A by means of status registers -----
CALL IBWRT(receiver%,"*CLS")                  'Reset status register
'----- Measure -----
CALL IBWRT(receiver%,"INIT;*OPC")             'Sweep with sync
CALL WaitSRQ(boardID%,status%)               'Wait for service request
'----- Read out result -----
IF (status% = 1) THEN
    CALL IBWRT(receiver%,"STAT:QUES:LIM1:COND?") 'Read out STAT:QUES:Limit
    CALL IBRD(receiver%, result$)              'register
    IF ((Val(result$) And 16) <> 0) THEN
        Print "Limit5 failed"
    ELSE
        Print "Limit5 passed"
    END IF
END IF
END IF
END SUB
REM *****
```

## Measuring the Channel and Adjacent Channel Power

In the following example the channel and adjacent channel power is first measured on a signal with a level of 0 dBm at 800 MHz to IS95. Then the channel and adjacent channel power is measured on a GSM signal at 935.2 MHz with fast ACP measurement (FAST ACP).

In addition, the limit test is activated.

```

REM *****
Public Sub ACP()

result$ = Space$(100)

'----- Basic settings -----
CALL SetupStatusReg           'Set status register
CALL IBWRT(receiver%,"*RST")  'Reset instrument
CALL IBWRT(receiver%,"INIT:CONT OFF") 'Single sweep
CALL IBWRT(receiver%,"SYST:DISP:UPD ON") 'ON: display indication on
                                         'OFF: off

'----- Set frequency -----
CALL IBWRT(receiver%,"FREQ:CENT 800MHz") 'Set frequency

'----- Set level -----
CALL IBWRT(receiver%,"DISP:WIND:TRAC:Y:RLEV 10dBm") 'Reference level

'----- Example 1: Configure CP/ACP for CDMA -----
CALL IBWRT(receiver%,"CALC2:MARK:FUNC:POW:SEL ACP") 'ACP measurement on
CALL IBWRT(receiver%,"CALC:MARK:FUNC:POW:PRES F8CDMA") 'Select CDMA800 FWD
CALL IBWRT(receiver%,"SENS:POW:ACH:ACP 2") 'Select 2 adjacent channels
CALL IBWRT(receiver%,"SENS:POW:ACH:PRES ACP") 'Optimize settings
CALL IBWRT(receiver%,"SENS:POW:ACH:PRES:RLEV") 'Optimize reference level
CALL IBWRT(receiver%,"SENS:POW:ACH:MODE ABS") 'Absolute measurement
CALL IBWRT(receiver%,"SENS:POW:HSP ON") 'Fast ACP measurement

'----- Measure and query result -----
CALL IBWRT(receiver%,"INIT;*WAI") 'Sweep with sync
CALL IBWRT(receiver%,"CALC2:MARK:FUNC:POW:RES? ACP") 'Query result
CALL IBRD(receiver%, result$)

'----- Read out result -----
Print "Result (CP, ACP low, ACP up, Alt low, Alt up): "
Print result$

```

```
'----- Example 2: Configure CP/ACP manually für GSM -----
result$ = Space$(100)
CALL IBWRT(receiver%,"FREQ:CENT 935.2MHZ")      'Set frequency
CALL IBWRT(receiver%,"CALC:MARK:FUNC:POW:SEL ACP") 'ACP measurement on
CALL IBWRT(receiver%,"SENS:POW:ACH:ACP 1")      '1 adjacent channel
CALL IBWRT(receiver%,"SENS:POW:ACH:BAND 200KHZ") 'Channel band width
CALL IBWRT(receiver%,"SENS:POW:ACH:BAND:ACH 200KHZ")'Adjacent channel bandw.
CALL IBWRT(receiver%,"SENS:POW:ACH:SPAC 200KHZ") 'Channel spacing

CALL IBWRT(receiver%,"SENS:POW:ACH:PRES ACP")   'Optimize settings
CALL IBWRT(receiver%,"SENS:POW:ACH:PRES:RLEV")  'Optimize reference level
CALL IBWRT(receiver%,"SENS:POW:ACH:MODE ABS")   'Absolute measurement
'----- Start measurement and query result -----
CALL IBWRT(receiver%,"INIT;*WAI")              'Sweep with sync
CALL IBWRT(receiver%,"CALC:MARK:FUNC:POW:RES? ACP") 'Query result
CALL IBRD(receiver%, result$)

'----- Read out result -----
Print "Result (CP, ACP low, ACP up): "
Print result$

'----- Active limit check -----
result$ = Space$(100)
CALL IBWRT(receiver%,"CALC:LIM:ACP:ACH 30DB, 30DB") 'Set relative limit
CALL IBWRT(receiver%,"CALC:LIM:ACP:ACH:ABS -35DBM,-35DBM")
                                                    'Set absolute limit

CALL IBWRT(receiver%,"CALC:LIM:ACP:ACH:STAT ON")    'Rel. limit check on
CALL IBWRT(receiver%,"CALC:LIM:ACP:ACH:ABS:STAT ON") 'Abs. limit check on
CALL IBWRT(receiver%,"CALC:LIM:ACP ON")            'Limit check on

'----- Start measurement and query result -----
CALL IBWRT(receiver%,"INIT;*WAI")                  'Sweep with sync
CALL IBWRT(receiver%,"CALC:LIM:ACP:ACH:RES?")      'Query result of
CALL IBRD(receiver%, result$)                      'limit check

'----- Read out result -----
Print "Result Limit Check: ";result$

END SUB

REM *****
```

## Occupied Bandwidth Measurement

In the following example, the bandwidth is to be found in which 95% of the power of a GSM signal is contained. Signal frequency is 935,2 MHz; channel bandwidth is 200 kHz.

```

REM *****
Public Sub OBW()

result$ = Space$(100)

'----- Basic settings -----
CALL SetupStatusReg           'Set status register
CALL IBWRT(receiver%,"*RST")  'Reset instrument
CALL IBWRT(receiver%,"INIT:CONT OFF") 'Single sweep
CALL IBWRT(receiver%,"SYST:DISP:UPD ON") 'ON: display indication on
                                          'OFF: off

'----- Configure receiver for OBW for GSM -----
CALL IBWRT(receiver%,"FREQ:CENT 935.2MHz") 'Set frequency
CALL IBWRT(receiver%,"CALC:MARK:FUNC:POW:SEL OBW") 'OBW measurement on
CALL IBWRT(receiver%,"SENS:POW:ACH:BAND 200KHZ") 'Channel bandwidth
CALL IBWRT(receiver%,"SENS:POW:BWID 95PCT") 'Percentage of power
CALL IBWRT(receiver%,"SENS:POW:ACH:PRES OBW") 'Set frequency and
CALL IBWRT(receiver%,"SENS:POW:ACH:PRES:RLEV") 'optimize level settings
CALL IBWRT(receiver%,"SENS:POW:NCOR OFF") 'Noise correction

'----- Measure and query result -----
CALL IBWRT(receiver%,"INIT;*WAI") 'Sweep with sync
CALL IBWRT(receiver%,"CALC:MARK:FUNC:POW:RES? OBW") 'Query result
CALL IBRD(receiver%, result$)

Print result$

END SUB

REM *****

```



## Time Domain Power Measurement

In the following example the mean carrier power of a signal with 300 kHz bandwidth at 100 MHz is to be determined. In addition, the peak power, the rms value and the standard deviation are measured. To do this, the time-domain-power measurement functions are used.

```

REM *****
Public Sub TimeDomainPower()

result$ = Space$(100)

'----- Basic settings -----
CALL SetupStatusReg           'Set status register
CALL IBWRT(receiver%,"*RST")  'Reset instrument
CALL IBWRT(receiver%,"INIT:CONT OFF") 'Single sweep
CALL IBWRT(receiver%,"SYST:DISP:UPD ON") 'ON: display indication on
                                      'OFF: off

'----- Configure receiver for time domain power measurement -----
CALL IBWRT(receiver%,"FREQ:CENT 100MHz;SPAN 0Hz") 'Set frequency
CALL IBWRT(receiver%,"BAND:RES 300kHz")           'Resolution bandwidth
CALL IBWRT(receiver%,"SWE:TIME 200US")           'Sweep time

CALL IBWRT(receiver%,"CALC:MARK:FUNC:SUMM:PPE ON") 'Pos. Peak measurement
CALL IBWRT(receiver%,"CALC:MARK:FUNC:SUMM:MEAN ON") 'Mean measurement
CALL IBWRT(receiver%,"CALC:MARK:FUNC:SUMM:RMS ON") 'RMS measurement
CALL IBWRT(receiver%,"CALC:MARK:FUNC:SUMM:SDEV ON") 'Standard deviation

'----- Measure and query results -----
CALL IBWRT(receiver%,"INIT;*WAI")                 'Sweep with sync

query$ = " CALC:MARK:FUNC:SUMM:PPE:RES?;"         'Query results:
query$ = query$ + ":CALC:MARK:FUNC:SUMM:MEAN:RES?;" 'Mean measurement
query$ = query$ + ":CALC:MARK:FUNC:SUMM:RMS:RES?;" 'RMS measurement
query$ = query$ + ":CALC:MARK:FUNC:SUMM:SDEV:RES?;" 'Standard deviation
Call IBWRT(receiver%, query$)

CALL IBRD(receiver%, result$)

Print result$

END SUB

REM *****

```

## Reading Trace Data

In the following example the trace data recorded together at the default setting are read out of the instrument and displayed on the screen in the form of a list. Reading is performed consecutively in the binary format and in the ASCII format, at span > 0 and also at span = 0.

In the binary format the message header is evaluated with the length indication and used to calculate the x axis values.

In the ASCII format only the list of level values is output.

The binary data are read out in 3 steps:

1. Reading the number of digits of the length indication
2. Reading the length indication
3. Reading trace data

This procedure is necessary with programming languages that support only structures with similar data types (arrays) (such as Visual Basic) since the data types of header and data differ in binary data.

**Note:** *The dimensions of the arrays for the trace data are chosen in a way that reserves enough space for trace data (501 points).*

```
REM *****
Public Sub ReadTrace()

'----- Define variables -----
Dim traceData(1250) As Single           'Buffer for floating point
                                        'binary data
Dim digits As Byte                     'Number of digits of
                                        'length indication
Dim traceBytes As Integer              'Length of trace data in bytes
Dim traceValues As Integer            'Number of values in buffer
asciiResult$ = Space$(25000)          'Buffer for ASCII trace data
result$ = Space$(100)                 'Buffer for simple results
startFreq$ = Space$(100)              'Buffer for start frequency
span$ = Space$(100)                   'Buffer for span

'----- Basic settings -----
CALL SetupInstrument                   'Basic settings
CALL IBWRT(receiver%,"INIT:CONT OFF") 'Single sweep
CALL IBWRT(receiver%,"INIT;*WAI")     'Sweep with sync

'----- Define span for read out -----
Call ibwrt(receiver%,"FREQ:START?")   'Read out start frequency
Call ibrd(receiver%,startFreq$)
startFreq = Val(startFreq$)

Call ibwrt(receiver%,"FREQ:SPAN?")    'Read out span
Call ibrd(receiver%,span$)
span = Val(span$)
```

```

'----- Read out in binary format -----
Call ibwrt(receiver%, "FORMAT REAL,32")      'Select binary format
Call ibwrt(receiver%, "TRAC1? TRACE1")      'Read out Trace 1
Call ilrd(receiver%, result$, 2)            'Read out and store
digits = Val(Mid$(result$, 2, 1))           'number of digits of
                                             'length indication
result$ = Space$(100)                       'Initialize buffer again
Call ilrd(receiver%, result$, digits)        'Read out
traceBytes = Val(Left$(result$, digits))     'and store indication of length
Call ibrd32(receiver%, traceData(0), traceBytes) 'Read trace data into buffer
Call ilrd(receiver%, result$, 1)           'Read the terminator <NL>
'----- Read out binary data as pairs of frequency/level values -----
traceValues = traceBytes/4                  'Single precision = 4 bytes
stepsize = span/traceValues                 'Calculate frequency step width
For i = 0 To traceValues - 1
    Print "Value["; i; "] = "; startFreq+stepsize*i; ", "; traceData(i)
Next i
'----- Basic settings time domain -----
Call ibwrt(receiver%, "FREQ:SPAN 0Hz")      'Zero span on
CALL IBWRT(receiver%, "INIT;*WAI")         'Sweep with sync
'----- Read out in ASCII format -----
Call ibwrt(receiver%, "FORMAT ASCII")       'Select ASCII format
CALL ibwrt(receiver%, "TRAC1? TRACE1")     'Read out Trace 1
CALL ibrd(receiver%, asciiResult$)
Print "Contents of Tracel: ", asciiResult$
END SUB
REM *****

```

## Storing and Loading Device Settings

### Storing Instrument Settings

In the following example the settings/measurement data to be stored are determined; only the hardware settings are stored. The selection commands for the other settings are indicated with the status OFF for the sake of completeness.

```

REM *****
Public Sub StoreSettings()

'----- Basic settings -----
Call SetupInstrument
CALL IBWRT(receiver%,"INIT:CONT OFF")           'Single sweep
CALL IBWRT(receiver%,"INIT;*WAI")              'Sweep with sync

'----- Select items to store -----
CALL IBWRT(receiver%,"MMEM:SEL:HWS ON")         'Select hardware settings to
                                                'store
CALL IBWRT(receiver%,"MMEM:SEL:TRAC OFF")       'Disable traces to store
CALL IBWRT(receiver%,"MMEM:SEL:LIN:ALL OFF")   'Select active limit lines to
                                                'store

'----- Define comment -----
CALL IBWRT(receiver%,"MMEM:COMM 'Test Setup'")

'----- Store selected items -----
CALL IBWRT(receiver%,"MMEM:STOR:STAT 1,'D:\USER\DATA\TEST1'")

'----- Reset instrument -----
CALL IBWRT(receiver%,"*RST")

END SUB
REM *****

```

## Loading Device Settings

In the following example data set "TEST1" stored under D:\USER\DATA is reloaded into the instrument:

```

REM *****
Public Sub LoadSettings()

'----- Set status registers -----
'This subroutine loads data set "TEST1" in directory D:\USER\DATA.
'-----
Call SetupStatusReg           'Set status register
'----- Load data set -----
CALL IBWRT(receiver%,"MMEM:LOAD:STAT 1,'D:\USER\DATA\TEST1'")
'----Start measurement with the settings of the loaded data set -----
CALL IBWRT(receiver%,"DISP:TRAC1:MODE WRITE") 'Set trace to Clr/Write
CALL IBWRT(receiver%,"INIT;*WAI")           'Start the sweep
END SUB
REM *****

```

## Setting the Data Set for Startup Recall

In the following example the receiver is first reset. Then the data set TEST1 stored under D:\USER\DATA is selected for the function STARTUP RECALL, ie the data set is set for every \*RST, PRESET and every device startup. For illustration, the command \*RST is executed again.

```

REM *****
Public Sub StartupRecallSettings()
'----- Reset receiver -----
CALL IBWRT(receiver%,"*RST")
'----- Set status registers -----
Call SetupStatusReg           'Set status register
'----- Select startup recall data set-----
CALL IBWRT(receiver%,"MMEM:LOAD:AUTO 1,'D:\USER\DATA\TEST1'")
'----- Activate startup recall data set -----
CALL IBWRT(receiver%,"*RST")
END SUB
REM *****

```

## Reading and Writing Files

### Reading a File from the Instrument

In the following example file TEST1.SET stored under D:\USER\DATA is read from the instrument and stored in the controller.

```

REM *****
Public Sub ReadFile()
'----- Variables -----
Dim digits As Byte           'Number of digits of
                             'length indication
Dim fileBytes As Long        'Length of file with trace data
                             'in bytes
result$ = Space$(100)        'Buffer for simple results
'----- Basic settings status registers -----
Call SetupStatusReg          'Set status register
'----- Read out file -----
Call ibwrt(receiver%, "MMEM:DATA? 'D:\USER\DATA\TEST1.SET'")
                             'Select file
Call ilrd(receiver%, result$, 2)
                             'Read and store number of
                             'digits in length
digits = Val(Mid$(result$, 2, 1))
                             'indication
Call ilrd(receiver%, result$, digits)
                             'Read and store length
fileBytes = Val(Left$(result$, digits))
                             'indication
FileBuffer$ = Space$(fileBytes)
                             'Buffer for file
Call ilrd(receiver%, FileBuffer, fileBytes)
                             'Read file into buffer
Call ilrd(receiver%, result$, 1)
                             'Read terminator <NL>
'----- Store file to controller -----
Open "TEST1.SET" For Output As #1
Print #1, FileBuffer;
                             ' ; to avoid linefeed at
                             ' end of file

Close #1
END SUB
REM *****

```

## Creating a File in the Instrument

In the following example file TEST1.SET available on the controller is stored in the instrument under D:\USER\DATA\DUPLICAT.SET.

```

REM *****
Public Sub WriteFile()
  '----- Variables -----
  FileBuffer$ = Space$(100000)           'Buffer for file
  Dim digits As Long                     'Number of digits of
                                          'length indication
  Dim fileBytes As Long                  'Length of file in bytes
  fileSize$ = Space$(100)               'Length of file in a string
  result$ = Space$(100)                  'Buffer for simple results

  '----- Basic settings status registers -----
  Call SetupStatusReg                    'Set status register

  '----- Prepare the definite length block data -----
  fileBytes = FileLen("H:\work\vb\test1.set") 'Determine length of file
  fileSize$ = Str$(fileBytes)
  digits = Len(fileSize$) - 1            'Determine number of digits of
  fileSize$ = Right$(fileSize$, digits)  'length indication
  FileBuffer$ = "#" + Right$(Str$(digits), 1) + fileSize$
                                          'Put length indication into
                                          'file buffer

  '----- Read file from controller -----
  Open "H:\work\vb\TEST1.SET" For Binary As #1
  FileBuffer$ = FileBuffer$ + Left$(Input(fileBytes, #1), fileBytes)
  Close #1

  '----- Write file -----
  -
  Call ibwrt(receiver%, "SYST:COMM:GPIB:RTER EOI") 'Set receive
                                                    'terminator in the
                                                    'instrument

  Call ibwrt(receiver%, "MMEM:DATA 'D:\USER\DATA\DUPLICAT.SET', " +
                        FileBuffer$)              'Select file

END SUB
REM *****

```

## Configuring and Starting a Printout

The following example shows the configuration of the output format and output device for printing out a measurement mask.

The procedure is in the following order:

1. Set the measurement required for the printout
2. Query available output devices
3. Select an output device
4. Select the output interface
5. Configure the output format
6. Start printout with synchronization to the end

It is assumed that the setting required is a signal with a power of  $-20$  dBm at 100 MHz and also that the printer required is the 6<sup>th</sup> of the available printers. The printout is first performed to the selected printer, then to a file.

```

REM *****
Public Sub HCopy()

DIM Devices(100) as string           'Buffer for printer name
FOR i = 0 TO 49
    Devices$(i) = Space$(50)         'Preallocate buffer for
                                     'printer name
NEXT i

'----- Basic settings -----
CALL SetupStatusReg                 'Set status register
CALL IBWRT(receiver%,"*RST")        'Reset instrument
CALL IBWRT(receiver%,"INIT:CONT OFF") 'Single sweep
CALL IBWRT(receiver%,"SYST:DISP:UPD ON") 'Display indication on

'----- Configure measurement -----
CALL IBWRT(receiver%,"FREQ:CENT 100MHz;SPAN 10MHz") 'Set frequency
CALL IBWRT(receiver%,"DISP:WIND:TRAC:Y:RLEV -10dBm") 'Reference level
CALL IBWRT(receiver%,"INIT;*WAI") 'Start measurement

'----- Query available output devices -----
CALL IBWRT(receiver%,"SYST:COMM:PRIN:ENUM:FIRSt?") 'Read out first
CALL IBRD(receiver%,Devices$(0)) 'printer and indicate
PRINT "Drucker 0: "+Devices$(0) 'printer name

For i = 1 to 99
    CALL IBWRT(receiver%,"SYST:COMM:PRIN:ENUM:NEXT?") 'Read out the next
    CALL IBRD(receiver%,Devices$(i)) 'printer name
    IF Left$(Devices$(i),2) = "" THEN GOTO SelectDevice 'Abort at end of
                                                         'list
    PRINT "Drucker"+Str$(i)+" : " Devices$(i) 'Indicate printer name
NEXT i

```



SelectDevice:

```
'----- Select device, printer language and interface -----
CALL IBWRT(receiver%,"SYST:COMM:PRIN:SEL "+ Devices(6))'Select printer #6
8 CALL IBWRT(receiver%,"HCOP:DEST 'SYST:COMM:PRIN'") 'Configuration:
'Print out to
'printer interface"

CALL IBWRT(receiver%,"HCOP:DEV:LANG GDI") 'Output language 'GDI'

'----- Select orientation (portrait/landscape) and color/BW -----
CALL IBWRT(receiver%,"HCOP:PAGE:ORI PORTRait") 'Portrait
CALL IBWRT(receiver%,"HCOP:DEV:COL OFF") 'Black and white

'----- Configure and start print out -----
CALL IBWRT (receiver%,"HCOP:ITEM:ALL") 'Select complete screen
'CALL IBWRT (receiver%,"HCOP:ITEM:WIND1:TRAC:STAT ON") 'alternative: only
'CALL IBWRT (receiver%,"HCOP:ITEM:WIND2:TRAC:STAT ON") 'traces in
' screen A/B

CALL IBWRT (receiver%,"*CLS") 'Reset status registers
CALL IBWRT (receiver%,"HCOP:IMMediate;*OPC") 'Start print out

CALL WaitSRQ(boardID%,result%) 'Wait for service request
IF (result% = 1) THEN CALL Srq 'If SRQ is recognized =>
'Subroutines for evaluation

'----- Print out into file in WMF format (BMP format) -----
CALL IBWRT(receiver%,"HCOP:DEST 'MMEM'") 'Configuration:
'"Print to file"

CALL IBWRT(receiver%,"HCOP:DEV:LANG WMF") 'File format WMF
'CALL IBWRT(receiver%,"HCOP:DEV:LANG BMP") 'File format BMP

CALL IBWRT(receiver%,"MMEM:NAME 'D:\USER\DATA\PRINT1.WMF'") 'Determine
'file name

CALL IBWRT (receiver%,"*CLS") 'Reset status registers
CALL IBWRT (receiver%,"HCOP:IMMediate;*OPC") 'Start print out

CALL WaitSRQ(boardID%,result%) 'Wait for service request
IF (result% = 1) THEN CALL Srq 'If SRQ is recognized =>
'Subroutines for evaluation

END SUB

REM *****
```

## Contents - Chapter 8 "Maintenance and Instrument Interfaces"

<b>8 Maintenance and Instrument Interfaces .....</b>	<b>8.1</b>
<b>Maintenance .....</b>	<b>8.1</b>
Mechanical and Electrical Maintenance .....	8.1
Storing and Packing.....	8.1
List of Power Cables Available .....	8.1
<b>Instrument Interfaces .....</b>	<b>8.2</b>
AF Output .....	8.2
Probe Connector (PROBE POWER).....	8.2
External Keyboard (KEYBOARD) .....	8.2
IEC Bus Interface .....	8.3
Interface Characteristics.....	8.3
Bus Lines 8.3	
Interface Functions .....	8.4
IEC Bus Messages.....	8.4
Interface Messages .....	8.5
Instrument Messages .....	8.5
Printer Interface (LPT) .....	8.6
RS-232-C Interface (COM).....	8.7
Interface Characteristics.....	8.7
Signal Lines.....	8.7
Transmission Parameters .....	8.8
Control Characters .....	8.9
Handshake .....	8.9
User Interface (USER).....	8.10
Monitor Connector (MONITOR).....	8.11
Noise Source Control (NOISE SOURCE) .....	8.11
External Trigger Input (EXT TRIG/GATE) .....	8.11
Mouse Connector (MOUSE).....	8.11
Reference Output/Input (REF IN and REF OUT) .....	8.12
IF Output 20.4 MHz (20.4 MHz OUT) .....	8.12
CCVS Input and Output (CCVS IN/OUT, Option FSP-B6) .....	8.12
Input for External Modulation of Tracking Generator (TG I / AM IN; TG Q / FM IN) (Option FSP-B9) .....	8.12
LAN - Connector (Option FSP-B16) .....	8.12



## 8 Maintenance and Instrument Interfaces

The ESPI following chapter contains information on the maintenance of the ESPI and on the instrument interfaces.

Please follow the instructions in the service manual when exchanging modules or ordering spares. The order no. for spare parts can be found in the service manual.

The address of our support center and a list of all Rohde & Schwarz service centers can be found at the beginning of this manual.

The service manual includes further information particularly on troubleshooting, repair, exchange of modules (including battery exchange, adjustment of the OCXO oscillator) and calibration.

### Maintenance

#### Mechanical and Electrical Maintenance

The ESPI does not require any special maintenance. Remove any contamination on the instrument by means of a soft cloth. Make sure that the air vents are not obstructed.

#### Storing and Packing

The ESPI can be stored at a temperature of  $-5^{\circ}\text{C}$  to  $+60^{\circ}\text{C}$ . When stored for an extended period of time the instrument should be protected against dust.

The original packing should be used, particularly the protective covers at the front and rear, when the instrument is to be transported or dispatched. If the original packing is no longer available, use a sturdy cardboard box of suitable size and carefully wrap the instrument to protect it against mechanical damage.

#### List of Power Cables Available

Table 8-1 List of power cables available

Stock No.	Earthed-contact connector	Preferably used in
DS 006.7013	BS1363: 1967' complying with IEC 83: 1975 standard B2	Great Britain
DS 006.7020	Type 12 complying with SEV-regulation 1011.1059, standard sheet S 24 507	Switzerland
DS 006.7036	Type 498/13 complying with US-regulation UL 498, or with IEC 83	USA/Canada
DS 006.7107	Type SAA3 10 A, 250 V, complying with AS C112-1964 Ap.	Australia
DS 0025.2365 DS 0099.1456	DIN 49 441, 10 A, 250 V, angular DIN 49 441, 10 A, 250 V, straight	Europe (except Switzerland)

## Instrument Interfaces

### AF Output

A miniature telephone jack can be used at the AF OUTPUT connector to connect an external loudspeaker, a headphone set or, e.g., a LF voltmeter. The internal resistance is 10 ohms and the output voltage can be controlled with the volume controller on the left side to the connector. When a jack is plugged in, the internal loudspeaker is automatically turned off.



### Probe Connector (PROBE POWER)

To allow the connection of probes, the ESPI provides the PROBE POWER power connector. It delivers the power supply voltages +15 V and -12,6 V and ground.

The connector is also suited for powering the high-impedance probes from Hewlett Packard.

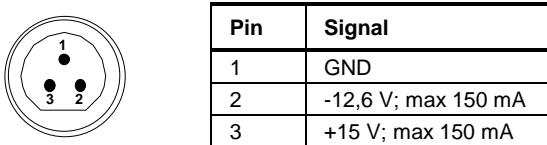

Fig. 8-1 Pin assignments of PROBE POWER connector

To allow the connection of R&S accessories, the ESPI also offers the 5-pole PROBE POWER connector which delivers the power supply voltages  $\pm 10$  V and ground. An adapter to connect a 12-pin Tüchel connector is provided with the instrument.

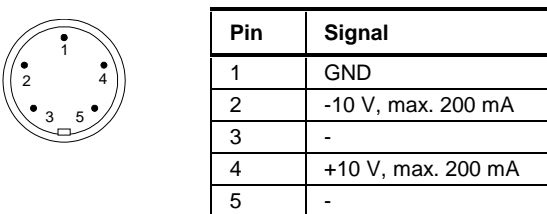

Fig. 8-2 Pin assignments of PROBE POWER connector

### External Keyboard (KEYBOARD)

A 6-pin PS/2 connector is provided on the front panel to allow connecting an external keyboard. The PSP-Z1 keyboard (Order No. 1091.4000.02, german) or the PSP-Z2 (Order No. 1091.4100.02, english) is recommended (Order No. 1009.5001.31). Also they include a trackball for mouse control. However, any other multi-function keyboard may also be used.

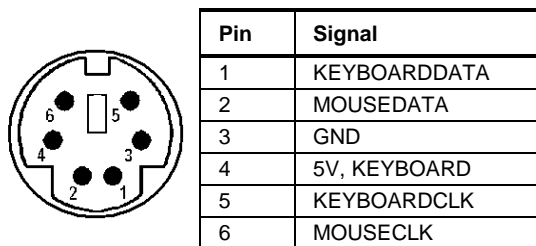

Fig 8-3 Pin assignments of the KEYBOARD connector.

## IEC Bus Interface

The standard instrument is equipped with an IEC/IEEE Bus connector. An IEEE 488 interface connector is located on the rear panel of the ESPI. An external controller for remote control of the instrument can be connected via the IEEE 488 interface connector using a shielded cable.

### Interface Characteristics

- 8-bit parallel data transfer
- bi-directional data transfer
- three-line handshake
- high data transfer rate of max. 350 kbyte/s
- up to 15 instruments can be connected
- maximal length of the interconnecting cables 15 m (single connection, 2m)
- wired-OR connection if several instruments are connected in parallel.

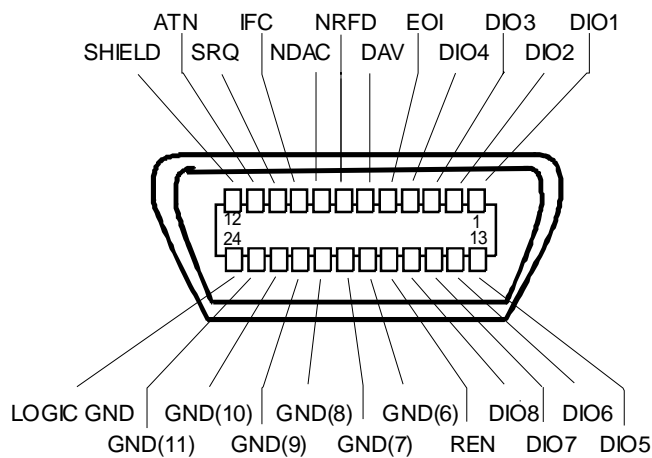

Fig. 8-4 Pin assignment of IEC-Bus interface

### Bus Lines

#### 1. Data bus with 8 lines DIO 1 to DIO 8.

The transmission is bit-parallel and byte-serial in the ASCII/ISO code. DIO1 is the least significant, DIO8 the most significant bit.

#### 2. Control bus with 5 lines.

**IFC** (Interface Clear),

active low resets the interfaces of the devices connected to the default setting.

**ATN** (Attention),

active low signals the transmission of interface messages

inactive high signals the transmission of device messages.

**SRQ (Service Request),**

active low enables a device connected to send a service request to the controller.

**REN (Remote Enable),**  
active low permits the switch over to remote control.

**EOI (End or Identify),**  
has two functions in connection with ATN:  
active low marks the end of data transmission when ATN=high  
active low triggers a parallel poll when ATN=low.

### 3. Handshake bus with three lines.

**DAV (Data Valid),**  
active low signals a valid data byte on the data bus.

**NRFD (Not Ready For Data),**  
active low signals that one of the devices connected is not ready for data transfer .

**NDAC (Not Data Accepted),**  
active low as long as the device connected is accepting the data present on the data bus.

## Interface Functions

Instruments which can be remote controlled via the IEC bus can be equipped with different interface functions. Table 8-2 lists the interface functions appropriate for the instrument.

Table 8-2 Interface functions

Control character	Interface function
SH1	Handshake source function (source handshake), full capability
AH1	Handshake sink function (acceptor handshake), full capability
L4	Listener function, full capability, deaddressed by MTA.
T6	Talker function, full capability, ability to respond to serial poll, deaddressed by MLA
SR1	Service request function (Service Request), full capability
PP1	Parallel poll function, full capability
RL1	Remote/Local switch over function, full capability
DC1	Reset function (Device Clear), full capability
DT1	Trigger function (Device Trigger), full capability
C0	No controller function

## IEC Bus Messages

The messages transferred via the data lines of the IEC bus can be divided into two groups:

- **interface messages** and
- **instrument messages.**

## Interface Messages

Interface messages are transferred on the data lines of the IEC Bus when the "ATN" control line is active (LOW). They are used for communication between controller and instruments and can only be sent by the controller which currently has control of the IEC Bus.

### Universal Commands

The universal commands are encoded 10 - 1F hex. They affect all instruments connected to the bus without addressing.

Table 8-3 Universal Commands

Command	QuickBASIC command	Effect on the instrument
DCL (Device Clear)	IBCMD (controller%, CHR\$(20))	Aborts the processing of the commands just received and sets the command processing software to a defined initial state. Does not change the instrument settings.
IFC (Interface Clear)	IBSIC (controller%)	Resets the interfaces to the default setting.
LLO (Local Lockout)	IBCMD (controller%, CHR\$(17))	The LOC/IEC ADDR key is disabled.
SPE (Serial Poll Enable)	IBCMD (controller%, CHR\$(24))	Ready for serial poll.
SPD (Serial Poll Disable)	IBCMD (controller%, CHR\$(25))	End of serial poll.
PPU (Parallel Poll Unconfigure)	IBCMD (controller%, CHR\$(21))	End of the parallel-poll state.

### Addressed Commands

The addressed commands are encoded 00 - 0F hex. They are only effective for instruments addressed as listeners.

Table 8-4 Addressed Commands

Command	QuickBASIC command	Effect on the instrument
SDC (Selected Device Clear)	IBCLR (device%)	Aborts the processing of the commands just received and sets the command processing software to a defined initial state. Does not change the instrument setting.
GTL (Go to Local)	IBLOC (device%)	Transition to the "Local" state (manual control).
PPC (Parallel Poll Configure)	IBPPC (device%, data%)	Configure instrument for parallel poll. Additionally, the QuickBASIC command executes PPE/PPD.

## Instrument Messages

Instrument messages are transferred on the data lines of the IEC bus when the "ATN" control line is not active. ASCII code is used.

Structure and syntax of the instrument messages are described in Chapter 5. The commands are listed and explained in detail in Chapter 6.



## Printer Interface (LPT)

The 25-pin LPT connector on the rear panel of the Fig. 8-5 is provided for the connection of a printer. The LPT interface is compatible with the CENTRONICS printer interface.

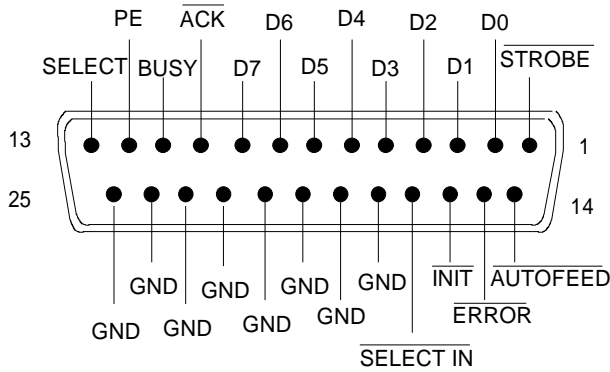

Pin	Signal	Input (I) Output (O)	Description
1	STROBE	O	Pulse for transmitting a data byte, min. 1µs pulse width (active LOW)
2	D0	O	Data Line 0
3	D1	O	Data Line 1
4	D2	O	Data Line 2
5	D3	O	Data Line 3
6	D4	O	Data Line 4
7	D5	O	Data Line 5
8	D6	O	Data Line 6
9	D7	O	Data Line 7
10	ACK	I	Indicates that the printer is ready to receive the next byte. (active LOW)
11	BUSY	I	Signal is active when the printer cannot accept data. (active HIGH)
12	PE	I	Signal is active when the paper tray is empty. (active HIGH)
13	SELECT	I	Signal is active when the printer is selected. (active HIGH)
14	AUTOFEED	O	When signal is active, the printer automatically performs a linefeed after each line. (active LOW)
15	ERROR	I	This signal is high when the printer has no paper, is not selected or has an error status. (active LOW)
16	INIT	O	Initialize the printer. (active LOW)
17	SELECT IN	O	If signal is active, the codes DC1/DC3 are ignored by the printer. (active LOW).
18 - 25	GND		Ground connection.

Fig. 8-5 Pin assignments for the LPT connector.

## RS-232-C Interface (COM)

The standard ESPI is equipped with a serial interfaces (RS-232-C; COM connector at the rear of the instrument). The interface can be set up and activated manually in the *SETUP-GENERAL SETUP* menu in the *COM PORT* table (Selection *OWNER = INSTRUMENT*).

### Interface Characteristics

- Serial data transmission in asynchronous mode
- Bi-directional data transfer via two separate lines
- Transmission rate selectable from 110 to 19200 baud
- Logic '0' signal from +3 V to +15 V
- Logic '1' signal from -15 V to -3 V
- An external instrument (controller) can be connected.

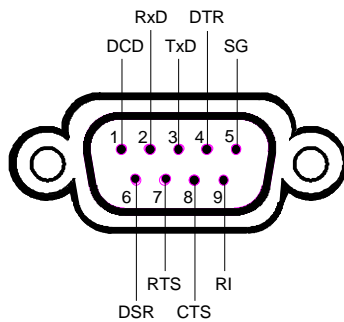

Fig. 8-6 Pin assignment of the RS-232-C interface

### Signal Lines

#### DCD (Data Carrier Detect),

*Not used in ESPI.*

Input; active LOW.

Using this signal, the local terminal recognizes that the modem of the remote station receives valid signals with sufficient level. DCD is used to disable the receiver in the local terminal and prevent reading of false data if the modem cannot interpret the signals of the remote station.

#### RxD (Receive Data)

Input, LOW = logic '1', HIGH = logic '0'.

Data line, local terminal receives data from remote station.

#### TxD (Transmit Data)

Output, LOW = logic '1', HIGH = logic '0'.

Data line, local terminal transmits data to remote station.

#### DTR (Data Terminal Ready),

Output, active LOW,

Indicates that the local terminal is ready to receive data.

#### GND

Interface ground, connected to instrument ground

**DSR** (Data Set Ready),  
Input, active LOW,  
Indicates that the remote station is ready to receive data.

**RTS** (Request To Send),  
Output, active LOW.  
Indicates that the local terminal wants to transmit data.

**CTS** (Clear To Send),  
Input, active LOW.  
Used to tell the local terminal that the remote station is ready to receive data.

**RI** (Ring Indicator),  
*Not used in ESPI.*  
Input, active LOW.  
Used by a modem to indicate that a remote station wants to establish a connection.

## Transmission Parameters

To ensure error-free data transmission, the parameters of the instrument and the controller must have the same settings. The parameters are defined in the *SETUP-GENERAL SETUP* menu.

**Transmission rate (baud rate)**      the following transmission rates can be set in the instrument:  
110, 300, 600, 1200, 2400, 4800, 9600, 19200.

**Data bits**      Data transmission is in 7- or 8-bit ASCII code. The first bit transmitted is the LSB (least significant bit).

**Start bit**      Each data byte starts with a start bit. The falling edge of the start bit indicates the beginning of the data byte.

**Parity bit**      In order to detect errors, a parity bit may be transmitted. No parity, even parity or odd parity may be selected. In addition, the parity bit can be set to logic '0' or to logic '1'.

**Stop bits**      The transmission of a data byte is terminated by 1, 1,5 or 2 stop bits.

### Example:

Transmission of character 'A' (41 hex) in 7-bit ASCII code, with even parity and 2 stop bits:

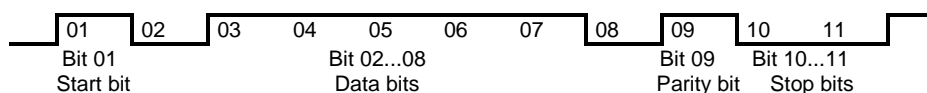

### Control Characters

For interface control, several strings are defined and control characters are reserved which are based upon IEC Bus control.

Table 8-5 Control strings or control characters of the RS-232 interface

Control string or character	Function
'@REM'	Switch over to remote
'@LOC'	Switch over to local
'@SRQ'	Service Request SRQ ( SRQ is sent by the instrument)
'@GET'	Group Execute Trigger (GET)
'@DCL'	Reset instrument (Device Clear DCL)
<Ctrl Q> 11 Hex	Enables character output / XON
<Ctrl S> 13 Hex	Inhibits character output / XOFF
0D Hex, 0A Hex	Terminator <CR>, <LF>

### Handshake

#### Software handshake

In the software handshake mode of operation, the data transfer is controlled using the two control characters XON / XOFF.

The instrument uses the control character XON to indicate that it is ready to receive data. If the receive buffer is full, it sends the XOFF character via the interface to the controller. The controller then interrupts the data output until it receives another XON from the instrument. The controller indicates to the instrument that it is ready to receive data in the same way.

#### Cable required for software handshake

The connection of the instrument with a controller for software handshake is made by crossing the data lines. The following wiring diagram applies to a controller with a 9-pin or 25-pin configuration.

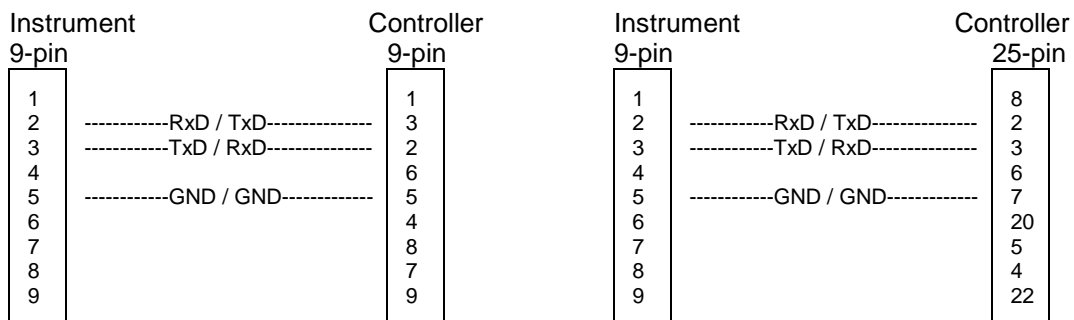

Fig. 8-7 Wiring of the data lines for software handshake

**Hardware handshake**

For hardware handshake, the instrument indicates that it is ready to receive data via the lines DTR and RTS. A logic '0' on both lines means 'ready' and a logic '1' means 'not ready'. The RTS line is always active (logic '0') as long as the serial interface is switched on. The DTR line thus controls the readiness of the instrument to receive data.

The readiness of the remote station to receive data is reported to the instrument via the CTS and DSR line. A logic '0' on both lines activates the data output and a logic '1' on both lines stops the data output of the instrument. The data output takes place via the TxD line.

**Cable for hardware handshake**

The connection of the instrument to a controller is made with a so-called zero modem cable. Here, the data, control and acknowledge lines must be crossed. The following wiring diagram applies to a controller with a 9-pin or 25-pin configuration.

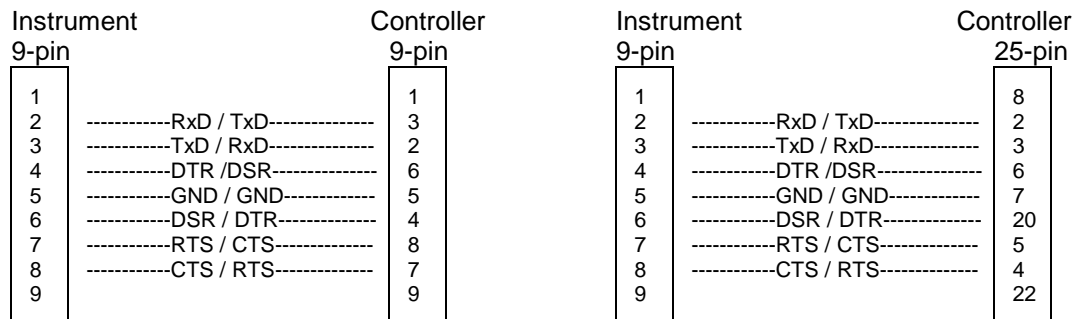

Fig. 8-8 Wiring of the data, control and acknowledge lines for hardware handshake

**User Interface (USER)**

The user interface, located on the rear panel of the ESPI, is a 25 pin Cannon connector which provides access to the user ports (Port A). The port is 8 bits wide (A0 - A7) and can be configured either as output or as input. The voltage levels are TTL levels (Low < 0,4 V, High > 2 V).

In addition, an internal +5 V power supply voltage is provided. The maximum load current is 100 mA. The pin assignments for the USER connector can be seen in the following diagram:

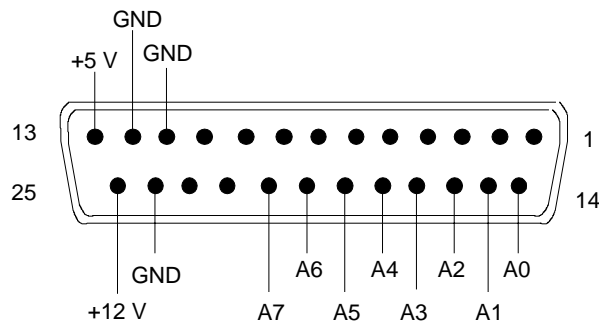
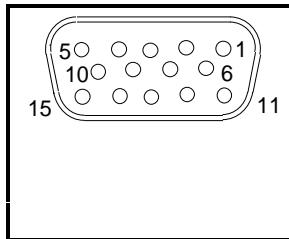

Fig. 8-9 Pin assignments for the USER connector.

The configuration of the user ports takes place in the *SETUP* menu (SETUP key) in the *GENERAL SETUP* sub-menu.

## Monitor Connector (MONITOR)



Pin	Signal	Pin	Signal	Pin	Signal
1	R	6	GND	11	(NC)
2	G	7	GND	12	(NC)
3	B	8	GND	13	HSYNC
4	(NC)	9	GND	14	VSYNC
5	GND	10	GND	15	(NC)

Fig. 8-10 Pin assignments of the MONITOR connector.

## Noise Source Control (NOISE SOURCE)

Using the NOISE SOURCE connector, an external noise source can be switched on/off, in order, e.g., to measure the noise figure of Units Under Test (UUTs). Usual noise sources require a +28 V signal to be turned on. At 0 V, they are turned off. These supply voltages are delivered by the connector. Maximum current is 100 mA..

## External Trigger Input (EXT TRIG/GATE)

The EXT TRIG/GATE connector is used for controlling the measurement via an external signal. The trigger voltages are TTL level (Low < 0.7 V, High > 1.4 V), typ. input impedance is 10 kOhm

## Mouse Connector (MOUSE)

A PS/2 connector is provided at the rear panel to connect a PS/2 mouse:

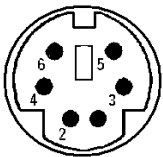

Pin	Signal
1	MOUSEDATA
2	KEYBOARDDATA
3	MOUSEGND
4	MOUSEVDS
5	MOUSECLK
6	KEYBOARDCLK

Fig 8-11 Pin assignments for the MOUSE connector.

## Reference Output/Input (REF IN and REF OUT)

For operation with an external reference, the internal reference oscillator is then synchronized to the 10-MHz reference applied to the connector. The necessary level is  $> 0$  dBm.

The internal 10 MHz reference signal is also available at the REF OUT connector and thus provides the capability of, e.g., synchronization of external instruments to the ESPI. The output level is 0 dBm.

Selection between internal and external reference is possible in the *SETUP* menu.

## IF Output 20.4 MHz (20.4 MHz OUT)

The 20,4 MHz IF signal of the ESPI is available at the 20.4 MHz OUT BNC connector. The bandwidth corresponds to the selected bandwidth for a resolution bandwidth between 100 kHz and 10 MHz. For a resolution bandwidth below 100 kHz, the bandwidth of the output is 2.6 times the resolution bandwidth with a minimum of 2.6 kHz.

The signal level at the IF output is 0 dBm for resolution bandwidth  $\geq 100$  kHz, and  $-10$  dBm for resolution bandwidth  $< 100$  kHz (mixer level  $\geq 60$  dBm) .

**Note:** *This output is replaced by connector CCVS IN/OUT if option FSP-B6 is built in.*

## CCVS Input and Output (CCVS IN/OUT, Option FSP-B6)

The BNC connector CCVS IN/OUT can be switched at CCVS input or CCVS output. If TV triggering is switched on, the demodulated TV signal is available for operating a CCVS monitor, provided triggering is set to the internal demodulation signal (CCVS INT). In case of TV triggering to an externally fed CCVS signal (CCVS EXT), the connector serves as an input.

## Input for External Modulation of Tracking Generator (TG I / AM IN; TG Q / FM IN) (Option FSP-B9)

The BNC connectors TG I /AM IN and TG Q /FM IN are used for external modulation of the tracking generator (option FSP-B9) by an external signal.

The input level range at the is  $\pm 0.5$  V, the input impedance is 50 Ohm.

## LAN - Connector (Option FSP-B16)

The LAN connector allows to connect the ESPI to a local area network. The RJ-45 connector is designed to support star topology 2-pair Category 5 UTP/STP cables. UTP stands for "Unshielded Twisted-Pair" cables, while STP stands for "Shielded Twisted-Pair".

## Contents - Chapter 9 "Error Messages"

### 9 Error Messages

SCPI-Specific Error Messages.....	9.2
Device-Specific Messages .....	9.8





## 9 Error Messages

Error messages are entered in the error/event queue of the status reporting system in the remote control mode and can be queried with the command `SYSTem:ERRor?`. The answer format of ESPI to the command is as follows:

```
<error code>, "<error text with queue query>;  
<remote control command concerned>"
```

The indication of the remote control command with prefixed semicolon is optional.

Example:

The command `"TEST:COMMAND"` generates the following answer to the query `SYSTem:ERRor?` :

```
-113,"Undefined header;TEST:COMMAND"
```

The subsequent list contains the description of error texts displayed on the instrument.

Distinction is made between error messages defined by SCPI, which are marked by negative error codes, and the device-specific error messages for which positive error codes are used.

The right-hand column in the following tables contains the error text in bold which is entered in the error/event queue and can be read out by means of query `SYSTem:ERRor?`. A short explanation of the error cause is given below. The left-hand column contains the associated error code.

## SCPI-Specific Error Messages

No Error

Error code	Error text in the case of queue poll Error explanation
0	<b>No error</b> This message is output if the error queue does not contain any entries.

Command Error - Faulty command; sets bit 5 in the ESR register.

Error code	Error text in the case of queue poll Error explanation
-100	<b>Command Error</b> The command is faulty or invalid.
-101	<b>Invalid Character</b> The command contains an invalid sign. Example: A header contains an ampersand, " <b>SENSe&amp;</b> ".
-102	<b>Syntax error</b> The command is invalid. Example: The command contains block data the instrument does not accept.
-103	<b>Invalid separator</b> The command contains an imallowed sign instead of a separator. Example: A semicolon is missing after the command.
-104	<b>Data type error</b> The command contains an invalid value indication. Example: ON is indicated instead of a numeric value for frequency setting.
-105	<b>GET not allowed</b> A Group Execute Trigger (GET) is within a command line.
-108	<b>Parameter not allowed</b> The command contains too many parameters. Example: Command <b>SENSe:FREQuency:CENTer</b> permits only one frequency indication.

## Continuation: Command Error

Error code	Error text in the case of queue poll Error explanation
-109	<b>Missing parameter</b> The command contains too few parameters. Example: The command <code>SENSe:FREQuency:CENTer</code> requires a frequency indication.
-110	<b>Command header error</b> The header of the command is faulty.
-111	<b>Header separator error</b> The header contains an imallowed separator. Example: the header is not followed by a "White Space", " <code>*ESE255</code> "
-112	<b>Program mnemonic too long</b> The header contains more than 12 characters.
-113	<b>Undefined header</b> The header is not defined for the instrument. Example: <code>*XYZ</code> is undefined for every instrument.
-114	<b>Header suffix out of range</b> The header contains an imallowed numeric suffix. Example: <code>SENSe3</code> does not exist in the instrument.
-120	<b>Numeric data error</b> The command contains a faulty numeric parameter.
-121	<b>Invalid character in number</b> A number contains an invalid character. Example: An "A" in a decimal number or a "9" in an octal number.
-123	<b>Exponent too large</b> The absolute value of the exponent is greater than 32000.
-124	<b>Too many digits</b> The number includes too many digits.
-128	<b>Numeric data not allowed</b> The command includes a number which is not allowed at this position. Example: The command <code>INPut:COUPLing</code> requires indication of a text parameter.
-130	<b>Suffix error</b> The command contains a faulty suffix.
-131	<b>Invalid suffix</b> The suffix is invalid for this instrument. Example: nHz is not defined.
-134	<b>Suffix too long</b> The suffix contains more than 12 characters.
-138	<b>Suffix not allowed</b> A suffix is not allowed for this command or at this position of the command. Example: The command <code>*RCL</code> does not permit a suffix to be indicated.
-140	<b>Character data error</b> The command contains a faulty text parameter
-141	<b>Invalid character data</b> The text parameter either contains an invalid character or it is invalid for this command. Example: Write error with parameter indication; <code>INPut:COUPLing XC</code> .

Continuation: Command Error

Error code	Error text in the case of queue poll Error explanation
-144	<b>Character data too long</b> The text parameter contains more than 12 characters.
-148	<b>Character data not allowed</b> The text parameter is not allowed for this command or at this position of the command. Example: The command <b>*RCL</b> requires a number to be indicated.
-150	<b>String data error</b> The command contains a faulty string.
-151	<b>Invalid string data</b> The command contains a faulty string. Example: An END message has been received prior to the terminating apostrophe.
-158	<b>String data not allowed</b> The command contains a valid string at a position which is not allowed. Example: A text parameter is set in quotation marks, <b>INPut:COUPLing "DC"</b>
-160	<b>Block data error</b> The command contains faulty block data.
-161	<b>Invalid block data</b> The command contains faulty block data. Example: An END message was received prior to reception of the expected number of data.
-168	<b>Block data not allowed</b> The command contains valid block data at an imallowed position. Example: The command <b>*RCL</b> requires a number to be indicated.
-170	<b>Expression error</b> The command contains an invalid mathematical expression.
-171	<b>Invalid expression</b> The command contains an invalid mathematical expression. Example: The expression contains mismatching parentheses.
-178	<b>Expression data not allowed</b> The command contains a mathematical expression at an imallowed position.

Execution Error - Error on execution of a command; sets bit 4 in the ESR register

Error code	Error text in the case of queue poll Error explanation
-200	<b>Execution error</b> Error on execution of the command.
-201	<b>Invalid while in local</b> The command is not executable while the device is in local due to a hard local control. Example: The device receives a command which would change the rotary knob state, but the device is in local so the command can not be executed.
-202	<b>Settings lost due to rtl</b> A setting associated with hard local control was lost when the device changed to LOCS from REMS or to LWLS from RWLS.
-210	<b>Trigger error</b> Error on triggering the device.
-211	<b>Trigger ignored</b> The trigger (GET, *TRG or trigger signal) was ignored because of device timing considerations. Example: The device was not ready to respond.
-212	<b>Arm ignored</b> An arming signal was ignored by the device.
-213	<b>Init ignored</b> Measurement initialisation was ignored as another measurement was already in progress.
-214	<b>Trigger deadlock</b> The trigger source for the initiation of measurement is set to GET and subsequent measurement is received. The measurement cannot be started until a GET is received, but the GET would cause an interrupted-error)
-215	<b>Arm deadlock</b> The trigger source for the initiation of measurement is set to GET and subsequent measurement is received. The measurement cannot be started until a GET is received, but the GET would cause an interrupted-error.
-220	<b>Parameter error</b> The command contains a faulty or invalid parameter.
-221	<b>Settings conflict</b> There is a conflict between setting of parameter value and instrument state.
-222	<b>Data out of range</b> The parameter value lies out of the allowed range of the instrument.
-223	<b>Too much data</b> The command contains too many data. Example: The instrument does not have sufficient storage space.
-224	<b>Illegal parameter value</b> The parameter value is invalid. Example: The text parameter is invalid , TRIGger : SWEep : SOURce TASTe

Continuation: Execution Error

Error code	Error text in the case of queue poll Error explanation
-230	<b>Data corrupt or stale</b> The data are incomplete or invalid. Example: The instrument has aborted a measurement.
-231	<b>Data questionable</b> The measurement accuracy is suspect.
-240	<b>Hardware error</b> The command cannot be executed due to problems with the instrument hardware.
-241	<b>Hardware missing</b> Hardware is missing. Example: An option is not fitted.
-250	<b>Mass storage error</b> A mass storage error occurred.
-251	<b>Missing mass storage</b> The mass storage is missing. Example: An option is not installed.
-252	<b>Missing media</b> The media is missing. Example: There is no floppy in the floppy disk drive.
-253	<b>Corrupt media</b> The media is corrupt. Example: The floppy is bad or has the wrong format.
-254	<b>Media full</b> The media is full. Example: There is no room on the floppy.
-255	<b>Directory full</b> The media directory is full.
-256	<b>File name not found</b> The file name cannot be found on the media.
-257	<b>File name error</b> The file name is wrong. Example: An attempt is made to copy to a duplicate file name.
-258	<b>Media protected</b> The media is protected. Example: The write-protect tab on the floppy is present.
-260	<b>Expression error</b> The expression contains an error.

Device Specific Error; sets bit 3 in the ESR register

Error code	Error test in the case of queue poll Error explanation
-300	<b>Device-specific error</b> ESPI-specific error not defined in greater detail.
-310	<b>System error</b> This error message suggests an error within the instrument. Please inform the R&S Service.
-313	<b>Calibration memory lost</b> Loss of the non-volatile data stored using the *CAL? command. This error occurs when the correction data recording has failed.
-330	<b>Self-test failed</b> The selftest could not be executed.
-350	<b>Queue overflow</b> This error code is entered in the queue instead of the actual error code if the queue is full. It indicates that an error has occurred but not been accepted. The queue can accept 5 entries.

Query Error - Error in data request; sets bit 2 in the ESR register

Error code	Error text in the case of queue poll Error explanation
-400	<b>Query error</b> General error occurring when data are requested by a query.
-410	<b>Query INTERRUPTED</b> The query has been interrupted. Example: After a query, the instrument receives new data before the response has been sent completely.
-420	<b>Query UNTERMINATED</b> The query is incomplete. Example: The instrument is addressed as a talker and receives incomplete data.
-430	<b>Query DEADLOCKED</b> The query cannot be processed. Example: The input and output buffers are full, the instrument cannot continue operation.
-440	<b>Query UNTERMINATED after indefinite response</b> A query is in the same command line after a query which requests an indefinite response.



## Device-Specific Messages

Error code	Error text in the case of queue poll Error explanation
1036	<b>MS: The correction table based amplifier gain exceeds the amplifier range for CALAMP1 and CALAMP2 on IF board</b> This message is output when the setting range of the calibration amplifier is not sufficient for the required correction. The error occurs only with modules which are not correctly adjusted or defective.
1052	<b>Frontend LO is Unlocked</b> This message is output when the phase regulation of the local oscillator fails in the RF frontend.
1060	<b>Trigger-Block Gate Delay Error- gate length &lt; Gate Delay</b> This message is output when the gate signal length is not sufficient for the pull-in delay with a predefined gate delay.
1064	<b>Tracking LO is Unlocked</b> This message is output when the phase regulation of the local oscillator fails on the tracking generator module.

Error code	Error text in the case of queue poll Error explanation
2022	<b>OPTIONS.INI invalid</b> This message is output when an error has been recognized in the file OPTIONS.INI which contains the clearing codes for retrofitable firmware applications. If this file is not correctly recognized, all firmware applications are blocked for this instrument.
2028	<b>Hardcopy not possible during measurement sequence</b> This message is output when a printout is started during scan sequences that cannot be interrupted. Such sequences are for example: <ul style="list-style-type: none"> <li>• Recording the system error correction data (calibration)</li> <li>• Instrument selftest</li> </ul> In such cases a synchronization to the end of the scan sequence should be performed prior to starting the printout.
2033	<b>Printer Not Available</b> This message is output when the selected printer is not included in the list of available output devices. A possible cause is that the required printer driver is missing or incorrectly installed.
2034	<b>CPU Temperature is too high</b> This message is output when the temperature of the processor exceeds 70 °C.

## 10 Index

**Note:** All softkeys are listed alphabetically under keyword "Softkey" with their names. The page numbers 4.xxx refer to the detailed description of the softkeys in chapter 4. Generally, the number of the page in chapter 6 containing the equivalent remote control command is given in addition.

A list of softkeys and equivalent remote control commands or command sequences is given in chapter 6, section "Table of Softkeys with IEC/IEEE-Bus Command Assignment".

Chapter 6 also contains an alphabetical list of all remote control commands.

\*

\* (enhancement lable)..... 3.6, 4.95

### 0 ... 7

0 to 9 (key) ..... 3.11  
 1 - 3 (trace info) ..... 4.105  
 10 dB setting ..... 4.9  
 20.4 MHz Out ..... 8.12  
 3 dB bandwidths ..... 4.11  
 6 dB bandwidths ..... 4.11  
 75  $\Omega$  (enhancement lable) ..... 3.6

### A

Abort  
   print ..... 4.229  
   recording of correction data ..... 4.106  
 AC supply connection ..... 1.14  
 ACP measurement ..... 4.137  
 Addressed command ..... 8.5  
 Adjacent-channel power measurement ..... 4.139  
 Administrator function ..... 1.17  
 AF demodulation ..... 4.121  
 AF OUTPUT ..... 8.2  
 AM demodulation ..... 4.20, 4.122  
 AM modulation ..... 4.248  
 AM modulation depth ..... 4.163  
 Amplitude ..... 4.67  
 Amplitude probability distribution function ..... 4.157  
 Amplitude statistics ..... 4.155  
 Analyzer mode ..... 4.61  
 Annotation ..... 4.182  
 AP (trace info) ..... 3.5  
 APD function ..... 4.157  
 Ascii # ..... 5.12  
 ASCII file export  
   final measurement data ..... 4.25  
   scan data ..... 4.58  
 Attenuation ..... 4.8, 4.69  
 Autopeak detector ..... 4.102  
 AV (trace info) ..... 3.5  
 Average detector ..... 4.16, 4.17, 4.101, 4.104  
 Averaging ..... 4.94, 4.135  
   continuous sweep ..... 4.94  
   lin/log ..... 4.96  
   single sweep ..... 4.94  
   sweep count ..... 4.94  
 AVG (trace info) ..... 3.5  
 Axis  
   adjustment ..... 4.43

### B

BACK (key) ..... 3.11  
 Band filter, digital ..... 4.13, 4.76  
 Bandpass ..... 4.76  
 Bandwidth  
   occupied ..... 4.152  
   resolution ..... 4.72  
   video ..... 4.73  
 Baud rate ..... 4.204  
 Block data ..... 5.12  
 Boolean parameter ..... 5.11  
 Brightness ..... 4.184, 4.233

### C

Cables EZ-xx ..... 4.35  
 Calibration  
   functioning ..... 4.245, 4.259  
   reflection measurement ..... 4.258  
   reflexion measurement ..... 4.244  
   transmission measurement ..... 4.238, 4.252  
 Calibration results ..... 4.107  
 CANCEL (key) ..... 3.11  
 CCDF function ..... 4.157  
 CCIR 473-4 ..... 4.91  
 CCVS signal ..... 4.91  
 Center frequency ..... 4.62  
   step size ..... 4.62  
 Channel  
   power ..... 4.146  
   bandwidth ..... 4.145, 4.153  
   number ..... 4.144  
   spacing ..... 4.146  
 Channel filters ..... 4.14, 4.78  
 Channel power measurement ..... 4.139  
 Characters, special ..... 6.2  
 Clear/Write mode ..... 4.55, 4.93  
 CLWR (trace info) ..... 3.5  
 Colon ..... 5.12  
 Color ..... 4.185, 4.234  
 Colors  
   hardcopy ..... 4.232  
 COM interface ..... 4.204, 8.7  
 Comma ..... 4.25, 5.12  
 Command  
   # ..... 5.12  
   addressed ..... 8.5  
   alphabetical list ..... 6.206  
   colon ..... 5.12  
   comma ..... 5.12  
   description ..... 6.1  
   header ..... 5.8  
   line ..... 5.10  
   list ..... 6.206

- long form ..... 5.9
  - overlapping execution ..... 5.15
  - programming examples ..... 7.1
  - query ..... 5.10
  - question mark ..... 5.10, 5.12
  - quotation mark ..... 5.12
  - recognition ..... 5.14
  - sequence ..... 5.15
  - short form ..... 5.9
  - softkey assignment ..... 6.217
  - structure ..... 5.7
  - suffix ..... 5.9
  - syntax elements ..... 5.12
  - universal ..... 8.5
  - white space ..... 5.12
  - Common commands ..... 6.4
  - CONDition register part ..... 5.17
  - Configuration ..... 4.186
    - save ..... 4.218
  - Connection cables ..... 4.35
  - Continue single sweep ..... 4.81
  - Continuous sweep ..... 4.80
  - Control
    - output level ..... 4.237
  - Control characters ..... 8.9
  - Copy
    - file ..... 4.226
    - limit line ..... 4.171
    - trace ..... 4.60, 4.99
  - Correction data ..... 4.106
  - Correction of entry ..... 3.17
  - Correction values
    - normalization ..... 4.235, 4.250
  - Counter resolution ..... 4.111
  - Coupling
    - bandwidths ..... 4.71
    - default settings ..... 4.74, 4.76
    - frequency of diagrams ..... 4.181
    - IF bandwidth to frequency range ..... 4.13, 4.17
    - reference level of diagrams ..... 4.181
    - resolution bandwidth ..... 4.73
    - sweep time ..... 4.74
    - video bandwidth ..... 4.74
  - CP measurement ..... 4.139
  - Culmulative distribution function ..... 4.157
- D**
- Data reduction ..... 4.21
  - Date ..... 4.182
    - input ..... 4.207
  - DCL ..... 5.14
  - Decimal point ..... 3.11
  - Decimal separator ..... 4.25
  - Default
    - coupling ratios ..... 4.74
    - display settings ..... 4.183
    - print colors ..... 4.234
    - scalings of x- and y-axis ..... 4.159
    - scan table ..... 4.38
  - Delay, gate signal ..... 4.88
  - Delete
    - file ..... 4.226
    - limit line ..... 4.171
    - line of peak list ..... 4.24
    - line of transducer table ..... 4.197
    - scan range ..... 4.43
    - transducer factor/set ..... 4.193
  - Demodulation ..... 4.20, 4.121
  - Detector
    - autopeak ..... 4.100
    - average ..... 4.16, 4.17, 4.101
    - max peak ..... 4.16, 4.17, 4.100
    - min peak ..... 4.16, 4.17, 4.100
    - quasi-peak ..... 4.16, 4.17, 4.54, 4.56, 4.101
    - RMS ..... 4.16, 4.17, 4.101
    - sample ..... 4.100
  - Device reset (overall) ..... 4.2
  - Directory
    - create ..... 4.226
    - rename ..... 4.226
  - Diskette, format ..... 4.226
    - brightness ..... 4.184, 4.233
    - color ..... 4.185, 4.234
    - date ..... 4.182
    - deactivation during single sweep ..... 4.82
    - saturation ..... 4.185, 4.234
    - time ..... 4.182
    - tint ..... 4.184, 4.233
    - title ..... 4.182
  - Display mode
    - full screen ..... 3.8, 4.180
    - split screen ..... 3.8, 4.181
  - Display range
    - frequency ..... 4.62
    - level ..... 4.8, 4.67
    - span ..... 4.66
  - Distribution function ..... 4.157
  - Double dagger ..... 5.12
- E**
- Editing
    - limit line ..... 4.172
    - parameter ..... 3.16
    - table ..... 3.21
  - Electrostatic discharge ..... 1.12
  - EMI Protection ..... 1.14
  - ENABle register part ..... 5.17
  - Enabling the front panel keys ..... 4.4
  - Enhancement labels ..... 3.6
  - ENTER (key) ..... 3.11
  - Entry
    - abort ..... 3.11
    - activate ..... 3.14, 3.23
    - correct ..... 3.17
    - terminate ..... 3.11
  - ENV 4200 ..... 4.33
  - Error messages ..... 4.213, 9.1
  - Error variable - iberr ..... 4.289
  - Error-queue query ..... 5.31
  - ESC (key) ..... 3.11
  - ESE (event status enable register) ..... 5.20
  - ESH2-Z5 ..... 4.33
  - ESH3-Z5 ..... 4.33
  - ESR (event status register) ..... 5.20
  - EVENT register part ..... 5.17
  - Event status enable register (ESE) ..... 5.20
  - Event status register (ESR) ..... 5.20
  - EXT (enhancement lable) ..... 3.6
  - EXT TRIGGER/GATE input ..... 4.46, 4.84, 8.11
  - External generator ..... 4.250
  - External noise source ..... 4.187
  - EZ-14 ..... 4.35
  - EZ-21 ..... 4.35
  - EZ-5 ..... 4.35
  - EZ-6 ..... 4.35

**F**

Fast power measurement .....	4.147
FFT filter .....	4.13, 4.76
Field, first or second .....	4.91
File	
copy .....	4.226
delete .....	4.226
rename .....	4.226
sort .....	4.226
Filter	
band filter .....	4.13, 4.76
FFT .....	4.13, 4.76
Final measurement	
automatic routine .....	4.28
continuation .....	4.30
detector .....	4.32
halt .....	4.30
interactive routine .....	4.29
interruption .....	4.30
measurement time .....	4.28
start .....	4.29
Final phases .....	4.34
Firmware update .....	4.217
Firmware version .....	4.212
Fixed filter .....	4.76
FM demodulation .....	4.20, 4.122
FM modulation .....	4.248
Free-run sweep .....	4.46, 4.83
Frequency .....	4.61
axis labelling .....	3.4
center .....	4.62
counter .....	4.111
coupling of diagrams .....	4.181
display window .....	4.61, 4.66
line .....	4.177
offset .....	4.65
Offset (ext. generator) .....	4.260
offset (tracking generator) .....	4.246
receiver .....	4.6
scan .....	4.40
span .....	4.66
start .....	4.64
stop .....	4.64
switching off display .....	4.182
Frequency-converting measurements .....	4.246, 4.260
FRQ (enhancement table) .....	3.6
Full screen .....	3.8, 4.180
Full span .....	4.66

**G**

GAT (enhancement table) .....	3.6
Gate	
delay .....	4.88
external/internal .....	4.86
length .....	4.88
GET (Group Execute Trigger) .....	5.14
GHz-dBm (key) .....	3.11

**H**

Hardcopy	
format .....	4.230
orientation .....	4.230
screen .....	4.228
Hardware adjustment .....	4.217
Hardware settings, indication .....	3.4

Header .....	5.8
Help line editor .....	3.20
Hold scan .....	4.45
Horizontal sync signal .....	4.91
Hotkey	
NETWORK .....	4.235, 6.165
RECEIVER .....	4.3, 4.5, 6.107
SCREEN A/B .....	4.3, 6.90
SPECTRUM .....	4.3, 4.61, 6.107
Hz/dB. (key) .....	3.11

**I**

I/Q modulation .....	4.249
IEC/IEEE bus	
address .....	4.202
command description .....	6.1
interface .....	8.3
interface functions .....	8.4
programming examples .....	7.1
IF bandwidth .....	4.11
coupling to frequency range .....	4.13, 4.17
IFOVL .....	3.5
I-ModellUser port	
configuration .....	4.203
Impedance of input .....	4.70
Indication	
hardware settings .....	3.4
instrument settings .....	3.6
marker information .....	3.4
Initial configuration .....	4.2
Input	
EXT TRIGGER/GATE .....	4.46, 4.84, 8.11
REF IN .....	8.12
Input impedance .....	4.70
Instrument functions .....	4.1
Interface functions	
IEC/IEEE bus .....	8.4
Interfaces .....	8.2
Intermodulation product .....	4.164
Interrupt .....	5.30
Interrupt scan .....	4.45
IST flag .....	5.20

**K**

Key	
0 to 9 .....	3.11
AMPT .....	4.8, 4.67
BACK .....	3.11
BW .....	4.11, 4.72
CAL .....	4.106
CANCEL .....	3.11
DISP .....	4.179
ENTER .....	3.11
ESC .....	3.11, 6.18
FILE .....	4.218
FREQ .....	4.61
GHz-dBm .....	3.11
Hz/dB .....	3.11
kHz/dB .....	3.11
LINES .....	4.168
MEAS .....	4.131
MHz/dBm .....	3.11
MKR .....	4.47, 4.108
MKR FCTN .....	4.53, 4.115
MKR to .....	4.48, 4.123
PRESET .....	4.2, 6.6, 6.189

- roll-key..... 3.12
  - SETUP..... 4.186
  - SPAN..... 4.66
  - SWEEP..... 4.39, 4.80
  - TRACE..... 4.54, 4.92
  - TRIG..... 4.46, 4.83
  - Keyboard
    - connection..... 1.18
    - connector..... 8.2
  - kHz/dB (key)..... 3.11
- L**
- LAN-Interface..... 4.266
  - Level..... 4.67
    - axis unit..... 4.10
    - display range..... 4.67
    - line..... 4.178
    - offset (phase noise)..... 4.119
    - offset (tracking generator)..... 4.237
    - range..... 4.67
    - reference..... 4.67
  - Level display..... 4.8
  - Limit
    - ACP measurement..... 4.148
    - evaluation range..... 4.134
    - probability range..... 4.159
  - Limit check..... 4.170
    - ACP measurement..... 4.148
  - Limit Check..... 4.170
  - Limit line
    - copy..... 4.171
    - delete..... 4.171
    - domain..... 4.173
    - edit..... 4.172
    - limit check..... 4.170
    - offset..... 4.171
    - save..... 4.176
    - scaling..... 4.174
    - select..... 4.169
    - shift..... 4.176
    - unit..... 4.174
    - value..... 4.176
  - Line
    - display 1,2..... 4.178
    - frequency 1, 2..... 4.178
    - limit..... 4.169
    - reference (tracking generator)..... 4.241, 4.255
    - threshold..... 4.50, 4.126
    - time 1, 2..... 4.178
  - Line Impedance Stabilization Networks..... 4.33
  - Line system..... 4.91
  - Lines..... 4.178
  - LISN..... 4.33
  - LO exclude..... 4.130
  - Login/out (NT controller)..... 1.17
  - Logo..... 4.182
  - Lower case..... 6.2
  - LPT interface..... 8.6
  - center frequency to..... 4.124
  - CF stepsize to..... 4.51, 4.129
  - indication..... 3.4
  - N dB Down..... 4.120
  - normal..... 4.108
  - peak..... 4.49, 4.116, 4.123
  - reference level to..... 4.124
  - search limit..... 4.50, 4.126
  - signal track..... 4.65
    - to trace..... 4.47, 4.110, 4.122
    - zoom..... 4.114
  - Max hold..... 4.55, 4.93
  - Max peak detector..... 4.16, 4.17, 4.103
  - MAXH (trace info)..... 3.5
  - Maximum peak value..... 4.135
  - Maximum search..... 4.49, 4.123
  - Maximum value..... 4.133
  - Mean power (GSM burst)..... 4.134
  - Mean value..... 4.134
  - Measurement
    - examples..... 2.1
    - frequency-converting..... 4.246, 4.260
    - reflection..... 4.258
    - reflexion..... 4.244
    - time..... 4.18
    - transmission..... 4.238, 4.252
  - Measurement converters..... 4.190
  - Measurement example
    - ACP with user-specific channel configuration..... 4.150
    - adjacent-channel power for a specific standard..... 4.149
    - CCDF of a IS95 BTS signal..... 4.160
    - occupied bandwidth of a PDC signal..... 4.154
    - signal/noise power density (C/No) of an IS95 CDMA signal..... 4.151
  - Measurement, save..... 4.218
  - Memory, battery-powered..... 1.16
  - Menu
    - call..... 3.10
    - change keys..... 3.10
  - Messages..... 4.213
    - acknowledgement..... 3.7
  - MHz/dBm (key)..... 3.11
  - MI (trace info)..... 3.5
  - Min hold..... 4.58, 4.96
  - Min peak detector..... 4.16, 4.17, 4.103
  - MINH (trace info)..... 3.5
  - Minimum search..... 4.51, 4.130
  - Mobile radio standard..... 4.140
  - Mode
    - analyzer..... 4.61
    - receiver..... 4.5
  - Modulation
    - external (tracking generator)..... 4.247
  - Modulation depth..... 4.163
  - Monitor
    - connection..... 1.20
    - connector..... 8.11
  - Mouse
    - connection..... 1.19
    - connector..... 8.11
  - Mouse-Buchse..... 8.2
  - MSG..... 3.5
- M**
- Maintenance..... 8.1
  - Manual operation
    - return to..... 5.3
    - switch to..... 4.4
  - Margin..... 4.28
  - Marker..... 4.108
- N**
- Network..... 4.235
  - Noise
    - source, external..... 4.187
  - Noise measurement..... 4.116
  - NOISE SOURCE..... 8.11

Normalization.....4.240, 4.254  
 NT computer..... 1.17  
 NTRansition register part..... 5.17  
 Numerical values (command) ..... 5.11

**O**

Occupied bandwidth..... 4.152  
 Offset  
   frequency ..... 4.65  
   frequency (ext. generator) ..... 4.260  
   gate signal..... 4.88  
   level (tracking generator)..... 4.237  
   limit line ..... 4.171  
   phase noise..... 4.119  
   reference level..... 4.69  
   trigger..... 4.84  
 Operating mode  
   analyzer..... 4.61  
   receiver ..... 4.5  
 Operating time ..... 4.212  
 Option  
   ESPI-B2 - PRESELECTOR..... 4.9  
   FSP-B6 - TV- and RF-Trigger..... 4.90  
   FSP-B9 – Tracking Generator ..... 4.235  
   FSP-B10 – External Generator..... 4.250  
   FSP-B16 – LAN Interface ..... 4.266  
 Order number ..... 4.211  
 Orientation..... 4.230  
 Output  
   AF OUTPUT..... 8.2  
   IF 20.4 MHz Out ..... 8.12  
   noise source control ..... 8.11  
   REF OUT ..... 8.12  
 Output level  
   control ..... 4.237  
 OVEN..... 3.5  
 Overwrite mode ..... 4.55, 4.93  
 OVLD..... 3.5, 4.245, 4.259

**P**

Packing..... 8.1  
 Parallel poll..... 5.31  
 Parallel poll enable register (PPE) ..... 5.20  
 Parameter  
   block data..... 5.12  
   boolean ..... 5.11  
   editing..... 3.16  
   numerical values ..... 5.11  
   selection ..... 3.13  
   string ..... 5.12  
   text ..... 5.12  
 Password  
   service functions..... 4.215  
   Windows NT..... 1.17  
 Path..... 4.225  
 Peak  
   detector ..... 4.16, 4.56  
 Peak excursion..... 4.51, 4.127  
 Peak list..... 4.22  
 PEAK LIST ON / OFF..... 4.57  
 Peak search ..... 4.49, 4.116, 4.123  
 PHASE N..... 4.34  
 Phase noise measurement ..... 4.118  
 Phase setting..... 4.34  
 PK (trace info)..... 3.5

Polarity  
   external trigger/gate ..... 4.87  
   trigger edge..... 4.46, 4.84  
   video ..... 4.91  
 Power bandwidth percentage ..... 4.152  
 Power cables ..... 8.1  
 Power measurement ..... 4.131  
   CP/ACP ..... 4.137  
   Fast..... 4.147  
   occupied bandwidth ..... 4.152  
   signal amplitude statistics ..... 4.155  
   signal/noise ..... 4.161  
   Time Domain..... 4.132  
 Power, mean ..... 4.134  
 PPE (parallel poll enable register) ..... 5.20  
 Preamplification..... 4.9, 4.188, 4.189  
 Preparing the instrument for Operation..... 1.12  
 PRESCAN PHASES ..... 4.34  
 Preselection ..... 4.188  
 Preset instrument ..... 4.2  
 Pretrigger ..... 4.84  
 Print  
   abort ..... 4.229  
   start..... 4.228  
 PRINT SCREEN (gate signal) ..... 4.88  
 Printer  
   configuration ..... 4.227  
   connection ..... 1.21, 8.6  
   interface ..... 8.6  
 PRN (enhancement lable) ..... 3.6  
 Probe Power connector..... 8.2  
 Protective earth conductor ..... 4.34  
 Protective earth setting..... 4.34  
 PTRansition register part..... 5.17  
 Putting into operation  
   AC supply connection ..... 1.14  
 Getting Started with the instrument ..... 1.12

**Q**

QP (trace info)..... 3.5  
 Quasi-peak detector..... 4.16, 4.17, 4.54, 4.56, 4.101  
 Query ..... 5.10, 5.31  
 Question mark..... 5.10, 5.12  
 Quotation mark..... 5.12

**R**

Rackmounting ..... 1.13  
 Receiver..... 4.5  
   frequency ..... 4.6  
   frequency stepsize ..... 4.7  
   level ..... 4.8  
 Recording the correction data ..... 4.106  
 Reference  
   dataset (tracking generator) ..... 4.245, 4.259  
   external ..... 4.187  
   fixed ..... 4.112  
   frequency ..... 4.112  
   level to marker level ..... 4.124  
   line (tracking generator) ..... 4.241, 4.255  
   position for normalization ..... 4.255  
 Reference level ..... 4.67  
   channel power..... 4.141  
   coupling of diagrams ..... 4.181  
   offset..... 4.69  
   position ..... 4.69  
   to marker level ..... 4.124

- Reference point
    - frequency ..... 4.112
    - frequency (phase noise) ..... 4.120
    - level ..... 4.112
      - offset ..... 4.112
    - level (phase noise) ..... 4.119
      - offset ..... 4.119
    - time ..... 4.113
  - Reference value
    - channel power ..... 4.141
    - time domain power ..... 4.135
  - Reflection measurement ..... 4.244, 4.258
  - Remote control
    - basics ..... 5.1
    - IEC/IEEE bus ..... 5.3
    - local network (RSIB) ..... 5.5, 4.286
    - RS-232-C ..... 5.4
    - switch over ..... 5.2
  - Rename
    - directory ..... 4.226
    - file ..... 4.226
  - Reset
    - device ..... 4.2
    - status reporting system ..... 5.32
  - Resolution bandwidth ..... 4.12, 4.72
  - Resolution counter ..... 4.111
  - RF attenuation ..... 4.8, 4.69
  - RFI reception ..... 4.5
  - RM (trace info) ..... 3.5
  - RMS detector ..... 4.16, 4.17, 4.101, 4.103
  - RMS value ..... 4.133
  - Roll-key ..... 3.12
  - RS-232-C
    - configuration ..... 4.204
    - interface ..... 8.7
    - transmission parameters ..... 8.8
- S**
- SA (trace info) ..... 3.5
  - Sample detector ..... 4.103
  - Sample number ..... 4.158
  - Saturation ..... 4.185, 4.234
  - Save
    - configuration ..... 4.218
    - limit line ..... 4.176
    - measurement ..... 4.218
  - Scalar reflection measurement ..... 4.244, 4.258
  - Scaling
    - level axis ..... 4.70
    - level display range ..... 4.68
    - limit line ..... 4.174
    - x- and y-axis (signal statistic) ..... 4.158
  - Scan ..... 4.37
    - default setup ..... 4.38
    - entry ..... 4.39
    - hold ..... 4.45
    - run ..... 4.45
    - stop ..... 4.45
  - SCPI
    - conformity information ..... 6.1
    - introduction ..... 5.7
    - version ..... 5.1
  - Screen ..... 3.1
    - full screen ..... 4.180
    - split screen ..... 3.8, 4.181
    - subdivision ..... 3.2
  - Search
    - bandwidth ..... 4.65
    - direction ..... 4.52, 4.125
    - minimum ..... 4.51, 4.130
    - peak ..... 4.49, 4.116, 4.123
    - peak excursion ..... 4.51, 4.127
    - range ..... 4.50, 4.126
  - Search method for peak list ..... 4.28
  - Selftest ..... 4.216
  - Sensitivity
    - APD measurement ..... 4.159
    - CCDF measurement ..... 4.159
  - Serial interface ..... 8.7
    - configuration ..... 4.204
  - Serial number ..... 4.211
  - Serial poll ..... 5.30
  - Service functions ..... 4.214
  - Service request (SRQ) ..... 5.19, 5.30
  - Service request enable register (SRE) ..... 5.19
  - Setting up the Instrument ..... 1.12
  - Settings, indication ..... 3.6
  - Setup ..... 4.186
    - general ..... 4.202
  - SGL (enhancement table) ..... 3.6
  - Sign (key) ..... 3.11
  - Signal amplitude statistics ..... 4.155
  - Signal count ..... 4.111
  - Signal tracking ..... 4.65
    - search bandwidth ..... 4.65
  - Single sweep ..... 4.80
  - Softkey
    - % POWER BANDWIDTH ..... 4.152, 6.151
    - = CENTER ..... 4.63, 4.64
    - = MARKER ..... 4.63, 4.64
    - 0.1 \* RBW ..... 4.63, 6.135, 6.136
    - 0.1 \* SPAN ..... 4.62, 6.135, 6.136
    - 0.5 \* RBW ..... 4.63, 6.135, 6.136
    - 0.5 \* SPAN ..... 4.62, 6.135, 6.136
    - 1 MHz ..... 4.12, 6.124
    - 10 DB MIN ON/OFF ..... 4.9, 6.104
    - 120 kHz ..... 4.12, 6.124
    - 200 Hz ..... 4.12, 6.124
    - 9 kHz ..... 4.12, 6.124
    - ABSOLUTE PEAK/MIN ..... 4.52, 4.125, 6.11, 6.12
    - ACP LIMIT CHECK ..... 4.148, 6.20
    - ADD TO PEAK LIST ..... 4.49
    - ADJ CHAN BANDWIDTH ..... 4.145, 6.150
    - ADJ CHAN SPACING ..... 4.146, 6.148, 6.149
    - ADJUST AXIS ..... 4.43
    - ADJUST REF LVL ..... 4.141, 4.153, 6.151
    - ADJUST SETTINGS ..... 4.159, 4.162, 6.77, 6.151
    - ADJUST SETTINGS (occupied bandwidth) ..... 4.153
    - ADJUST SETTINGS (power measurements) ..... 4.142
    - ALL MARKER OFF ..... 4.114, 6.9, 6.40
    - AM ..... 4.20, 4.122, 6.49, 6.132
    - AMPERE ..... 4.68, 6.82
    - ANNOTATION ON/OFF ..... 4.182, 6.88
    - APD ON/OFF ..... 4.157, 6.76, 6.79
    - area ..... 3.9
    - ASCII FILE EXPORT ..... 4.25, 4.58, 4.97, 6.95, 6.116
    - AUTO COARSE ..... 4.7
    - AUTO FINE ..... 4.7
    - AUTO RANGE ON/OFF ..... 4.9, 6.104
    - AUTO SELECT ..... 4.102, 6.133
    - AUTOMATIC FINAL ..... 4.28, 4.30
    - AUTOPREAMP ON/OFF ..... 4.10, 6.106
    - AVERAGE ..... 4.17, 4.56, 4.94, 6.93, 6.123, 6.134
    - AVERAGE ON/OFF ..... 4.135, 6.63, 6.64, 6.66, 6.68, 6.70
    - AVG MODE LOG/LIN ..... 4.96, 6.74, 6.123
    - BLANK ..... 4.55, 4.95, 6.93
    - BRIGHTNESS ..... 4.184, 4.233, 6.89, 6.97
    - C/N ..... 4.162, 6.54
    - C/N, C/N0 ..... 4.161
    - C/No ..... 4.162, 6.54
    - CAL ABORT ..... 4.106, 6.83

CAL CORR ON/OFF	4.107, 6.84	DETECTOR SAMPLE	4.103, 6.133
CAL GEN 128 MHZ	4.215, 6.85	DEVICE 1/2	4.229, 6.98, 6.99, 6.100, 6.115, 6.186
CAL REFL OPEN	4.244, 4.258, 6.128	DISPLAY LINE 1/2	4.178, 6.74
CAL REFL SHORT	4.244, 4.258, 6.128	DISPLAY PWR SAVE	4.183, 6.88
CAL RESULTS	4.107, 6.84	EDIT	4.193, 4.194, 4.198, 6.129, 6.130, 6.131
CAL TOTAL	4.106, 6.83	EDIT ACP LIMITS	4.148, 6.20, 6.21, 6.22, 6.23, 6.24, 6.25, 6.26, 6.27, 6.28, 6.29
CAL TRANS	4.239, 4.253, 6.128	EDIT COMMENT	4.221, 6.120
CCDF ON/OFF	4.157, 6.76, 6.79	EDIT FREQUENCY	4.24
CCVS INT / EXT	4.91, 6.161	EDIT LIMIT LINE	4.173, 6.17, 6.31, 6.34, 6.36, 6.37, 6.38
CENTER	4.62, 6.135	EDIT PATH	4.225, 6.110, 6.115
CENTER = MKR FREQ	4.124, 6.52	EDIT PEAK LIST	4.23
CENTER A = MARKER B	4.181, 6.107	ENABLE ALL ITEMS	4.223, 6.120
CENTER B = MARKER A	4.181, 6.107	ENTER PASSWORD	4.215, 6.189
CHAN PWR /ACP	4.139, 6.54	ESH2-Z5/ENV 4200	4.33, 6.104
CHAN PWR /HZ	4.141, 6.57	ESH3-Z5	4.33, 6.104
CHANNEL BANDWIDTH	4.145, 4.153, 4.162, 6.149	EXCLUDE LO	4.130, 6.43
CLEAR ALL MESSAGES	4.213, 6.187, 6.188	EXT AM	4.248, 6.162
CLEAR/WRITE	4.55, 4.93, 6.93	EXT FM	4.248, 6.163
CNT RESOL	4.111, 6.42	EXT I/Q	4.249, 6.162
COLOR ON/ OFF	4.232, 6.99	EXT SOURCE	4.261
COLORS	4.231, 4.232	EXT SRC ON/OFF	4.261, 6.165
COM INTERFACE	4.204, 6.184	EXTERN	4.46, 4.84, 6.160, 6.202
command assignment	6.217	FAST ACP ON/OFF	4.147, 6.152
COMMENT SCREEN A/B	4.231, 6.100	FILE MANAGER	4.225, 6.110
CONFIG DISPLAY	4.182, 6.88	FILTER TYPE	4.76, 6.125
CONFIGURE NETWORK	4.208	FINAL AVERAGE	4.57, 6.134
CONT AT HOLD	4.45	FINAL MAX PEAK	4.56, 6.134
CONT AT REC FREQ	4.45, 6.101	FINAL MEAS TIME	4.28, 6.158
CONT DEMOD	4.122, 6.50	FINAL MIN PEAK	4.57, 6.134
CONT MEAS	4.160, 6.101, 6.102	FINAL PHASES	4.34
CONTINUE SGL SWEEP	4.81, 6.101, 6.102	FINAL QUASIPEAK	4.57, 6.134
CONTINUOUS SCAN	4.44, 6.101	FINAL RMS	4.57, 6.134
CONTINUOUS SWEEP	4.80, 6.101, 6.102	FIRMWARE UPDATE	4.217
COPY	4.226, 6.110	FM	4.20, 4.122, 6.49, 6.132
COPY LIMIT LINE	4.171, 6.18	FORMAT DISK	4.226, 6.112
COPY TRACE	4.60, 4.99, 6.193	FREE RUN	4.46, 4.83, 6.202
COUPLING DEFAULT	4.76, 6.125, 6.157	FREQ AXIS LIN/LOG	4.44, 6.91
COUPLING RATIO	4.74, 6.125	FREQUENCY LINE 1/2	4.178, 6.74
CP/ACP ABS/REL	4.146, 6.150	FREQUENCY OFFSET	4.65, 4.246, 4.260, 6.137, 6.163
CP/ACP CONFIG	4.144, 6.20, 6.148	FREQUENCY SWEEP	4.264, 6.166, 6.167
CP/ACP ON/OFF	4.139, 6.54, 6.55, 6.58	FULL SCREEN	4.180, 6.88
CP/ACP STANDARD	4.140, 6.58	FULL SPAN	4.66, 6.136
DATA SET CLEAR	4.224, 6.117	GATE DELAY	4.88, 6.159
DATA SET CLEAR ALL	4.224, 6.117	GATE LENGTH	4.88, 6.159
DATA SET LIST	4.223	GATE MODE LEVEL/EDGE	4.87, 6.159
DATAENTRY OPAQUE	4.183	GATE SETTINGS	4.87, 6.158
dBm	4.10, 4.68, 6.82	GATED TRIGGER	4.86, 6.158, 6.160
dBmV	4.68, 6.82	GENERAL SETUP	4.202
dBpT	4.10, 6.82	GPIB ADDRESS	4.202, 6.181
dBpW	4.68, 6.82	GRID ABS/REL	4.70, 6.91
dB $\mu$ A	4.10, 4.68, 6.82	GRID MIN LEVEL	4.10, 6.93
dB $\mu$ V	4.10, 4.68, 6.82	GRID RANGE LOG 100 dB	4.10, 6.91
DECIM SEP	4.25, 4.60, 4.99, 6.95	GRID RANGE LOG MANUAL	4.10, 6.91
DEFAULT COLORS	4.183, 6.89, 6.96	HARDCOPY ABORT	4.229, 6.96
DEFAULT CONFIG	4.223, 6.120	HARDWARE INFO	4.211, 6.5
DEFAULT SETTINGS	4.159, 6.78	HOLD FINAL MEAS	4.30
DELETE	4.226, 6.112, 6.116	HOLD SCAN	4.45, 6.7
DELETE (peak list)	4.24	HOR SYNC	4.91, 6.204
DELETE FACTOR/SET	4.193, 6.130, 6.131	IF POWER	4.84, 6.160, 6.202, 6.203
DELETE LIMIT LINE	4.171, 6.19	INPUT CAL	4.214, 4.215, 6.85, 6.86
DELETE RANGE	4.43, 4.200	INPUT RF	4.214, 4.215, 6.85
DELETE VALUE	4.176	INS AFTER RANGE	4.43, 4.200
DEMODO	4.20	INS BEFORE RANGE	4.43, 4.200
DEMODO ON/OFF	4.20, 6.132	INSERT (peak list)	4.24
DETECTOR	4.17, 4.56, 4.102, 6.133	INSERT VALUE	4.176
DETECTOR AUTOPEAK	4.102, 6.133	INSTALL PRINTER	4.231
DETECTOR AVERAGE	4.104, 6.133	INTERACTIVE	4.29, 4.30
DETECTOR MAX PEAK	4.103, 6.133	ITEMS TO SAVE/RECALL	4.222, 6.118
DETECTOR MIN PEAK	4.103, 6.133	LAST SPAN	4.66
DETECTOR QPK	4.104, 6.133	LEFT LIMIT	4.50, 4.126, 6.40, 6.41
DETECTOR RMS	4.103, 6.133		





SET TO DEFAULT .....	4.234
SETTINGS COUPLED .....	4.52, 6.43
SGL SWEEP DISP OFF .....	4.82, 6.102
SHIFT X LIMIT LINE .....	4.176, 6.32
SHIFT Y LIMIT LINE .....	4.176, 6.38
SIGNAL COUNT .....	4.111, 6.42
SIGNAL STATISTIC .....	4.157
SIGNAL TRACK .....	4.65, 6.59
SINGLE MEAS .....	4.160, 6.101, 6.102
SINGLE SCAN .....	4.44, 6.101
SINGLE SWEEP .....	4.80, 6.101, 6.102
SOFT FRONT PANEL .....	4.210
SORT BY DELTA LIMIT .....	4.24
SORT BY FREQUENCY .....	4.24
SORT MODE .....	4.226
SOURCE CAL .....	4.238, 4.252
SOURCE ON/OFF .....	4.236, 6.121
SOURCE POWER .....	4.237, 4.251, 6.164, 6.167
SPAN MANUAL .....	4.66, 6.136
SPAN/RBW AUTO [50] .....	4.75, 6.125
SPAN/RBW MANUAL .....	4.76, 6.125
SPLIT SCREEN .....	4.181, 6.88
STANDARD DEVIATION .....	4.134, 6.67, 6.68
START .....	4.7, 4.64, 6.136
START LIMIT .....	4.134, 4.135, 6.41
STARTUP RECALL .....	4.224, 6.114
STATISTICS .....	4.212, 6.5
STEP SIZE .....	4.7, 6.135
STEP SIZE = FREQ .....	4.7
STEP SIZE MANUAL .....	4.7, 4.64, 6.137
STOP .....	4.7, 4.64, 6.136
STOP FINAL MEAS .....	4.30
STOP LIMIT .....	4.134, 4.135, 6.41
STOP SCAN .....	4.45, 6.7
SWEEP COUNT .....	4.81, 4.95, 6.158
SWEPTIME AUTO .....	4.74, 4.81, 6.157
SWEPTIME MANUAL .....	4.66, 4.73, 4.81, 6.157
SYSTEM INFO .....	4.211
SYSTEM MESSAGES .....	4.213, 6.187, 6.188
T1-T2 .....	4.105, 6.73
T1-T3 .....	4.105, 6.73
THRESHOLD .....	4.50, 4.126, 6.80, 6.81
TIME DOM POWER .....	4.132, 6.62, 6.64, 6.65, 6.67
TIME LINE 1/2 .....	4.178, 6.74
TIME+DATE .....	4.207, 6.187, 6.190
TIME+DATE ON/OFF .....	4.182, 6.91
TINT .....	4.184, 4.233, 6.89, 6.97
TOI .....	4.165, 6.51
TRACE MATH .....	4.105, 6.73
TRACE MATH OFF .....	4.105, 6.74
TRACE POSITION .....	4.105, 6.73
TRACK BW .....	4.65, 6.59
TRACK ON/OFF .....	4.65, 6.59
TRACK THRESHOLD .....	4.65, 6.60
TRACKING .....	4.236
TRANSDUCER .....	4.191
TRANSDUCER FACTOR .....	4.192, 6.129, 6.130
TRANSDUCER SET .....	4.192, 6.130, 6.131
TRIGGER OFFSET .....	4.84, 6.203
TUNE TO MARKER .....	4.49, 6.52
TV TRIG SETTINGS .....	4.90
TV TRIGGER ON/OFF .....	4.90, 6.161
UNIT .....	4.10, 4.68, 6.82, 6.205
USE CURR SETTINGS .....	4.44
USE SCAN TABLE .....	4.40, 6.154, 6.155, 6.156
USER DEFINED .....	4.232
USER PORT .....	4.203, 6.105
USER PORT IN/OUT .....	4.203, 6.105
VALUES .....	4.176, 6.31, 6.33, 6.36
VBW MODE LIN/LOG .....	4.79, 6.126
VERT SYNC .....	4.91, 6.204
VERT SYNC EVEN FIELD .....	4.91, 6.204
VERT SYNC ODD FIELD .....	4.91, 6.204
VIDEO .....	4.83, 6.202, 6.203
VIDEO BW AUTO .....	4.74, 6.126
VIDEO BW MANUAL .....	4.73, 6.126
VIDEO POL POS / NEG .....	4.91, 6.204
VIEW .....	4.55, 4.95, 6.93
VIEW TRANSDUCER .....	4.193
VOLT .....	4.68, 6.82
WATT .....	4.68, 6.82
X * RBW .....	4.63, 6.135, 6.136
X * SPAN .....	4.62, 6.135, 6.136
X OFFSET .....	4.171, 6.32
X-AXIS RANGE .....	4.159, 6.78
X-AXIS REF LEVEL .....	4.158, 6.77
Y OFFSET .....	4.171, 6.34, 6.37
Y-AXIS MAX VALUE .....	4.159, 6.78
Y-AXIS MIN VALUE .....	4.159, 6.78
ZERO SPAN .....	4.66, 6.136
ZOOM OFF .....	4.53
ZOOM x-AXIS .....	4.88
Span .....	4.66
Special characters .....	6.2
Spectrum analyzer mode .....	4.61
Split screen .....	3.8, 4.181
Squelch .....	4.121
SRE (service request enable register) .....	5.19
SRQ (service request) .....	5.19, 5.30
Standard deviation .....	4.134
Standard, mobile radio .....	4.140
Start frequency .....	4.64
Statistics .....	4.155
Status byte (STB) .....	5.19
Status information .....	3.5
IFOVL .....	3.5
MSG .....	3.5
OVEN .....	3.5
OVL D .....	3.5
UNCAL .....	3.5
Status Questionable	
TRANSDUCER register .....	5.29
Status register	
CONDition part .....	5.17
ENABLe part .....	5.17
ESE .....	5.20
ESR .....	5.20
EVENT part .....	5.17
NTRAnsition part .....	5.17
overview .....	5.18
PPE .....	5.20
PTRAnsition part .....	5.17
SRE .....	5.19
STATus QUEStionable .....	5.22
ACPLimit register .....	5.23
FREQuency register .....	5.24
LIMit register .....	5.25
LMARgin register .....	5.26
POWer register .....	5.27
SYNC .....	5.28
STATus:OPERation .....	5.21
STB .....	5.19
structure .....	5.16
sum bit .....	5.17
Status reporting system .....	5.16
resetting values .....	5.32
STB (status byte) .....	5.19
Stepsize .....	4.64
center frequency .....	4.62
coupling .....	4.64
receiver frequency .....	4.7
Stop frequency .....	4.64
Stop time for demodulation .....	4.122
Storing .....	8.1

- String ..... 5.12
- Subrange maxima list ..... 4.22
- Suffix ..... 5.9
- Sum bit ..... 5.17
- Supply voltage, external noise source ..... 4.187
- Sweep
- continue single sweep ..... 4.81
  - continuous ..... 4.80
  - count ..... 4.81
  - coupling ..... 4.71
  - free run ..... 4.46, 4.83
  - gated ..... 4.85, 4.86
  - settings ..... 4.80
  - single ..... 4.80
  - time ..... 4.66, 4.81
    - coupling ..... 4.74
- Switching cycles ..... 4.212
- Switching on/off ..... 1.14
- Sync signal ..... 4.91
- Syntax elements of commands ..... 5.12
- System messages ..... 4.213
- T**
- T1-T2 (trace info) ..... 3.5
- T1-T3 (trace info) ..... 3.5
- Table
- operation ..... 3.21
  - scrolling ..... 3.23
- TDF (enhancement table) ..... 3.6
- TDS (enhancement table) ..... 3.6
- Test
- functional ..... 1.16
  - selftest ..... 4.216
- Test receiver ..... 4.5
- Text parameter ..... 5.12
- TG I /AM IN ..... 8.12
- TG Q /FM IN ..... 8.12
- Third Order Intercept ..... 4.164
- Threshold
- line ..... 4.50, 4.126
  - signal tracking ..... 4.65
- Time ..... 4.182
- input ..... 4.207
- Time axis ..... 4.66
- Tint ..... 4.184, 4.233
- Title for the active diagram ..... 4.182
- TOI ..... 4.164
- Trace ..... 4.54, 4.55, 4.92, 4.93
- average ..... 4.94
  - averaging ..... 4.96
  - blank ..... 4.55, 4.95
  - Clear/Write ..... 4.55, 4.93
  - copy ..... 4.60, 4.99
  - freeze ..... 4.55, 4.95
  - math ..... 4.105
  - max hold ..... 4.55, 4.93
  - min hold ..... 4.58, 4.96
  - position for 0 difference ..... 4.105
  - select ..... 4.54, 4.92
  - signal tracking ..... 4.65
- Trace info ..... 3.5
- Tracking generator ..... 4.235
- Transducer ..... 4.190
- entry ..... 4.194
  - set ..... 4.198
  - switch on ..... 4.191
- Transmission measurement ..... 4.238, 4.252
- Transmission parameters RS-232-C/COM ..... 8.8
- TRG (enhancement table) ..... 3.6
- Trigger
- external ..... 4.46, 4.84
  - external gate ..... 4.86
  - free run ..... 4.46, 4.83
  - gated sweep ..... 4.87
  - IF power ..... 4.84
  - offset ..... 4.84
  - RF power ..... 4.90
  - scan ..... 4.46
  - slope ..... 4.46, 4.84
  - sweep ..... 4.83
  - video ..... 4.83
- TUNE TO MARKER ..... 4.49
- TV trigger ..... 4.90
- U**
- UNCAL ..... 3.5
- Unit
- level axis ..... 4.68
  - limit line ..... 4.174
- Unit (key) ..... 3.11
- Universal command ..... 8.5
- Upper case ..... 6.2
- User interface ..... 4.203
- User-Schnittstelle ..... 8.10
- V**
- Vertical sync signal ..... 4.91
- Video bandwidth ..... 4.73
- Video polarity ..... 4.91
- Video triggering ..... 4.83
- VIEW (trace info) ..... 3.5
- View trace ..... 4.95
- V-networks ..... 4.33
- W**
- Weighting modes ..... 4.18
- White space ..... 5.12
- Windows NT
- administrator ..... 1.17
  - login ..... 1.17
  - password ..... 1.17
- Z**
- Zero span ..... 4.66
- Zoom ..... 4.114
- amplitude ..... 4.55, 4.95
  - x-AXIS (gate signal) ..... 4.88